

LAVOR

SIMPLY STRONGER



2024|25

MAIN CATALOGUE
PROFESSIONAL



lavor.com

LAVOR

SIMPLY STRONGER

More strength, more power, more innovation.

This is what, day after day, forges the new LAVOR brand and that is realized in our products, ambassadors of our philosophy through cutting-edge technical and quality features.

Why do we do it?

We want to be by your side ever more.

Simply



LAVORWASH



Lavorwash is worldwide leader in cleaning industry since 1975 and offers a wide and complete range of cleaning machinery suitable for any kind of applications, both indoor and outdoor relying on a fortyfour-year experience.

Over the years, Lavorwash has grown to become a specialist manufacturer of professional and household cleaning systems, acquiring various leading brands and diversifying its own range to offer innovative products of excellence.

Lavorwash has production plants in Italy and around the world and nowadays it employs over 300 staff and has around 200 associates, with branches in several countries around the world such as France, the United Kingdom, Spain, Poland, Brazil and China.



Lavorwash is a company with a consolidated reputation at national and international levels. It operates locally through branches located around the world, delivering its products through importers, distributors, agent network and direct relations with large retailing chains

WATCH THE VIDEO





Cold water high-pressure cleaners

page **8**



Cold water high-pressure cleaners with combustion engine

page **56**



Hot water high-pressure cleaners

page **84**



Hot water high-pressure cleaners with combustion engine

page **112**



High-pressure pump units - Boilers

page **128**



Dry vacuum cleaners

page **142**



Wet & dry vacuum cleaners M Class

page **146**



Wet & dry vacuum cleaners Commercial Line

page **148**



Wet & dry vacuum cleaners Heavy Duty Line

page **174**

**Carpet cleaner - Spray extraction units**page **188**

**Industrial vacuum cleaners**page **202**

**Single disc machines**page **222**

**Walk-behind floor scrubber driers****Ride-on floor scrubber driers**page **230**

**Ride-on floor scrubber driers with
sweeping system**page **274**

**Walk-behind sweepers****Ride-on sweepers**page **280**

**Dry steam cleaners****Steam vacuum cleaners**page **312**

**Chemicals & sprayers**page **340**

Efficiency, reliability, safety and ease of use are the basic factors for a careful selection of a professional product. On the ground of these standards, Lavor has conceived professional line high-pressure cleaners, in order to match, through high-tech products, perfect hygiene and clean with time/labour saving.

Being Manufacturers: from experience to knowledge

In the high-pressure cleaners market companies are divided in those who buy components to assemble products and manufacturers, who have a continuous R&D on all product components. Lavorwash manufactures all the high-pressure cleaners components entirely and this allows: to spread product knowledge, culture and experience inside the company; to check the entire manufacturing cycle; to adopt possible improvements immediately; better sensitivity to market request adjusting product range design in real time.

What high pressure cleaner? Is it better pressure or delivery rate?

The right criteria to define the high-pressure cleaner performances is the washing effectiveness. The elements that influence this value are: delivery rate (water volume processed by the pump in a unity of time) and pressure (l/h water power on a surface). The higher the delivery rate, the faster the washing phase (less rinsing time); the higher the pressure, the deeper the washing (better dirt degreasing). It is often emphasized the pressure only (also because the pump size and the consequent manufacturing cost are cheaper), but delivery rate is as important as pressure.



What pump? Is it better a linear (crankshaft) or an axial one?

It does not exist a winning technology, because both solution can provide same performances and lifetime. What determines the pump quality is the quality of the project itself (linear or axial) and of the components used; for this reason Lavorwash decided to develop both technologies, taking into consideration a design that grants margin of safety and reliability.



- **Linear pump**

The movement of the (3) pistons occurs through a system of connecting rods and crankshaft. The longitudinal axle of the pistons (placed at the same level or linear) is perpendicular to the motor rotation axle. It is more versatile to bear high delivery rates (from 21 l/min) and it has a better self priming.



- **Water cooled motor**

Water flows through the Stainless steel coil around the motor, this allows a better thermal exchange (and so a cooling) than air also in those countries where inlet water could reaches 60°C. This allows a drop in operating temperature of the motor and pump mechanical elements, granting a better reliability and longer life.



- **Thermal valve**

When the gun trigger is released, the same water flows through the pump (by-pass) and it overheats and sooner or later this damages the valve seals. With this completely mechanical system, the thermal valve checks the temperature in the pump, opening/closing the by-pass circuit letting new and fresh water flow inside before the elements are damaged. Simple solution without electronic devices.



- **Total Stop**

Releasing the gun trigger the pump stops automatically avoiding element damages during the by-pass phase. Pulling the trigger, the high-pressure cleaner starts automatically. Max pump protection.



- **Low voltage and delayed Total Stop**

To avoid quick and multiple start and shut down of the motor/pump group whenever the gun trigger is pulled and released, this disposal delays the machine shut down of about 15 seconds. Prevention, energy saving, top safety and pump longer life.



- **Motor low rotation speed**

The electric motor transfers the same number of revolutions to the pump. With a 4 poles motor there is a lower rotation speed of the components (1400 RPM in case of 50Hz or 1750 RPM in case of 60 Hz) granting longer pump life. Extending lifetime solution.



- **Pump with nickel-plated brass head**

The nickel-plating treatment improves the basic features (greater hardness and improved resistance to the chemical products used in washing), reducing the deterioration caused by cavitation.

Mystic-R



MORE INFO



CHARACTERISTICS

- Three steel pistons, brass axial pump head with built-in by-pass valve. • Pump with double seal • Total stop. • Suction and delivery Stainless steel valves. • Detergent built-in tank for indirect suction. • Glycerine pressure gauge. • Hose holder. • Accessory holder. • Ergonomic handle.
- Power cable 5 m

TECHNICAL DATA

| | Mystic-R 1409 XP |
|------------------------|-----------------------------|
| code | 36084-00005 |
| rated/max pressure | 140/180 bar - 2030/2610 psi |
| max delivery flow rate | 540 l/h - 2.4 gpm |
| abs. power/supply | 2800 W/230V 1~50Hz |
| motor power | 2,0 kW |
| pump model | MPBX1/2800 rpm |
| T max water inlet | 40°C |
| dimension (cm)/weight | 43x50x85/28 Kg (61,6 lbs) |

PLUS



Axial motor pump with stainless steel pistons, brass head, double water seal



Glycerine bath pressure gauge to constantly monitor the operating pressure of the high pressure cleaner with reading guarantee



Integrated cleaning tank for indirect suction of the chemical product



Sturdy protective steel cover to protect the motor pump against accidental impacts

STANDARD EQUIPMENT

| | | | | |
|---|--|--|---|--|
|  <ul style="list-style-type: none"> • 00080-02576 Gun M22 |  <ul style="list-style-type: none"> • 00080-02770 Lance M22. |  <ul style="list-style-type: none"> • 10002-12433 High pressure nozzle set |  <ul style="list-style-type: none"> • 00080-02089 High pressure hose 8 m | |
|---|--|--|---|--|

OPTIONAL

| | | | | |
|--|---|--|--|--|
| <ul style="list-style-type: none"> • 10001-10252 High-pressure wall mount hose reel (hose not included) | <ul style="list-style-type: none"> • 00080-03481 Turbo nozzle head | <ul style="list-style-type: none"> • 00080-02981 Turbo lance M22 - 0,35 | <ul style="list-style-type: none"> • 00080-02957 Sand blasting lance M22 - 0,40 | |
|--|---|--|--|--|

Alaska



CHARACTERISTICS

- Three steel pistons, brass axial pump head with built-in by-pass valve.
- Pump with double seal
- Total Stop.
- Suction and delivery Stainless steel valves.
- Detergent built-in tank for indirect suction.
- Power cable holder.
- Accessory holder.
- Ergonomic handle.
- 1lt detergent tank.
- Power cable 5 m

TECHNICAL DATA

| | Alaska 1409 XP |
|------------------------|-----------------------------|
| code | 36087-00001 |
| rated/max pressure | 140/180 bar - 2030/2610 psi |
| max delivery flow rate | 540 l/h - 2.4 gpm |
| abs. power/supply | 2800 W/230V 1~50Hz |
| motor power | 2,0 kW |
| pump model | MPBX1/2800 rpm |
| T max water inlet | 40°C |
| dimension (cm)/weight | 35x40x87/28 Kg (61,6 lbs) |

PLUS



Axial motor pump with stainless steel pistons, brass head, double water seal



Convenient and functional rotary switch for easy switching on and off



Integrated cleaning tank with a capacity of 1 litre for indirect suction of the chemical with a level visible from the outside



Robust structure that gives great stability to the high pressure cleaner during use

STANDARD EQUIPMENT

| | | | | |
|---|--|--|---|--|
|  <ul style="list-style-type: none"> • 00080-02576 Gun M22 |  <ul style="list-style-type: none"> • 00080-02770 Lance M22. |  <ul style="list-style-type: none"> • 10002-12433 High pressure nozzle set |  <ul style="list-style-type: none"> • 00080-02089 High pressure hose 8 m | |
|---|--|--|---|--|

OPTIONAL

| | | | | |
|--|---|--|--|--|
| <ul style="list-style-type: none"> • 00080-02957 Sandblasting lance | <ul style="list-style-type: none"> • 00080-03481 Turbo nozzle head | <ul style="list-style-type: none"> • 00080-02981 Turbo lance M22 - 0,35 | <ul style="list-style-type: none"> • 00080-02957 Sand blasting lance M22 - 0,40 | |
|--|---|--|--|--|

HKA



MORE INFO



CHARACTERISTICS

- Three steel pistons, brass axial pump head with built-in by-pass valve. • Pump with double seal • Total Stop. • Suction and delivery Stainless steel valves.
- Detergent built-in tank for indirect suction. • Power cable holder. • Hose reel in pressure. • Accessory holder. • Ergonomic handle. • 1l detergent tank.

TECHNICAL DATA

| | HKA 1409 XP |
|------------------------|-----------------------------|
| code | 36087-00006 |
| rated/max pressure | 140/180 bar - 2030/2610 psi |
| max delivery flow rate | 540 l/h - 2.4 gpm |
| abs. power/supply | 2800 W/230V 1~50Hz |
| motor power | 2,0 kW |
| pump model | MPBX1/2800 rpm |
| T max water inlet | 40°C |
| dimension (cm)/weight | 35x40x96/28 Kg (61,6 lbs) |

PLUS



Axial motor pump with stainless steel pistons, brass head, double water seal



Practical hose reel connected under pressure to use only the necessary length of hose and to rewind it easily after use







Convenient and functional rotary switch for easy switching on and off



Integrated cleaning tank with a capacity of 1 litre for indirect suction of the chemical with a level visible from the outside

STANDARD EQUIPMENT

| | | | | |
|--|---|---|--|---|
|  <ul style="list-style-type: none"> • 00080-01701 Gun M22 - 3/8. |  <ul style="list-style-type: none"> • 00080-01724 Lance M22 high/low pressure |  <ul style="list-style-type: none"> • 00080-03186 Nozzle type 035 |  <ul style="list-style-type: none"> • 00080-02981 Turbo lance |  <ul style="list-style-type: none"> • 00080-02294 High pressure hose R1 8 m |
|--|---|---|--|---|

OPTIONAL

| | | | | |
|--|--|--|--|--|
| <ul style="list-style-type: none"> • 00080-02981 Turbo lance M22 - 0,35 | <ul style="list-style-type: none"> • 00080-02957 Sand blasting lance M22 - 0,40 | | | |
|--|--|--|--|--|

Maine



MORE INFO



CHARACTERISTICS

- Three steel pistons, brass axial pump head with built-in by-pass valve.
- Double water seal
- Total Stop.
- Suction and delivery Stainless steel valves.
- Integrated detergent suction with external suction probe.
- Power cable holder.
- High pressure hose holder.
- Accessory holder.
- Ergonomic handle.

TECHNICAL DATA

| | Maine 1409 XP |
|------------------------|-----------------------------|
| code | 36091-00001 |
| rated/max pressure | 140/180 bar - 2030/2610 psi |
| max delivery flow rate | 540 l/h - 2.4 gpm |
| abs. power/supply | 2800 W/230V 1~50Hz |
| motor power | 2,0 kW |
| pump model | MPBX1/2800 rpm |
| T max water inlet | 40°C |
| dimension (cm)/weight | 39x39x71/23 Kg (50,7 lbs) |

PLUS

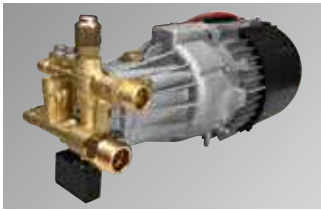

Axial motor pump with stainless steel pistons, brass head, double water seal



Ergonomic handle for lifting and manual transportation, it can also serve as a practical reel for electrical cable or high-pressure pipe



Convenient and functional rotary switch for easy switching on and off



Folding handle to reduce dimensions and to facilitate movement. If fully extended it makes it possible to pull the product on the rear wheels

STANDARD EQUIPMENT

| | | | | |
|---|---|--|--|--|
|  <ul style="list-style-type: none"> • 00080-02541 Gun M22 |  <ul style="list-style-type: none"> • 00080-02804 Lance M22 high/low pressure |  <ul style="list-style-type: none"> • 00080-02420 High pressure hose 8 m | | |
|---|---|--|--|--|

OPTIONAL

| | | | | |
|--|---|--|--|--|
| <ul style="list-style-type: none"> • 00080-02957 Sandblasting lance | <ul style="list-style-type: none"> • 00080-02981 Turbo lance | | | |
|--|---|--|--|--|

Maine HR



NEW

MORE INFO



CHARACTERISTICS

- Three steel pistons, brass axial pump head with built-in by-pass valve.
- Double water seal
- Total Stop.
- Suction and delivery Stainless steel valves.
- Integrated detergent suction with external probe.
- Power cable holder.
- Hose reel in pressure with h.p. hose 8m included.
- Accessory holder.
- Ergonomic handle.
- Hose reel in pressure
- Full assembled

TECHNICAL DATA

| | Maine HR 1409 XP |
|------------------------|-----------------------------|
| code | 36091-00016 |
| rated/max pressure | 140/180 bar - 2030/2610 psi |
| max delivery flow rate | 540 l/h - 2.4 gpm |
| abs. power/supply | 2800 W/230V 1~50Hz |
| motor power | 2,0 kW |
| pump model | MPBX1/2800 rpm |
| T max water inlet | 40°C |
| dimension (cm)/weight | 39x39x95/26 Kg (57 lbs) |

PLUS



Axial motor pump with stainless steel pistons, brass head, double water seal



Practical hose reel connected under pressure to use only the necessary length of hose and to rewind it easily after use



Convenient and functional rotary switch for easy switching on and off



Folding handle to reduce dimensions and to facilitate movement. If fully extended it makes it possible to pull the product on the rear wheels

STANDARD EQUIPMENT

| | | | | |
|---|---|---|--|--|
|  <ul style="list-style-type: none"> • 00080-02541 Gun M22 |  <ul style="list-style-type: none"> • 00080-02804 Lance M22 high/low pressure |  <ul style="list-style-type: none"> • 00080-02322 High pressure hose 10 m | | |
|---|---|---|--|--|

OPTIONAL

| | | | | |
|--|---|--|--|--|
| <ul style="list-style-type: none"> • 00080-02957 Sandblasting lance | <ul style="list-style-type: none"> • 00080-02981 Turbo lance | | | |
|--|---|--|--|--|

LMX



MORE INFO



CHARACTERISTICS

- Three ceramic coated pistons, brass axial pump head with built-in by-pass valve. • Total Stop. • Suction and delivery Stainless steel valves.
- Detergent built-in tank for indirect suction. • Pressure regulator. • Glycerine pressure gauge. • Hose reel in pressure. • Accessory holder.
- Ergonomic handle. • 7,5 lt. detergent tank.

TECHNICAL DATA

| | LMX 1211 XP | LMX 2007 XP |
|------------------------|-----------------------------|-----------------------------|
| code | 36067-00001 | 36067-00003 |
| rated/max pressure | 120/150 bar - 1740/2175 psi | 200/220 bar - 2900/3190 psi |
| max delivery flow rate | 660 l/h - 2.9 gpm | 420 l/h - 1.85 gpm |
| abs. power/supply | 3300 W/230V 1~50Hz | 3300 W/230V 1~50Hz |
| motor power | 2,3 kW | 2,3 kW |
| pump model | MPBX2/2800 rpm | MPBX2/2800 rpm |
| T max water inlet | 40°C | 40°C |
| dimension (cm)/weight | 59x37x87/28 Kg (61,6 lbs) | 59x37x87/28 Kg (61,6 lbs) |

PLUS



Oversized axial motor pump with integral ceramic pistons and brass head



Pressure regulating valve to vary the power of the water jet according to actual requirements

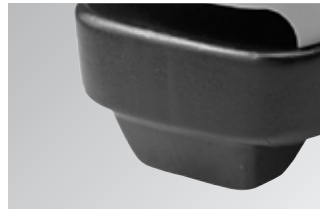

Detergent tank integrated into the frame with a capacity of 7.5 litres for indirect suction of the chemical product



Practical hose reel connected under pressure to use only the necessary length of hose and to rewind it easily after use

STANDARD EQUIPMENT

| | | | | |
|--|---|--|---|---|
|  <ul style="list-style-type: none"> • 00080-01701 Gun M22 - 3/8. |  <ul style="list-style-type: none"> • 00080-01724 Lance M22 high/low pressure |  <ul style="list-style-type: none"> • 00080-03189 Nozzle type 050 (mod. 1211 XP) |  <ul style="list-style-type: none"> • 00080-02956 Lance M22 high/low pressure with nozzle (mod. 2007 XP) |  <ul style="list-style-type: none"> • 00080-02258 High pressure hose 10 m |
|--|---|--|---|---|

OPTIONAL

| | | | | |
|--|--|---|--|--|
| <ul style="list-style-type: none"> • 00080-02258 10 m High pressure hose - 3/8" - Ø 5/16" - 310 bar | <ul style="list-style-type: none"> • 00080-02089 8 m High pressure hose - 1/4" M22 - Ø 1/4" 210 bar (mod. 1211) | <ul style="list-style-type: none"> • 00080-02966 Lance Turbo type 1 M22 - 0,45 (mod. 1211) | <ul style="list-style-type: none"> • 00080-02986 Lance Turbo M22 - 0,30 (mod. 2007) | <ul style="list-style-type: none"> • 00080-02957 Sandblasting lance |
|--|--|---|--|--|

Lite/Lite 2W



LITE 2W 1510 XP model



LITE 1510 XP model

MORE INFO



LITE

MORE INFO



LITE 2W

CHARACTERISTICS

- Three steel pistons, brass axial pump head with built-in by-pass valve
- Easy to transport thanks to a practical top grip and anti-vibration supports (only model Lite)
- Induction 2-pole motor (2800 rpm)
- Trolley with wheels Ø 250 mm (only 2W model)
- Glycerine pressure gauge.
- EASY START device
- Total Stop system
- Rotary switch
- Motor thermal protection

TECHNICAL DATA

| | LITE 1510 XP | LITE 2W 1510 XP |
|------------------------|-----------------------------|-----------------------------|
| code | 36016-00019 | 36016-00023 |
| rated/max pressure | 135/150 bar - 1958/2175 psi | 135/150 bar - 1958/2175 psi |
| max delivery flow rate | 600 l/h - 2.64 gpm | 600 l/h - 2.64 gpm |
| abs. power/supply | 2900 W/230V 1~50Hz | 2900 W/230V 1~50Hz |
| motor power | 2,1 kW | 2,1 kW |
| pump model | GXR/2800 rpm | GXR/2800 rpm |
| T max water inlet | 60°C | 60°C |
| dimension (cm)/weight | 26x47x37/25 Kg (55 lbs) | 60x43x93/30 Kg (66 lbs) |

PLUS



Axial motor pump with stainless steel pistons, brass head, double water seal



Convenient and functional rotary switch for easy switching on and off



Sturdy painted steel frame with anti-vibration feet for stability, ergonomic handle for easy movement (Lite). Trolley version (2W) with large rear wheels with a diameter of 250 mm to improve its transportation capacity



Hose reel (optional on the Trolley version) connected under pressure to use only the necessary length of hose and to rewind it easily after use

STANDARD EQUIPMENT

| | | | | |
|---|---|---|---|--|
|  <ul style="list-style-type: none"> • 00080-02576 Gun G1/4" M |  <ul style="list-style-type: none"> • 00080-01740 Lance M22 high/low pressure |  <ul style="list-style-type: none"> • 00080-03230 Nozzle type 030 |  <ul style="list-style-type: none"> • 10002-04140 H.p. hose 10 m | <ul style="list-style-type: none"> • 00070-00052 Detergent filter |
|---|---|---|---|--|

OPTIONAL

| | | | | |
|---|---|---|---|--|
| <ul style="list-style-type: none"> • 10002-03655 Turbo lance | <ul style="list-style-type: none"> • 10002-04322 2 Wheels cart | <ul style="list-style-type: none"> • 00080-01541 Hose-reel kit (only 2W model) | <ul style="list-style-type: none"> • 00058-00632 25 m pipe cleaning hose | |
|---|---|---|---|--|

Lite PRO/Lite PRO 2W



LITE PRO 2W 1510 LP model



LITE PRO 1510 LP model



MORE INFO



LITE PRO

MORE INFO



LITE PRO 2W

CHARACTERISTICS

- Three full ceramic pistons, brass linear pump head with by-pass valve
- Easy to transport thanks to a practical top grip and anti-vibration supports (only model Lite)
- Trolley with wheels Ø 250 mm (only 2W model)
- 4-pole motor (1400 rpm)
- Glycerine pressure gauge.
- EASY START device
- Total Stop system
- Rotary switch
- Motor thermal protection

TECHNICAL DATA

| | LITE PRO 1510 XP | LITE PRO 2W 1510 XP |
|------------------------|-----------------------------|-----------------------------|
| code | 36016-00020 | 36016-00024 |
| rated/max pressure | 140/150 bar - 2030/2175 psi | 140/150 bar - 2030/2175 psi |
| max delivery flow rate | 600 l/h - 2.64 gpm | 600 l/h - 2.64 gpm |
| abs. power/supply | 2900 W/230V 1~50Hz | 2900 W/230V 1~50Hz |
| motor power | 2,1 kW | 2,1 kW |
| pump model | CL3.1/1400 rpm | CL3.1/1400 rpm |
| T max water inlet | 60 °C | 60 °C |
| dimension (cm)/weight | 26x47x37/35 Kg (77 lbs) | 60x43x93/40 Kg (88 lbs) |

PLUS



4 pole induction motor (1400 rpm): the low rotation speed significantly extends the life of the components inside the motor pump, guaranteeing greater efficiency and silence



Integral ceramic self-priming three-piston linear pump, the best solution for a professional product



Sturdy painted steel frame with anti-vibration feet for stability, ergonomic handle for easy movement (Lite). Trolley version (2W) with large rear wheels with a diameter of 250 mm to improve its transportation capacity



Hose reel (optional on the Trolley version) connected under pressure to use only the necessary length of hose and to rewind it easily after use

STANDARD EQUIPMENT

| | | | | |
|--|---|---|---|--|
|  <ul style="list-style-type: none"> • 00080-01009 Gun M22 - 3/8. |  <ul style="list-style-type: none"> • 10002-03553 Lance M22 high/low pressure |  <ul style="list-style-type: none"> • 00080-01368 Stainless steel nozzle type 040 |  <ul style="list-style-type: none"> • 00014-00276 High pressure hose 10 m | <ul style="list-style-type: none"> • 00070-00052 Detergent filter |
|--|---|---|---|--|

OPTIONAL

| | | | | |
|---|---|---|---|--|
| <ul style="list-style-type: none"> • 10002-03624 Turbo lance | <ul style="list-style-type: none"> • 10002-04322 2W cart | <ul style="list-style-type: none"> • 00080-01541 Hose-reel kit (only 2W model) | <ul style="list-style-type: none"> • 00058-00632 25 m pipe cleaning hose | |
|---|---|---|---|--|

Bolt



MORE INFO



CHARACTERISTICS

- Three ceramic coated pistons, overdimensioned brass linear pump head with built-in by-pass valve.
- Total stop
- Suction and delivery Stainless steel valves.
- Integrated detergent suction with external suction probe
- Pressure regulator.
- Glycerine pressure gauge.
- Accessory holder.
- Ergonomic handle.

TECHNICAL DATA

| | Bolt 1510 LP |
|------------------------|-----------------------------|
| code | 36086-00027 |
| rated/max pressure | 150/180 bar - 2175/2610 psi |
| max delivery flow rate | 540 l/h - 2.4 gpm |
| abs. power/supply | 2800 W/230V 1~50Hz |
| motor power | 2,1 kW |
| pump model | MP4/1400 rpm |
| T max water inlet | 40°C |
| dimension (cm)/weight | 43x50x85/36 Kg (79,3 lbs) |

PLUS



Professional motor pump with 4-pole motor (1400 rpm) and self-priming linear pump: the low rotation speed significantly extends the life of the components inside the motor pump, guaranteeing greater efficiency and silence



Convenient and functional rotary switch for easy switching on and off



Pressure regulating valve to vary the power of the water jet according to actual requirements



Practical hose reel (optional) connected under pressure to use only the necessary length of hose and to rewind it easily after use

STANDARD EQUIPMENT

| | | | | |
|---|---|--|--|--|
|  <ul style="list-style-type: none"> • 00080-02541 Gun M22 |  <ul style="list-style-type: none"> • 00080-02988 Lance M22 high/low pressure |  <ul style="list-style-type: none"> • 00080-02389 High pressure hose R1 10 m |  <ul style="list-style-type: none"> • 00070-00479 Water filter 3/4F-3/4M | |
|---|---|--|--|--|

OPTIONAL

| | | | | |
|---|--|--|--|--|
| <ul style="list-style-type: none"> • 10002-08676 Hose reel set (hose not included) | <ul style="list-style-type: none"> • 10001-10148 Hose reel with 15 m R1 hose included | <ul style="list-style-type: none"> • 00080-02986 Lance Turbo M22 - 0,30 | <ul style="list-style-type: none"> • 00080-02957 Sandblasting lance | |
|---|--|--|--|--|

Arizona



MORE INFO



CHARACTERISTICS

- 4 poles electrical motor (1400 rpm) with thermal protection.
- Three ceramic coated pistons, brass linear pump head with built-in by-pass valve.
- Suction and delivery Stainless steel valves.
- Detergent built-in tank for indirect suction.
- Pressure regulator.
- Glycerine pressure gauge.
- Hose reel **(optional)**.
- Accessory holder.
- Hose-holder.
- Ergonomic handle.
- 7,5 lt. detergent tank.

TECHNICAL DATA

| | Arizona 1209 LP | Arizona 1311 LP | Arizona 1311 LP with hose reel |
|------------------------|-----------------------------|-----------------------------|--------------------------------|
| code | 36085-00025 | 36085-00028 | 36085-00032 |
| rated/max pressure | 120/150 bar - 1740/2175 psi | 130/150 bar - 1885/2175 psi | 130/150 bar - 1885/2175 psi |
| max delivery flow rate | 510 l/h - 2.24 gpm | 660 l/h - 2.90 gpm | 660 l/h - 2.90 gpm |
| abs. power/supply | 2300 W/230V 1~50Hz | 2900 W/230V 1~50Hz | 2900 W/230V 1~50Hz |
| motor power | 1,7 kW | 2,1 kW | 2,1 kW |
| pump model | MP3/1400 rpm | MP3/1400 rpm | MP3/1400 rpm |
| T max water inlet | 40°C | 40°C | 40°C |
| dimension (cm)/weight | 59x37x87/26 Kg (57 lbs) | 59x37x87/28 Kg (61 lbs) | 59x37x87/28 Kg (61 lbs) |

PLUS



Professional motor pump with 4-pole motor (1400 rpm) and self-priming linear pump: the low rotation speed significantly extends the life of the components inside the motor pump, guaranteeing greater efficiency and silence



Pressure regulating valve to vary the power of the water jet according to actual requirements



Convenient and functional rotary switch for easy switching on and off



Detergent tank integrated into the frame with a capacity of 7.5 litres for indirect suction of the chemical product

STANDARD EQUIPMENT

| | | | | |
|---|---|--|---|---|
|  <ul style="list-style-type: none"> • 00080-02576 Gun M22 |  <ul style="list-style-type: none"> • 00080-01701 Gun M22 - 3/8. (mod. 36085-00032) |  <ul style="list-style-type: none"> • 00080-02770 Lance M22. |  <ul style="list-style-type: none"> • 10002-12433 High pressure nozzle set (mod. 1209) • 10002-12357 High pressure nozzle set (mod. 1311) |  <ul style="list-style-type: none"> • 00080-02332 High pressure hose 8 m • 00080-02258 High pressure hose 8 m (mod. 36085-00032) |
|---|---|--|---|---|

OPTIONAL

| | | | | |
|---|---|---|--|--|
| <ul style="list-style-type: none"> • 00080-03481 Turbo nozzle head | <ul style="list-style-type: none"> • 00080-02089 8 m High pressure hose - 1/4" M22 - Ø 1/4" 210 bar (mod. 1311 LP) | <ul style="list-style-type: none"> • 00080-02966 Lance Turbo type 1 M22 - 0,45 | <ul style="list-style-type: none"> • 00080-02957 Sandblasting lance | |
|---|---|---|--|--|

HA



MORE INFO



CHARACTERISTICS

- 4 poles electrical motor (1400 rpm) with thermal protection.
- Three ceramic coated pistons, brass linear pump head with built-in by-pass valve.
- Suction and delivery Stainless steel valves.
- Detergent built-in tank for indirect suction.
- Pressure regulator.
- Glycerine pressure gauge.
- Accessory holder.
- Hose-holder.
- Ergonomic handle.
- 7,5 l detergent tank.

TECHNICAL DATA

| | HA 1311 LP | HA 1510 LP |
|------------------------|-----------------------------|-----------------------------|
| code | 36085-00039 | 36085-00044 |
| rated/max pressure | 130/150 bar - 1885/2175 psi | 150/160 bar - 2175/2320 psi |
| max delivery flow rate | 660 l/h - 2.9 gpm | 600 l/h - 2.64 gpm |
| abs. power/supply | 2900 W/230V 1~50Hz | 3000 W/230V 1~50Hz |
| motor power | 2,1 kW | 2,1 kW |
| pump model | MP3/1400 rpm | MP3/1400 rpm |
| T max water inlet | 40°C | 40°C |
| dimension (cm)/weight | 59x37x87/28 Kg (61 lbs) | 59x37x87/28 Kg (61 lbs) |

PLUS



Professional motor pump with 4-pole motor (1400 rpm) and self-priming linear pump: the low rotation speed significantly extends the life of the components inside the motor pump, guaranteeing greater efficiency and silence



Pressure regulating valve to vary the power of the water jet according to actual requirements







Convenient and functional rotary switch for easy switching on and off



Detergent tank integrated into the frame with a capacity of 7.5 litres for indirect suction of the chemical product

STANDARD EQUIPMENT

| | | | | |
|--|---|--|--|--|
|  <ul style="list-style-type: none"> • 00080-01701 Gun M22 - 3/8. |  <ul style="list-style-type: none"> • 00080-01724 Lance M22 high/low pressure |  <ul style="list-style-type: none"> • 00080-03188 Nozzle type 045 (mod. 1311) • 00080-03185 Nozzle type 030 (mod. 1510) |  <ul style="list-style-type: none"> • 00080-02254 High pressure hose 8 m | |
|--|---|--|--|--|

OPTIONAL

| | | | | |
|---|--|---|--|--|
| <ul style="list-style-type: none"> • 00080-03481 Turbo nozzle head | <ul style="list-style-type: none"> • 00080-02254 8 m High pressure hose - 3/8" M22 - Ø 1/4" - 210 bar | <ul style="list-style-type: none"> • Turbo Lance code: 00080-02966 - (mod. 1311) 00080-02986 - (mod. 1510) | <ul style="list-style-type: none"> • 00080-02957 Sandblasting lance | |
|---|--|---|--|--|

Tucson



Models:
1713 LP/2017 LP



Models:
1211 LP/1509 LP



Models:
1713 LP/2017 LP

MORE INFO



CHARACTERISTICS

- 4 poles electrical motor (1400 rpm) with thermal protection (mod. 1 ph) • 4 poles electrical motor (1400 rpm) with thermal protection and water cooling (mod. 3 ph) • Three ceramic coated pistons (Tucson 1211/1509). Three full ceramic pistons (Tucson 1713/2017) • Suction and delivery Stainless steel valves. • Low voltage and delayed Total Stop (mod. 3 ph) • Detergent built-in tank for indirect suction (2,8 lt.). • Pressure regulator. • Glycerine pressure gauge.

TECHNICAL DATA

| | Tucson 1211 LP | Tucson 1509 LP | Tucson 1713 LP | Tucson 2017 LP |
|------------------------|-----------------------------|-----------------------------|-----------------------------|-----------------------------|
| code | 36089-00001 | 36089-00002 | 36089-00003 | 36089-00004 |
| rated/max pressure | 120/150 bar - 1740/2175 psi | 150/160 bar - 2175/2320 psi | 170/190 bar - 2465/2755 psi | 200/230 bar - 2900/3335 psi |
| max delivery flow rate | 660 l/h - 2.9 gpm | 540 l/h - 2.37 gpm | 780 l/h - 3.43 gpm | 1020 l/h - 4.4 gpm |
| abs. power/supply | 3000 W/230V 1~50Hz | 3000 W/230V 1~50Hz | 5200 W/400V 3~50Hz | 7500 W/400V 3~50Hz |
| motor power | 2,2 kW | 2,2 kW | 4,0 kW | 5,5 kW |
| pump model | MP3/1400 rpm | MP3/1400 rpm | MPW3.5/1400 rpm | MPW3.5/1400 rpm |
| T max water inlet | 40°C | 40°C | 40°C | 40°C |
| dimension (cm)/weight | 76x41x75/33 Kg (72,6 lbs) | 76x41x75/33 Kg (72,6 lbs) | 76x41x75/42 Kg (92,4 lbs) | 76x41x75/44 Kg (96,8 lbs) |

PLUS

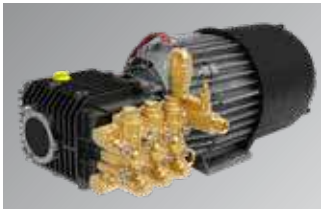

Professional motor pump with 4-pole motor (1400 rpm) and self-priming linear pump: the low rotation speed significantly extends the life of the components inside the motor pump, guaranteeing greater efficiency and silence



Pressure regulating valve to vary the power of the water jet according to actual requirements







Total stop delayed and in low voltage: the device delays the shutdown of the high pressure cleaner by 15 seconds from the last release of the gun lever, for safety, energy saving and prevention of faults or overheating of the motor pump



Integrated cleaning tank with a capacity of 2.8 litres for indirect suction of the chemical product

STANDARD EQUIPMENT

| | | | | |
|--|---|---|--|---|
|  <ul style="list-style-type: none"> • 00080-01701 Gun M22 - 3/8 (mod. 1211/1509) |  <ul style="list-style-type: none"> • 00080-01695 Gun M22 - 3/8 with rotating coupling (mod. 1713/2017) |  <ul style="list-style-type: none"> • 00080-01724 Lance M22 high/low pressure |  <ul style="list-style-type: none"> • 00080-03188 Nozzle type 045 (mod. 1211) • 00080-03185 Nozzle type 030 (mod. 1509) • 00080-03190 Nozzle type 055 (mod. 1713/2017) |  <ul style="list-style-type: none"> • 00080-02347 High pressure hose 10 m (mod. 1713/2017) • 00080-02254 High pressure hose 8 m (mod. 1211/1509) |
|--|---|---|--|---|

OPTIONAL

| | | | | |
|---|---|--|---|--|
| <ul style="list-style-type: none"> • 00080-03481 Turbo nozzle head | <ul style="list-style-type: none"> • 00080-02254 8 m High pressure hose - 3/8" M22 - Ø 1/4" - 210 bar (mod. 1211/1509) | <ul style="list-style-type: none"> • High pressure hose code: 00080-02258 10 m - 310 bar 00080-02261 20 m - 400 bar 00080-02262 20 m - 400 bar 00080-02263 10 m - 400 bar food industry | <ul style="list-style-type: none"> • Turbo Lance code: 00080-02966 - (mod. 1211/2017) 00080-02967 - (mod. 1713/2017) 00080-02986 - (mod. 1509) | <ul style="list-style-type: none"> • Sand-blasting lance code: 00080-02957 (mod. 1211) 00080-02958 (mod. 1713/2017) |
|---|---|--|---|--|

HNR



Models:
1713 LP/2017 LP



Model:
1509 LP



Models:
1713 LP/2017 LP

MORE INFO



CHARACTERISTICS

- 4 poles electrical motor (1400 rpm) with thermal protection and water cooling (mod. 1713 LP/2017 LP) • Three ceramic coated pistons (mod. 1509 LP).
- Three full ceramic pistons (mod. 1713 LP/2017 LP).
- Built-in by-pass valve nickel plating brass linear pump head with high temperature water seals and bushing.
- Suction and delivery Stainless steel valves.
- Low voltage and delayed Total Stop (mod. 1713 LP/2017 LP)
- Detergent built-in tank for indirect suction (2,8 lt.).
- Pressure regulator.
- Glycerine pressure gauge.
- Hose-reel.

TECHNICAL DATA

| | HNR 1509 LP | HNR 1713 LP | HNR 2017 LP |
|------------------------|-----------------------------|-----------------------------|-----------------------------|
| code | 36089-00013 | 36089-00014 | 36089-00015 |
| rated/max pressure | 150/160 bar - 2175/2320 psi | 170/190 bar - 2465/2755 psi | 200/230 bar - 2900/3335 psi |
| max delivery flow rate | 540 l/h - 2.37 gpm | 780 l/h - 3.43 gpm | 1020 l/h - 4.4 gpm |
| abs. power/supply | 3000 W/230V 1~50Hz | 5200 W/400V 3~50Hz | 7500 W/400V 3~50Hz |
| motor power | 2,2 kW | 4,0 kW | 5,5 kW |
| pump model | MP3 Ni/1400 rpm | MPW3.5 Ni/1400 rpm | MPW3.5 Ni/1400 rpm |
| T max water inlet | 60°C | 60°C | 60°C |
| dimension (cm)/weight | 76x40x75/33 Kg (72,6 lbs) | 76x40x75/42 Kg (92,4 lbs) | 76x40x75/44 Kg (96,8 lbs) |

PLUS



Professional motor pump with 4-pole motor (1400 rpm) and self-priming linear pump: the low rotation speed significantly extends the life of the components inside the motor pump, guaranteeing greater efficiency and silence



Pressure regulating valve to vary the power of the water jet according to actual requirements







Total stop delayed and in low voltage: the device delays the shutdown of the high pressure cleaner by 15 seconds from the last release of the gun lever, for safety, energy saving and prevention of faults or overheating of the motor pump



Integrated cleaning tank with a capacity of 2.8 litres for indirect suction of the chemical product

STANDARD EQUIPMENT

| | | | | |
|--|---|---|--|--|
|  <ul style="list-style-type: none"> • 00080-01695 Gun M22 - 3/8 with rotating coupling |  <ul style="list-style-type: none"> • 00080-01724 Lance M22 high/low pressure |  <ul style="list-style-type: none"> • 00080-03190 Nozzle type 055 (mod. 1713/2017) • 00080-03185 Nozzle type 030 (mod. 1509) |  <ul style="list-style-type: none"> • 00080-02258 High pressure hose 10 m (mod. 1509) • 00080-02259 High pressure hose 10 m (mod. 1713/2017) | |
|--|---|---|--|--|

OPTIONAL

| | | | | |
|---|--|--|--|--|
| <ul style="list-style-type: none"> • 00080-03481 Turbo nozzle head | <ul style="list-style-type: none"> • High pressure hose code: 00080-02258 10 m - 310 bar 00080-02261 20 m - 400 bar 00080-02262 20 m - 400 bar 00080-02263 10 m - 400 bar food industry | <ul style="list-style-type: none"> • Turbo Lance code: 00080-02967 - (mod. 1713/2017) 00080-02986 - (mod. 1509) | <ul style="list-style-type: none"> • Sand-blasting lance code: 00080-02957 (mod. 1509) 00080-02958 (mod. 1713/2017) | |
|---|--|--|--|--|

Tucson XL



MORE INFO



CHARACTERISTICS

- 4 poles electrical motor (1400 rpm) with thermal protection and water cooling.
- Three full ceramic pistons, brass linear pump head with by-pass valve.
- Low voltage and delayed Total Stop.
- Suction and delivery Stainless steel valves.
- Detergent built-in tank for indirect suction (2,8 lt.).
- Pressure regulator.
- Glycerine pressure gauge.
- Hose-reel.

TECHNICAL DATA

| | Tucson XL 2015 LP | Tucson XL 2021 LP | Tucson XL 2515 LP |
|------------------------|-----------------------------|-----------------------------|-----------------------------|
| code | 36090-00001 | 36090-00002 | 36090-00003 |
| rated/max pressure | 200/230 bar - 2900/3335 psi | 200/230 bar - 2900/3335 psi | 250/280 bar - 3600/4061 psi |
| max delivery flow rate | 900 l/h - 3.96 gpm | 1260 l/h - 5.55 gpm | 900 l/h - 3.96 gpm |
| abs. power/supply | 7000 W/400V 3~50Hz | 9400 W/400V 3~50Hz | 9400 W/400V 3~50Hz |
| motor power | 5,5 kW | 7,5 kW | 7,5 kW |
| pump model | CL6/1400 rpm | CL6/1400 rpm | CL6/1400 rpm |
| T max water inlet | 60°C | 60°C | 60°C |
| dimension (cm)/weight | 61x40x91/69 Kg (152 lbs) | 61x40x91/70 Kg (154 lbs) | 61x40x91/70 Kg (154 lbs) |

PLUS



New CL 6.0 self-priming pump with three pistons in integral ceramic, tapered roller bearings, double oil viewer and brass head



New flanged pressure regulating valve L3.1, internal passages resized to ensure correct operation even in high operating flow conditions







Total stop delayed and in low voltage: the device delays the shutdown of the high pressure cleaner by 15 seconds from the last release of the gun lever, for safety, energy saving and prevention of faults or overheating of the motor pump.



Integrated cleaning tank with a capacity of 2.8 litres for indirect suction of the chemical product

STANDARD EQUIPMENT

| | | | | |
|--|---|---|--|--|
|  <ul style="list-style-type: none"> • 00080-01695 Gun M22 - 3/8 with rotating coupling |  <ul style="list-style-type: none"> • 00080-01724 Lance M22 high/low pressure |  <ul style="list-style-type: none"> • 00080-03188 Nozzle type 045 (mod. 2015) • 00080-03193 Nozzle type 070 (mod. 2021) • 00080-03187 Nozzle type 040 (mod. 2515) |  <ul style="list-style-type: none"> • 00080-02259 High pressure hose 10 m | |
|--|---|---|--|--|

OPTIONAL

| | | | | |
|---|--|--|--|--|
| <ul style="list-style-type: none"> • 00080-03481 Turbo nozzle head | <ul style="list-style-type: none"> • High pressure hose code: 00080-02258 10 m - 310 bar 00080-02261 20 m - 400 bar 00080-02262 20 m - 400 bar 00080-02263 10 m - 400 bar food industry | <ul style="list-style-type: none"> • Turbo Lance code: 00080-02966 - (mod. 2015/2515) 00080-02968 - (mod. 2021) | <ul style="list-style-type: none"> • Sand-blasting lance code: 00080-02957 (mod. 2015/2515) 00080-02959 (mod. 2021) | |
|---|--|--|--|--|

HNR XL



MORE INFO



CHARACTERISTICS

- 4 poles electrical motor (1400 rpm) with thermal protection and water cooling.
- Three full ceramic pistons, Nickel plating brass linear pump head with high temperature water seals and bushing.
- Low voltage and delayed Total Stop.
- Suction and delivery Stainless steel valves.
- Detergent built-in tank for indirect suction (2,8 lt.).
- Pressure regulator.
- Glycerine pressure gauge.

TECHNICAL DATA

| | HNR XL 2015 LP | HNR XL 2021 LP | HNR XL 2515 LP |
|------------------------|-----------------------------|-----------------------------|-----------------------------|
| code | 36090-00008 | 36090-00009 | 36090-00010 |
| rated/max pressure | 200/230 bar - 2900/3335 psi | 200/230 bar - 2900/3335 psi | 250/280 bar - 3600/4061 psi |
| max delivery flow rate | 900 l/h - 3.96 gpm | 1260 l/h - 5.55 gpm | 900 l/h - 3.96 gpm |
| abs. power/supply | 7000 W/400V 3~50Hz | 9400 W/400V 3~50Hz | 9400 W/400V 3~50Hz |
| motor power | 5,5 kW | 7,5 kW | 7,5 kW |
| pump model | CL6 Ni/1400 rpm | CL6 Ni/1400 rpm | CL6 Ni/1400 rpm |
| T max water inlet | 60°C | 60°C | 60°C |
| dimension (cm)/weight | 61x40x91/69 Kg (152 lbs) | 61x40x91/70 Kg (154 lbs) | 61x40x91/70 Kg (154 lbs) |

PLUS



New CL 6.0 self-priming pump with three pistons in integral ceramic, tapered roller bearings, double oil viewer and brass head



New flanged pressure regulating valve L3.1, internal passages resized to ensure correct operation even in high operating flow conditions





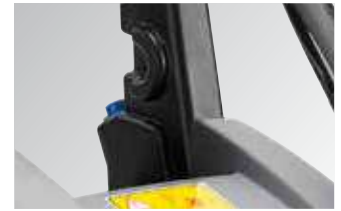

Total stop delayed and in low voltage: the device delays the shutdown of the high pressure cleaner by 15 seconds from the last release of the gun lever, for safety, energy saving and prevention of faults or overheating of the motor pump



Integrated cleaning tank with a capacity of 2.8 litres for indirect suction of the chemical product

STANDARD EQUIPMENT

| | | | | |
|--|---|---|--|--|
|  <ul style="list-style-type: none"> • 00080-01695 Gun M22 - 3/8 with rotating coupling |  <ul style="list-style-type: none"> • 00080-01724 Lance M22 high/low pressure |  <ul style="list-style-type: none"> • 00080-03188 Nozzle type 045 (mod. 2015) • 00080-03193 Nozzle type 070 (mod. 2021) • 00080-03187 Nozzle type 040 (mod. 2515) |  <ul style="list-style-type: none"> • 00080-02347 High pressure hose 10 m | |
|--|---|---|--|--|

OPTIONAL

| | | | | |
|---|--|--|--|--|
| <ul style="list-style-type: none"> • 00080-03481 Turbo nozzle head | <ul style="list-style-type: none"> • High pressure hose code: 00080-02258 10 m - 310 bar 00080-02261 20 m - 400 bar 00080-02262 20 m - 400 bar 00080-02263 10 m - 400 bar food industry | <ul style="list-style-type: none"> • Turbo Lance code: 00080-02966 - (mod. 2015/2515) 00080-02986 - (mod. 2021) | <ul style="list-style-type: none"> • Sand-blasting lance code: 00080-02957 (mod. 2015/2515) 00080-02959 (mod. 2021) | |
|---|--|--|--|--|

Columbia-R



Model:
2015 LP



Model:
1211 LP



Model:
2015 LP

MORE INFO



CHARACTERISTICS

- 4 poles electrical motor (1400 rpm) with thermal protection and water cooling (3 ph model).
- Three ceramic coated pistons (1 ph model), full ceramic pistons (3 ph model), brass linear pump head with built-in by-pass valve.
- Low voltage and delayed Total Stop (3 ph model).
- Suction and delivery Stainless steel valves.
- Integrated detergent suction with external suction probe.
- Pressure regulator.
- Glycerine pressure gauge.
- Hose reel (**optional**).
- Accessory holder.
- Power cable holder.
- Steel frame.
- Steel cover.

TECHNICAL DATA

| | Columbia R 1211 LP | Columbia R 2015 LP |
|------------------------|-----------------------------|-----------------------------|
| code | 36082-00154 | 36082-00155 |
| rated/max pressure | 120/150 bar - 1740/2175 psi | 200/230 bar - 2900/3335 psi |
| max delivery flow rate | 660 l/h - 2.91 gpm | 900 l/h - 3.96 gpm |
| abs. power/supply | 3000 W/230V 1~50Hz | 7000 W/400V 3~50Hz |
| motor power | 2,2 kW | 5,5 kW |
| pump model | MP3/1400 rpm | CL6 Ni/1400 rpm |
| T max water inlet | 60°C | 60°C |
| dimension (cm)/weight | 50x90x83/37 Kg (81 lbs) | 50x90x83/51 Kg (112 lbs) |

PLUS



Professional motor pump with 4-pole motor (1400 rpm) and self-priming linear pump: the low rotation speed significantly extends the life of the components inside the motor pump, guaranteeing greater efficiency and silence



Painted steel frame with support foot for stable positioning and ergonomic handle for easy movement





Sturdy protective steel cover to protect the motor pump against accidental impacts



Practical hose reel (optional) connected under pressure to use only the necessary length of hose and to rewind it easily after use

STANDARD EQUIPMENT

| | | | | |
|--|---|---|---|---|
|  <ul style="list-style-type: none"> • 00080-01701 Gun M22 - 3/8 (mod. 1211). |  <ul style="list-style-type: none"> • 00080-01695 Gun M22 - 3/8 with rotating coupling (mod. 2015). |  <ul style="list-style-type: none"> • 00080-01724 Lance M22 high/low pressure |  <ul style="list-style-type: none"> • 00080-03188 Nozzle type 045 |  <ul style="list-style-type: none"> • 00080-02347 High pressure hose 10 m (mod. 2015) • 00080-02254 High pressure hose 8 m (mod. 1211) |
|--|---|---|---|---|

OPTIONAL

| | | | | |
|---|--|--|---|--|
| <ul style="list-style-type: none"> • 10001-10249 High-pressure hose reel (hose not included) | <ul style="list-style-type: none"> • 00080-02254 8 m High pressure hose - 3/8" M22 - Ø 1/4" - 210 bar (mod. 1211) | <ul style="list-style-type: none"> • High pressure hose code: 00080-02258 10 m - 310 bar 00080-02261 20 m - 400 bar 00080-02262 20 m - 400 bar 00080-02263 10 m - 400 bar food industry (mod. 2015) | <ul style="list-style-type: none"> • 00080-02966 Lance Turbo type 1 M22 - 0,45 | <ul style="list-style-type: none"> • 00080-02957 Sandblasting lance |
|---|--|--|---|--|

HCR



Models:
1515 LP/2015 LP
2021 LP/2515 LP

MORE INFO



CHARACTERISTICS

- 4 poles electrical motor (1400 rpm) with thermal protection and water cooling.
- Three ceramic pistons, Nickel plating brass linear pump head (model 1515/2015/2021/2515) brass linear pump head (model 1211) with high temperature water seals and flanged valve and pressure regulator.
- Suction and delivery Stainless steel valves.
- Integrated elastic joint, for best pump coupling
- Low voltage and delayed Total Stop
- Integrated detergent suction with external suction probe.
- Glycerine pressure gauge.
- Hose reel (**optional**).
- Galvanized steel frame.
- Stainless Steel covers.

TECHNICAL DATA

| | HCR 1211 LP | HCR 1515 LP | HCR 2015 LP | HCR 2021 LP | HCR 2515 LP |
|------------------------|-----------------------------|-----------------------------|-----------------------------|-----------------------------|-----------------------------|
| code | 36082-00170 | 36082-00137 | 36082-00138 | 36082-00139 | 36082-00140 |
| rated/max pressure | 120/150 bar - 1740/2175 psi | 150/180 bar - 2175/2610 psi | 200/230 bar - 2900/3335 psi | 200/230 bar - 2900/3335 psi | 250/280 bar - 3600/4061 psi |
| max delivery flow rate | 660 l/h - 2.9 gpm | 900 l/h - 3.96 gpm | 900 l/h - 3.96 gpm | 1260 l/h - 5.55 gpm | 900 l/h - 3.96 gpm |
| abs. power/supply | 3000 W/230V 1~50Hz | 5000 W/400V 3~50Hz | 7000 W/400V 3~50Hz | 9400 W/400V 3~50Hz | 8500 W/400V 3~50Hz |
| motor power | 2,2 kW | 4,0 kW | 5,5 kW | 7,5 kW | 7,5 kW |
| pump model | CL3.8/1400 rpm | CL6 Ni/1400 rpm | CL6 Ni/1400 rpm | CL6 Ni/1400 rpm | CL6 Ni/1400 rpm |
| T max water inlet | 60°C | 60°C | 60°C | 60°C | 60°C |
| dimension (cm)/weight | 50x90x83/54 Kg (119 lbs) | 50x90x83/54 Kg (119 lbs) | 50x90x83/56 Kg (123 lbs) | 50x90x83/58 Kg (128 lbs) | 50x90x83/59 Kg (130 lbs) |

PLUS



New CL3.8 and CL 6.0 self-priming pumps with three pistons in integral ceramic, double oil viewer and brass head. New flanged pressure regulating valve L3.1, internal passages resized to ensure correct operation even in high operating flow conditions



Built-in elastic joint for better pump/ motor coupling







Sturdy protective steel cover to protect the motor pump against accidental impacts



Practical hose reel (optional) connected under pressure to use only the necessary length of hose and to rewind it easily after use

STANDARD EQUIPMENT

| | | | | |
|--|---|---|--|--|
|  <ul style="list-style-type: none"> • 00080-01695 Gun M22 - 3/8 with rotating coupling |  <ul style="list-style-type: none"> • 00080-01724 Lance M22 high/low pressure |  <ul style="list-style-type: none"> • 00080-03188 Nozzle type 045 (mod. 1211-2015) • 00080-03191 Nozzle type 060 (mod. 1515) • 00080-03193 Nozzle type 070 (mod. 2021) • 00080-03187 Nozzle type 040 (mod. 2515) |  <ul style="list-style-type: none"> • 00080-02347 High pressure hose 10 m | |
|--|---|---|--|--|

OPTIONAL

| | | | | |
|---|---|--|---|--|
| <ul style="list-style-type: none"> • 10001-10249 High-pressure hose reel (hose not included) | <ul style="list-style-type: none"> • 10001-10260 Foam System Device for dense foam production and spreading. | <ul style="list-style-type: none"> • High pressure hose code: 00080-02258 10 m - 310 bar 00080-02261 20 m - 400 bar 00080-02262 20 m - 400 bar 00080-02263 10 m - 400 bar food industry | <ul style="list-style-type: none"> • Turbo Lance code: 00080-02966 - (mod. 1211/2015/2515) 00080-02986 - (mod. 2021) 00080-02967 - (mod. 1515) | |
|---|---|--|---|--|

KCR



MORE INFO



CHARACTERISTICS

- 4 poles electrical motor (1400 rpm) with thermal protection and water cooling.
- Three ceramic pistons, Nickel plating brass linear pump head with high temperature water seals and bushing.
- Integrated elastic joint, for best pump coupling
- Low voltage and delayed Total Stop.
- Suction and delivery Stainless steel valves.
- Integrated detergent suction with external suction probe.
- Pressure regulator.
- Glycerine pressure gauge.
- Galvanized steel frame.
- Stainless Steel covers.

TECHNICAL DATA

| | KCR 2015 LP | KCR 2021 LP | KCR 2515 LP |
|------------------------|-----------------------------|-----------------------------|-----------------------------|
| code | 36092-00006 | 36092-00011 | 36092-00010 |
| rated/max pressure | 200/230 bar - 2900/3335 psi | 200/230 bar - 2900/3335 psi | 250/280 bar - 3600/4061 psi |
| max delivery flow rate | 900 l/h - 3.96 gpm | 1260 l/h - 5.55 gpm | 900 l/h - 3.96 gpm |
| abs. power/supply | 7000 W/400V-415 3~50Hz | 9400 W/400V-415 3~50Hz | 8500 W/400V 3~50Hz |
| motor power | 5,5 kW | 7,5 kW | 7,5 kW |
| pump model | CL6 Ni/1400 rpm | CL6 Ni/1400 rpm | CL6 Ni/1400 rpm |
| T max water inlet | 60°C | 60°C | 60°C |
| dimension (cm)/weight | 50x90x83/56 Kg (123 lbs) | 50x90x83/58 Kg (128 lbs) | 50x90x83/59 Kg (130 lbs) |

PLUS



New CL 6.0 self-priming pumps with three pistons in integral ceramic, double oil viewer and brass head. New flanged pressure regulating valve L3.1, internal passages resized to ensure correct operation even in high operating flow conditions



Integrated detergent tank with external probe for indirect suction of the chemical product





Painted steel handle adjustable via hinged joints, foldable to reduce dimensions and to improve portability



Sturdy stainless steel fairings for protection against accidental impacts

STANDARD EQUIPMENT

| | | | | |
|--|---|---|---|--|
|  <ul style="list-style-type: none"> • 00080-01695 Gun M22 - 3/8 with rotating coupling |  <ul style="list-style-type: none"> • 00080-01724 Lance M22 high/low pressure |  <ul style="list-style-type: none"> • 00080-03188 Nozzle type 045 (mod. 2015) • 00080-03193 Nozzle type 070 (mod. 2021) • 00080-03187 Nozzle type 040 (mod. 2515) |  <ul style="list-style-type: none"> • 00080-02347 High pressure hose 10 m | |
|--|---|---|---|--|

OPTIONAL

| | | | | |
|---|---|---|--|--|
| <ul style="list-style-type: none"> • 00080-01529 Kit hose reel with hose R2-5/16" 15 m. included for KCR 2015/2515 | <ul style="list-style-type: none"> • 00080-01524 Kit hose reel with hose R2-3/8" 15 m. included for KCR 2021 | <ul style="list-style-type: none"> • 00080-02966 Turbo Lance (2015/2515) | <ul style="list-style-type: none"> • 00080-02968 Turbo Lance (2021) | <ul style="list-style-type: none"> • 00080-02957 Sandblasting lance (2015/2515) |
| <ul style="list-style-type: none"> • 00080-02959 Sandblasting lance (2021) | | | | |

MCHP



Models: 1515 LP/2015 LP/2021 LP



Models: 1515 LP/2015 LP/2021 LP

MORE INFO



CHARACTERISTICS

- 4 poles electrical motor (1400 rpm) with thermal protection and water cooling.
- Three full ceramic pistons, brass linear pump head with built-in by-pass valve.
- Integrated elastic joint, for best pump coupling.
- Low voltage and delayed Total Stop.
- Suction and delivery Stainless steel valves.
- Detergent built-in tank for indirect suction.
- Pressure regulator. Glycerine pressure gauge.
- Pressure accumulator (only model 2021).
- Wall mount support (optional code 10001-10216).
- Galvanized steel frame.
- Plastic covers models MCHPV.

TECHNICAL DATA

| | MCHPV 1515 LP | MCHPV 2015 LP | MCHPV 2021 LP |
|------------------------|-----------------------------|-----------------------------|-----------------------------|
| code | 36077-00002 | 36077-00003 | 36077-00004 |
| rated/max pressure | 150/180 bar - 2175/2610 psi | 200/230 bar - 2900/3335 psi | 200/210 bar - 2900/3045 psi |
| max delivery flow rate | 900 l/h - 3.96 gpm | 900 l/h - 3.96 gpm | 1260 l/h - 5.55 gpm |
| abs. power/supply | 5000 W/400V 3~50Hz | 7000 W/400V 3~50Hz | 9400 W/400V 3~50Hz |
| motor power | 4,0 kW | 5,5 kW | 7,5 kW |
| pump model | CL6/1400 rpm | CL6/1400 rpm | CL6/1400 rpm |
| T max water inlet | 60°C | 60°C | 60°C |
| dimension (cm)/weight | 75x50x35/43 Kg (95 lbs) | 75x50x35/46 Kg (101 lbs) | 75x50x35/58 Kg (128 lbs) |

PLUS



Stacking module structure, it adapts perfectly to any type of installation



Built-in elastic joint for better pump/motor coupling



Wall Kits (optional) allows application to the wall for ease of use





Stainless steel versions for the food sector

Other available versions:

- 36077-00037** - MCHPX 1211 LP with stainless steel frame and fairings
- 36077-00038** - MCHPX 2015 LP with stainless steel frame and fairings



OPTIONAL

| | | | | |
|--|--|---|--|--|
| <ul style="list-style-type: none"> • 10001-10145 For food industry: 00080-01688 Gun + 00080-01717 S.S lance + 00080-02263 10mt Hose AP food + 00009-02100 Hose adapter + 00009-02101 Hose adapter /Gun  | | <ul style="list-style-type: none"> • 10001-10146 For industry: 00080-01695 Gun + 00080-01715 lance + 00080-02347 10mt Hose AP + 00009-02100 Hose adapter  | | |
| <ul style="list-style-type: none"> • 00080-03285 - Nozzle 060 (mod. 1515) • 00080-03283 - Nozzle 045 (mod. 2015) • 00080-03287 - Nozzle 075 (mod. 2021) | <ul style="list-style-type: none"> • 10001-10216 - Brackets for wall mounting | <ul style="list-style-type: none"> • High pressure hose code: 00080-02258 10 m - 310 bar 00080-02261 20 m - 400 bar 00080-02264 10 m R2 00080-02262 20 m - 400 bar 00080-02263 10 m - 400 bar food industry | <ul style="list-style-type: none"> • Turbo Lance code: 00080-02966 - (mod. 1211/2015) 00080-02986 - (mod. 2021) 00080-02967 - (mod. 1515) | <ul style="list-style-type: none"> • Sand-blasting lance code: 00080-02957 (mod. 1211/2015) 00080-02958 (mod. 2021) |

Indo E



MORE INFO



CHARACTERISTICS

- 4 poles electrical motor 12-15 hp with thermal protection
- **Motor-pump with flexible joint**
- Heavy duty structure with stainless steel covers
- High filtering capacity cartridge suction brass filter
- RW Triplex Premium pumps
- Pressure gauge with stainless steel casing
- **Hot water seals 4-poles (1400 rpm)** motor well oversized and protected with paint. Ø 300 wheels with brake
- Highly professional unloader valve with external bypass
- Timed Total Stop
- Low voltage control panel
- Contactor
- Thermal relay motor protection
- Hose reel with 20 m hose can be mounted on request (mod. 2521/3518)
- Practical and safe housing accessories

On request 60Hz version

TECHNICAL DATA

| | Indo 2521 E LP | Indo 3518 E LP | Indo 2030 E LP |
|------------------------|------------------------------|------------------------------|------------------------------|
| code | 36019-00062 | 36019-00063 | 36019-00066 |
| rated/max pressure | 250/260 bar - 3626/3770 psi | 350/360 bar - 5076/5221 psi | 200/220 bar - 2900/3190 psi |
| max delivery flow rate | 1290 l/h - 5.6 gpm | 1110 l/h - 4.8 gpm | 1860 l/h - 8.1 gpm |
| abs. power/supply | 10000 W/400V 3~50Hz | 11500 W/400V 3~50Hz | 11500 W/400V 3~50Hz |
| motor power | 7,5 kW | 9,2 kW | 11 kW |
| pump model | RW/1400 rpm | TW/1400 rpm | TW/1400 rpm |
| T max water inlet | 85°C | 85°C | 85°C |
| dimension (cm)/weight | 126x74x98/125 Kg (275,5 lbs) | 126x74x98/130 Kg (286,5 lbs) | 126x74x98/130 Kg (286,5 lbs) |

PLUS



Widely oversized 4-pole industrial electric motor, protected from painting and equipped with elastic joint for better motor/pump coupling



RW/TW Premium self-priming three-piston pumps in integral ceramic, tapered roller bearings, double oil viewer and brass head







Sturdy painted steel frame with vertical lifting bar, practical side hooks for accessories and protective stainless steel covers to preserve the motor pump from accidental impacts



Automatic regulation valve with external by-pass and gradual pressure reset (Indo 3518)

STANDARD EQUIPMENT

| | | | | |
|---|---|--|--|--|
|  <ul style="list-style-type: none"> • 00080-01097 Gun ML 955 - M22 with quick coupling (mod. 2521-2030) • 00080-01098 Gun ML 955 - M24 with quick coupling (mod. 3518) |  <ul style="list-style-type: none"> • 10002-04019 lance SF40 mecline M22 (mod.2521-2030) • 10002-04020 lance SF40 mecline M24 (mod.3518) |  <ul style="list-style-type: none"> • 00080-01368 Nozzle type 040 (mod. 3518) • 00080-00359 Nozzle type 055 (mod. 2521) • 00080-03339 Nozzle type 2510 (mod. 2030) |  <ul style="list-style-type: none"> • 10002-04109 High pressure hose 10 m (mod.2521/2030) • 10002-04110 High pressure hose 10 m (mod.3518) | |
|---|---|--|--|--|

OPTIONAL

| | | | | |
|---|--|--|---|--|
| <ul style="list-style-type: none"> • Turbo lance code: 10002-04103 (mod. 2521) 10002-04104 (mod. 3518) • for model 2030: on request | <ul style="list-style-type: none"> • Pipe cleaning hose 25 m code: 00058-02983 (mod. 2521) 00058-00650 (mod.3518) • for model 2030: on request | <ul style="list-style-type: none"> • Extension hose 10 m code: 10002-04105 (mod. 2521/2030) 10002-04106 (mod. 3518) | <ul style="list-style-type: none"> • Sand-blasting lance 500 bar code: 10002-04107 (mod.2521/2030) 10002-04108 (mod. 3518) | |
|---|--|--|---|--|

Lena E



MORE INFO



CHARACTERISTICS

- Sturdy frame painted with anti-corrosive treatment • Stainless steel cover panels • **Low voltage (24V) control panel with start-delta system** • Handy lance and gun storage • High filtering capacity cartridge suction filter • Ø 300 industrial wheels with brake • Electric motor (1400 rpm) 20,25 and 30 hp • TW 500 Premium pumps /TW • Motor-pump coupling by means of a flexible joint • Automatic unloader valve with external bypass and gradual pressure restoring (on 5018 and 5021 models) • Overheating thermostatic valve • Low voltage (24V) start-up panel (star-delta) • Remote switch and motor cut-out with thermal relay • Emergency stop button • **Hour counter** • Hose reel with 20 mt hose can be mounted on request (cod. 00080-01521)

On request 60Hz version

TECHNICAL DATA

| | Lena 5015 E LP | Lena 5018 E LP | Lena 5021 E LP | Lena 2042 E LP |
|------------------------|-------------------------------|-------------------------------|-------------------------------|-------------------------------|
| code | 36019-00068 | 36019-00069 | 36019-00070 | 36019-00074 |
| rated/max pressure | 500/520 bar - 7252/7541 psi | 500/520 bar - 7252/7541 psi | 500/520 bar - 7252/7541 psi | 200/215 bar - 2900/3118 psi |
| max delivery flow rate | 990 l/h - 4.3 gpm | 1110 l/h - 4.8 gpm | 1260 l/h - 5.55 gpm | 2520 l/h - 11.09 gpm |
| abs. power/supply | 15000 W/380-415V 3~50Hz | 19000 W/380-415V 3~50Hz | 23000 W/380-415V 3~50Hz | 18500 W/380-415V 3~50Hz |
| motor power | 15 kW | 18,5 kW | 22 kW | 18,5 kW |
| pump model | TW500/1400 rpm | TW500/1400 rpm | TW500/1400 rpm | TW/1400 rpm |
| T max water inlet | 60°C | 60°C | 60°C | 60°C |
| dimension (cm)/weight | 118,5x74x100/215 Kg (473 lbs) | 118,5x74x100/260 Kg (496 lbs) | 118,5x74x100/285 Kg (507 lbs) | 118,5x74x100/225 Kg (496 lbs) |

PLUS



Widely oversized 4-pole industrial electric motor, protected from painting and equipped with elastic joint for better motor/pump coupling



TW Premium 500 self-priming three-piston pumps in integral ceramic, tapered roller bearings, double oil viewer and brass head







Sturdy painted steel frame with vertical lifting bar, practical side hooks for accessories and protective stainless steel covers to preserve the motor pump from accidental impacts



Automatic adjustment valve with external by-pass and gradual pressure reset (Lena 5021)

STANDARD EQUIPMENT

| | | | | |
|---|--|---|---|--|
|  <ul style="list-style-type: none"> • 00080-01099 Gun ML 960 with quick coupling M24-M24 (mod.5015/5018) | <ul style="list-style-type: none"> • 00080-03947 Gun ML955 M24 (mod. 2042) |  <ul style="list-style-type: none"> • 00080-01100 Gun ML 710 with quick coupling M24-M24 (mod.5021) |  <ul style="list-style-type: none"> • 10002-04021 Stainless steel Lance 500 bar L50 (mod.5015/5018/2042) |  <ul style="list-style-type: none"> • 10002-04022 Stainless steel Lance 500 bar L70 (mod.5021) |
|  <ul style="list-style-type: none"> • 00080-00355 Nozzle type 028 (mod. 5015) • 00080-00350 Nozzle type 035 (mod. 5018) • 00080-00317 Nozzle type 040 (mod. 5021) • 00080-03340 Nozzle type 12 (mod. 2042) | <ul style="list-style-type: none"> • 10002-04111 High pressure hose 10 m • 10002-04110 High pressure hose 10 m (mod. 2042) | <ul style="list-style-type: none"> • 00009-02403 Rotating coupling G3/8M - M24 AISI303 | | |

OPTIONAL

| | | | | |
|---|--|--|--|---|
| <ul style="list-style-type: none"> • Turbo lance code: 10002-04094 (mod. 5015) 10002-04095 (mod. 5018) 10002-04096 (mod. 5021) • for model 2042: on request | <ul style="list-style-type: none"> • Pipe cleaning hose 25 m code: 00058-00648 (mod. 5015) 00058-00649 (mod. 5018/5021) • for model 2042: on request | <ul style="list-style-type: none"> • Extension hose 20 m. 10002-04098 | <ul style="list-style-type: none"> • Sand-blasting lance 500 bar code: 10002-04100 (mod. 5015) 10002-04101 (mod. 5018/5021) • for model 2042: on request | <ul style="list-style-type: none"> • 00069-00223 Apron |
|---|--|--|--|---|

Irtys E

**PRESSURE
700 bar**



MORE INFO



CHARACTERISTICS

- Sturdy frame painted with anti-corrosive treatment • Stainless steel cover panels • Handy lance and gun storage • High filtering capacity cartridge suction filter • Pneumatic wheels with steel hub and air chamber • Electric motor (1400 rpm) 30 hp • TW 700 triplex pump • Motor-pump coupling with flexible joint • Stainless steel pressure gauge • Automatic unloader valve with external bypass and gradual pressure relief • Safety valve • Overheating thermostatic valve • Low voltage (24V) start-up panel (star-delta) • Remote switch and motor cut-out with thermal relay • Emergency stop button • **Hour counter**

TECHNICAL DATA

| | Irtys E LP |
|------------------------|-------------------------------|
| code | 36019-00084 |
| rated/max pressure | 700/770 bar - 10152/11167 psi |
| max delivery flow rate | 900 l/h - 3.96 gpm |
| abs. power/supply | 22000 W/380-415V 3~50Hz |
| motor power | 22 kW |
| pump model | TW700/1400 rpm |
| T max water inlet | 60°C |
| dimension (cm)/weight | 100x75x85/230 Kg (507 lbs) |

PLUS



Widely oversized 4-pole industrial electric motor, protected from painting and equipped with elastic joint for better motor/pump coupling



TW Premium 700 pump with nickel-plated brass head and ceramic pistons



Sturdy painted steel frame with vertical lifting bar, practical side hooks for accessories and protective stainless steel covers to preserve the motor pump from accidental impacts



Standard 1000 bar accessories , oversized to ensure the highest level of safety for the operator

STANDARD EQUIPMENT

| | | | | |
|---|---|---|--|--|
|  <ul style="list-style-type: none"> • 00080-04562 Gun RL1100 with lance |  <ul style="list-style-type: none"> • 00080-04553 Nozzle type 020 700 bar |  <ul style="list-style-type: none"> • 00042-00243 Safety sock for gun | <ul style="list-style-type: none"> • 00070-00710 Self-cleaning filter 1" |  <ul style="list-style-type: none"> • 00014-00520 High pressure hose with safety sock 20 m |
|---|---|---|--|--|

OPTIONAL

| | | | | |
|--|---|---|--|--|
| <ul style="list-style-type: none"> • 00080-04623 Turbo nozzle | <ul style="list-style-type: none"> • 00080-01225 Sand blasting lance |  <ul style="list-style-type: none"> • 00069-00250 Helmet kit + apron + hand protections + gaiters | | |
|--|---|---|--|--|

Thermic 5H



MORE INFO



CHARACTERISTICS

- Three ceramic coated pistons, brass axial pump head with built-in by-pass valve.
- Suction and delivery Stainless steel valves. 5 hp **Honda** GP 160 unleaded gasoline engine.
- Manual start
- Integrated detergent suction with external suction probe.
- Pressure regulator.
- Glycerine pressure gauge.
- Hose reel **(optional)**.
- Suction hose with check valve **(optional)**.
- Steel frame.
- Hose holder.
- 3,1 l gasoline tank.

TECHNICAL DATA

| | Thermic 5H |
|------------------------|-----------------------------|
| code | 36113-00053 |
| rated/max pressure | 160/190 bar - 2320/2755 psi |
| max delivery flow rate | 570 l/h - 2.51 gpm |
| engine type | Honda GP 160 |
| motor power | 5 hp |
| pump model | TPBH4/3400 rpm |
| T max water inlet | 40°C |
| dimension (cm)/weight | 70x59x97/37 Kg (81 lbs) |

PLUS



Linear self-priming pump with three ceramic pistons and brass head



Sturdy painted steel frame with rear wheels and anti-vibration front foot for stable positioning, handle with ergonomic handle for easy movement on any type of surface



Side support for lance and gun housing



Pneumatic wheels to dampen vibrations and to promote movement on any type of surface

STANDARD EQUIPMENT

| | | | | |
|--|---|---|--|--|
|  <ul style="list-style-type: none"> • 00080-01701 Gun M22 - 3/8. |  <ul style="list-style-type: none"> • 00080-01724 Lance M22 high/low pressure |  <ul style="list-style-type: none"> • 00080-03186 Nozzle type 035 |  <ul style="list-style-type: none"> • 00080-02254 High pressure hose 8 m | |
|--|---|---|--|--|

OPTIONAL

| | | | | |
|---|---|--|--|--|
| <ul style="list-style-type: none"> • 10001-10200 High-pressure hose reel (hose not included) |  <ul style="list-style-type: none"> • 10002-12275 Suction hose with check valve | <ul style="list-style-type: none"> • 00080-02254 8 m High pressure hose - 3/8" M22 - Ø 1/4" - 210 bar | <ul style="list-style-type: none"> • 00080-02261 20 m High pressure hose - 3/8" - Ø 5/16" - 400 bar | <ul style="list-style-type: none"> • 00080-02957 Sandblasting lance |
|---|---|--|--|--|

Thermic 2W Lite 6L



MORE INFO



CHARACTERISTICS

- Loncin G200F gasoline engine • Axial pump with three stainless steel pistons, brass head and integrated regulating valve with double seal • Low pressure detergent suction • Easily inspectable suction water filter • Thermostatic valve for overtemperature • Ø 260 pneumatic wheels • Heavy semi-professional use • Inflated wheels (air chamber)

TECHNICAL DATA

| | Thermic 2W lite 6L |
|------------------------|-----------------------------|
| code | 36001-00053 |
| rated/max pressure | 200/220 bar - 2900/3190 psi |
| max delivery flow rate | 630 l/h - 2.7 gpm |
| engine type | Loncin G200F |
| motor power | 6,5 hp |
| pump model | TPBH2/3400 rpm |
| T max water inlet | 40°C |
| dimension (cm)/weight | 55x67x80/28 Kg (61,7 lbs) |

PLUS



Axial pump with stainless steel pistons, brass head, double water seal



Sturdy painted steel frame with rear inner tube wheels and front anti-vibration foot for stable positioning, handle with ergonomic handle for easy movement on any type of surface

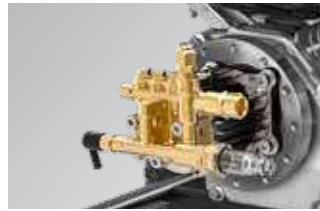

Pressure regulating valve to vary the power of the water jet according to actual requirements

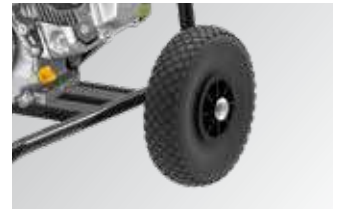

Painted steel handle with hose holder, removable during transportation

STANDARD EQUIPMENT

| | | | | |
|---|---|---|--|--|
|  <ul style="list-style-type: none"> • 00080-01137 Gun M22 |  <ul style="list-style-type: none"> • 10002-03541 Lance M22 high/low pressure |  <ul style="list-style-type: none"> • 10002-04760 Turbo lance |  <ul style="list-style-type: none"> • 00080-00350 Ceramic nozzle 15° 035 |  <ul style="list-style-type: none"> • 36001-00053 High pressure hose R1 10 m |
|---|---|---|--|--|

Thermic 6,5



CHARACTERISTICS

- Three ceramic coated pistons, brass linear pump head with built-in by-pass valve. • Suction and delivery stainless steel valves. • Manual start • 6.5 hp unleaded gasoline engine. • Integrated detergent suction with external suction probe. • Glycerine pressure gauge. • Hose-reel (**optional**). • Suction hose with check valve (**optional**). • Steel frame. • Hose holder. • Nozzles holder. • 3,1 l gasoline tank.

TECHNICAL DATA

| | Thermic 6,5 |
|------------------------|-----------------------------|
| code | 36113-00027 |
| rated/max pressure | 180/210 bar - 2610/3045 psi |
| max delivery flow rate | 690 l/h - 2.77 gpm |
| engine type | Lifan |
| motor power | 6,5 hp |
| pump model | MP4/3400 rpm |
| T max water inlet | 40°C |
| dimension (cm)/weight | 47x57x57/38,5 Kg (84,9 lbs) |

PLUS



Linear self-priming pump with three ceramic pistons and brass head



Sturdy painted steel frame with rear wheels and anti-vibration front foot for stable positioning, handle with ergonomic handle for easy movement on any type of surface







Side support for lance and gun housing



Pneumatic wheels to dampen vibrations and to promote movement on any type of surface

STANDARD EQUIPMENT

| | | | | |
|--|---|--|---|---|
|  <ul style="list-style-type: none"> • 00080-02517 Gun M22 - 1/4" |  <ul style="list-style-type: none"> • 00080-02770 Lance M22 with nozzle-holder. |  <ul style="list-style-type: none"> • 10002-12432 High pressure nozzle set |  <ul style="list-style-type: none"> • 00080-02367 High pressure hose 10 m |  <ul style="list-style-type: none"> • 00014-01565 Garden hose 2,5 m |
|--|---|--|---|---|

OPTIONAL

| | | | | |
|---|---|--|--|--|
| <ul style="list-style-type: none"> • 10001-10200 High-pressure hose reel (hose not included) |  <ul style="list-style-type: none"> • 10002-12275 Suction hose with check valve | <ul style="list-style-type: none"> • 00080-02264 10 m High pressure hose - 3/8" - Ø 3/8" R2 | <ul style="list-style-type: none"> • 00080-02261 20 m High pressure hose - 3/8" - Ø 5/16" - 400 bar | |
|---|---|--|--|--|

Thermic 9 L



MORE INFO



CHARACTERISTICS

- Three ceramic coated pistons, brass linear pump head with built-in by-pass valve • Suction and delivery stainless steel valves • Manual start • 9 hp unleaded gasoline engine. • By-pass with safety valve. • Integrated detergent suction with external suction probe. • Pressure regulator. • Suction hose with check valve **(optional)**. • Hose holder. • Nozzles holder. • 4 l gasoline tank.

TECHNICAL DATA

| | Thermic 9 L |
|------------------------|-----------------------------|
| code | 36113-00033 |
| rated/max pressure | 220/250 bar - 3190/3625 psi |
| max delivery flow rate | 900 l/h - 3.96 gpm |
| engine type | Loncin |
| motor power | 9 hp |
| pump model | TPBH5/3400 rpm |
| T max water inlet | 40°C |
| dimension (cm)/weight | 50x67x103/45 Kg (101 lbs) |

PLUS



Linear self-priming pump with three ceramic pistons and brass head



Sturdy painted steel frame with rear wheels and anti-vibration front foot for stable positioning, handle with ergonomic handle for easy movement on any type of surface







Side support for lance and gun housing and nozzle holder base



Pneumatic wheels to dampen vibrations and to promote movement on any type of surface

STANDARD EQUIPMENT

| | | | | |
|--|---|--|---|--|
|  <ul style="list-style-type: none"> • 00080-01701 Gun M22 - 3/8" |  <ul style="list-style-type: none"> • 00080-02770 Lance M22 with nozzle-holder. |  <ul style="list-style-type: none"> • 10002-12241 High pressure nozzle set |  <ul style="list-style-type: none"> • 00080-02258 High pressure hose 10 m | |
|--|---|--|---|--|

OPTIONAL

| | | | | |
|---|--|---|--|--|
|  <ul style="list-style-type: none"> • 10002-12275 Suction hose with check valve | <ul style="list-style-type: none"> • High pressure hose code: 00080-02258 10 m - 310 bar 00080-02261 20 m - 400 bar 00080-02264 10 m R2 | <ul style="list-style-type: none"> • 00080-02966 Lance Turbo type 1 M22 - 0,45 | <ul style="list-style-type: none"> • 00080-02957 Sandblasting lance | |
|---|--|---|--|--|

Thermic 2W

POWERED by
HONDA™
 only model 9H/13 H



MORE INFO



CHARACTERISTICS

- Honda GX and Loncin gasoline engines • Heavy duty pump, 3 ceramic pistons, brass pump head and built-in unloader valve • Unleaded gasoline engine 9 hp **Honda GX 270** (Thermic 2W 9 H) • Unleaded gasoline engine 13 hp **Loncin G 390F** (Thermic 2W 13 L) • Unleaded gasoline engine 13 hp **Honda GX 390** (Thermic 2W 13 H) • 5 litres detergent tank with filter and cap • Readily serviceable suction water filter • Oil-alert safety device for engine protection • Glycerine pressure gauge. • Ø 300 big pneumatic wheels; easy to handle also up and down steps and over uneven ground • stainless steel pump cover on request • Thermostatic valve

TECHNICAL DATA

| | Thermic 2W 9 H | Thermic 2W 13 L | Thermic 2W 13 H |
|------------------------|-----------------------------|-----------------------------|-----------------------------|
| code | 36021-00034 | 36021-00036 | 36021-00035 |
| rated/max pressure | 210/220 bar - 3045/3190 psi | 290/310 bar - 4206/4496 psi | 290/310 bar - 4206/4496 psi |
| max delivery flow rate | 900 l/h - 3.96 gpm | 900 l/h - 3.96 gpm | 900 l/h - 3.96 gpm |
| engine type | Honda GX 270 | Loncin G 390F | Honda GX 390 |
| motor power | 9 hp | 13 hp | 13 hp |
| pump model | CL 4.5/3400 rpm | CL 4.5/3400 rpm | CL 4.5/3400 rpm |
| T max water inlet | 60°C | 60°C | 60°C |
| dimension (cm)/weight | 85x58x105/48 Kg (105 lbs) | 85x58x105/51 Kg (112 lbs) | 85x58x105/51 Kg (112 lbs) |

PLUS



Ergonomic handle in painted steel adjustable by means of hinged joints, foldable to reduce dimensions and to improve portability



Sturdy tubular frame in painted steel with anti-vibration front feet for stability, inflatable rear wheels with a diameter of 300 mm to facilitate movement on any type of surface.







Integrated detergent tank with external probe for indirect suction of the chemical product



Sturdy stainless steel fairing for protection against accidental impacts

STANDARD EQUIPMENT

| | | | | |
|---|---|---|---|--|
|  <ul style="list-style-type: none"> • 00080-01040 Gun M22 - 3/8 with rotating coupling. |  <ul style="list-style-type: none"> • 10002-04732 Lance M22 high/low pressure |  <ul style="list-style-type: none"> • 00080-03330 Nozzle type (Thermic 2W 9 H) • 00080-03329 Nozzle type (Thermic 2W 13 L) (Thermic 2W 13 H) |  <ul style="list-style-type: none"> • 10002-03986 High pressure hose 10 m | |
|---|---|---|---|--|

OPTIONAL

| | | | | |
|---|--|---|---|---|
| <ul style="list-style-type: none"> • Hose reel kit cod. 00080-01538 hose included (15 m) | <ul style="list-style-type: none"> • 10002-04737 Turbo lance (Thermic 2W 9 H) | <ul style="list-style-type: none"> • 10002-03704 Turbo lance (Thermic 2W 13 L) (Thermic 2W 13 H) | <ul style="list-style-type: none"> • 10002-12275 Suction hose with check valve | <ul style="list-style-type: none"> • 00080-02258 Extension hose 10 m |
| <ul style="list-style-type: none"> • 00014-00233 Extension hose R2 20 m + 00009-01792 Coupling | | | | |

Thermic 2W Lite 13L



MORE INFO



CHARACTERISTICS

- Loncin G390F gasoline engine • Axial pump with 3 ceramic pistons, brass head and integrated regulating valve • Low pressure detergent suction • Easily inspectable suction water filter • Oil-Alert safety device (lack of oil) for motor protection • Pressure gauge • Thermostatic valve for overtemperature • Ø 260 pneumatic wheels • Heavy semi-professional use

TECHNICAL DATA

| | Thermic 2W lite 13L |
|------------------------|-----------------------------|
| code | 36001-00052 |
| rated/max pressure | 290/310 bar - 4206/4496 psi |
| max delivery flow rate | 900 l/h - 3.9 gpm |
| engine type | Loncin G390F |
| motor power | 13 hp |
| pump model | CL4.5/3400 rpm |
| T max water inlet | 60°C |
| dimension (cm)/weight | 55x67x89/35 Kg (77 lbs) |

PLUS



Linear pump with three ceramic pistons, brass head and regulating valve



Pneumatic wheels to dampen vibrations and to promote movement on any type of surface







Pressure regulating valve to vary the power of the water jet according to actual requirements



Painted steel handle with hose holder, removable during transportation

STANDARD EQUIPMENT

| | | | | |
|---|---|--|--|--|
|  <ul style="list-style-type: none"> • 00080-01695 Gun M22 |  <ul style="list-style-type: none"> • 10002-04732 Lance M22 high/low pressure |  <ul style="list-style-type: none"> • 10002-03703 Lancia Turbo 350 bar |  <ul style="list-style-type: none"> • 00080-00350 Ceramic nozzle 15° 035 |  <ul style="list-style-type: none"> • 00014-00514 High pressure hose R2 10 m |
|---|---|--|--|--|

Thermic 10.1 D



MORE INFO



CHARACTERISTICS

- Three ceramic pistons, brass linear pump head with by-pass valve. • Gear box between engine and pump (1560 rpm) • By-pass with thermostatic valve. • Automatic rpm regulation. • Electrical start with engine functions control. • Yanmar L100V Diesel engine (air cooled) with integrated Diesel tank. • Integrated regolable detergent suction with external suction probe. • Pressure regulator. • Glycerine pressure gauge. • Suction hose with check valve (**optional**). • Heavy duty steel frame. • Battery included. • Brass filter. • Pneumatic effect Ø 260 wheels with brake

TECHNICAL DATA

| | Thermic 10.1 D 1621 | Thermic 10.1 D 2016 |
|------------------------|-----------------------------|-----------------------------|
| code | 36022-00030 | 36022-00029 |
| rated/max pressure | 160/180 bar - 2320/2610 psi | 200/230 bar - 2900/3335 psi |
| max delivery flow rate | 1260 l/h - 5.5 gpm | 960 l/h - 4.2 gpm |
| engine type | Yanmar L100V | Yanmar L100V |
| motor power | 9,3 hp | 9,3 hp |
| pump model | CL6.0/1560 rpm | CL6.0/1560 rpm |
| T max water inlet | 60°C | 60°C |
| dimension (cm)/weight | 95x68x95/124 Kg (231 lbs) | 95x68x95/124 Kg (231 lbs) |

PLUS



New CL 6.0 self-priming pump with three pistons in integral ceramic, double oil viewer and brass head. Speed reducer between motor and pump. New flanged pressure regulating valve L3.1, internal passages resized to ensure correct operation even in high operating flow conditions



4 twin pneumatic wheels to dampen vibrations and to promote movement on any type of surface, parking brake







Yanmar L100V diesel engine, electric start panel with control lights, automatic rev decelerator



Sturdy painted steel tubular frame, vertical lifting hook, removable handle during transportation, with accessory holder hook

STANDARD EQUIPMENT

| | | | | |
|---|---|--|---|--|
|  <ul style="list-style-type: none"> • 00080-01695 Gun M22 |  <ul style="list-style-type: none"> • 10002-04732 Lance M22 high/low pressure |  <ul style="list-style-type: none"> • 00080-03341 Nozzle 075 (mod. 1621) • 00080-03247 Nozzle 050 (mod. 2016) |  <ul style="list-style-type: none"> • 00014-00514 High pressure hose R2 10 m (mod. 2016) • 10002-04109 High pressure hose R2 10 m (mod.1621) | |
|---|---|--|---|--|

OPTIONAL

| | | | | |
|---|--|--|---|---|
|  <ul style="list-style-type: none"> • 10002-12275 Suction hose with check valve | <ul style="list-style-type: none"> • 10002-04739 Turbo lance 255 bar 050 (mod.2016) | <ul style="list-style-type: none"> • 10002-04741 Turbo lance 255 bar 070 (mod.1621) | <ul style="list-style-type: none"> • 00080-02958 Sand blasting lance | <ul style="list-style-type: none"> • 00080-01527 Kit hose reel with 15m R2 3/8" hose |
|---|--|--|---|---|

Thermic 2W PRO

POWERED by
HONDA™
 Only Thermic 2W PRO 13 H



MORE INFO



CHARACTERISTICS

- Gearbox reducer between engine and pump (1560 rpm) • Self-priming CL6.0 Lavor pump, 3 ceramic pistons, brass pump head and unloader valve flanged • Suction and delivery Stainless steel valves. • Unleaded gasoline engine 13 hp **Honda** GX 390 (Thermic 2W PRO 13 H) • Unleaded gasoline engine 13 hp **Loncin** G 390F (Thermic 2W PRO 13 L) • 5 litres detergent tank with filter and cap • Readily serviceable suction water filter • Oil-alert safety device for engine protection • Glycerine pressure gauge. • Folding handle with aluminium hinges • Ø 300 big pneumatic wheels; easy to handle also up and down steps and over uneven ground • Stainless steel pump cover on request

TECHNICAL DATA

| | Thermic 2W PRO 13 L | Thermic 2W PRO 13 H |
|------------------------|-----------------------------|-----------------------------|
| code | 36021-00038 | 36021-00037 |
| rated/max pressure | 250/260 bar - 3625/3770 psi | 250/260 bar - 3625/3770 psi |
| max delivery flow rate | 1020 l/h - 4.4 gpm | 1020 l/h - 4.4 gpm |
| engine type | Loncin G 390F | Honda GX 390 |
| motor power | 13 hp | 13 hp |
| pump model | CL6.0/1560 rpm | CL6.0/1560 rpm |
| T max water inlet | 60°C | 60°C |
| dimension (cm)/weight | 85x58x105/65 Kg (143 lbs) | 85x58x105/65 Kg (143 lbs) |

PLUS



New CL 6.0 self-priming pump with three pistons in integral ceramic, double oil viewer and brass head. Speed reducer between motor and pump. New flanged pressure regulating valve L3.1, internal passages resized to ensure correct operation even in high operating flow conditions



Ergonomic handle in painted steel adjustable by means of hinged joints, foldable to reduce dimensions and to improve portability







Robust tubular frame in painted steel with anti-vibration front feet for stability, inflatable rear wheels with a diameter of 300 mm to facilitate movement on any type of surface, stainless steel fairing.



Integrated detergent tank with external probe for indirect suction of the chemical product

STANDARD EQUIPMENT

| | | | | |
|---|---|---|---|--|
|  <ul style="list-style-type: none"> • 00080-01695 Gun M22 - 3/8 with rotating coupling. |  <ul style="list-style-type: none"> • 00080-01739 Lance M22 high/low pressure |  <ul style="list-style-type: none"> • 00080-03329 Inox 350 bar nozzle type 037 inox |  <ul style="list-style-type: none"> • 00014-00514 High pressure hose 10 m | |
|---|---|---|---|--|

OPTIONAL

| | | | | |
|---|---|---|---|---|
|  <ul style="list-style-type: none"> • 10002-12275 Suction hose with check valve | <ul style="list-style-type: none"> • Hose reel kit cod. 00080-01524 hose included (15 m) | <ul style="list-style-type: none"> • 10002-03408 Turbo lance 255 bar | <ul style="list-style-type: none"> • 00080-02258 Extension hose 10 m | <ul style="list-style-type: none"> • 00080-02262 Extension hose 20 m |
|---|---|---|---|---|

Thermic 13 H

POWERED by
HONDA™



MORE INFO



CHARACTERISTICS

- Three ceramic pistons, brass linear pump head. • Gearbox reducer between engine and pump (1560 rpm) • Automatic rpm regulation.
- By-pass with safety valve. • Suction and delivery Stainless steel valves. • Unleaded gasoline engine 13 hp **Honda GX 390**. • Integrated detergent suction with external suction probe. • Glycerine pressure gauge. • Heavy duty steel frame. • 6,5 l gasoline tank. • Suction hose with check valve (**optional** cod. 10002-12275).

TECHNICAL DATA

| | Thermic 13 H |
|------------------------|-----------------------------|
| code | 36113-00013 |
| rated/max pressure | 250/280 bar - 3625/4061 psi |
| max delivery flow rate | 1080 l/h - 4.76 gpm |
| engine type | Honda GX 390 |
| motor power | 13 hp |
| pump model | CL5/1560 rpm |
| T max water inlet | 60°C |
| dimension (cm)/weight | 100x66x92/61 Kg (134 lbs) |

PLUS



Honda GX 390 – 13hp petrol engine with automatic decelerator



New CL 6.0 self-priming pump with three pistons in integral ceramic, double oil viewer and brass head. Speed reducer between motor and pump. New flanged pressure regulating valve L3.1, internal passages resized to ensure correct operation even in high operating flow conditions





Sturdy painted steel frame with side support for lance and gun housing



4 twin wheels for stable positioning and ease of movement

STANDARD EQUIPMENT

| | | | | |
|--|---|---|---|--|
|  <ul style="list-style-type: none"> • 00080-01695 Gun M22 - 3/8 with rotating coupling |  <ul style="list-style-type: none"> • 00080-01724 Lance M22 high/low pressure |  <ul style="list-style-type: none"> • 00080-03189 Nozzle type 050 |  <ul style="list-style-type: none"> • 00080-02347 High pressure hose 10 m | |
|--|---|---|---|--|

OPTIONAL

| | | | | |
|---|---|--|---|---|
| <ul style="list-style-type: none"> • Protective frame with lifting hooking (optional cod. 00071-03396) |  <ul style="list-style-type: none"> • Hose reel optional cod. 10001-10245 (hose not included) in combination with protective frame. | <ul style="list-style-type: none"> • High pressure hose code: 00080-02258 10 m - 310 bar 00080-02261 20 m - 400 bar 00080-02262 20 m - 400 bar 00080-02263 10 m - 400 bar food industry | <ul style="list-style-type: none"> • 00080-02966 Lance Turbo type 1 M22 - 0,45 | <ul style="list-style-type: none"> • 00080-02958 Sand blasting lance |
|---|---|--|---|---|

Thermic 13 HF

POWERED by
HONDA™



MORE INFO



CHARACTERISTICS

- Three ceramic pistons, brass linear pump head. • 1560 rpm reducer between engine and pump. • Automatic rpm regulation. • By-pass with safety valve. • Suction and delivery Stainless steel valves. • Unleaded gasoline engine 13 hp **Honda** GX 390. • Integrated detergent suction with external suction probe. • Pressure regulator. • Glycerine pressure gauge. • Heavy duty steel frame. • 6,5 l gasoline tank. • Suction hose with check valve (**optional** cod. 10002-12275).

TECHNICAL DATA

| | Thermic 13 HF |
|------------------------|-----------------------------|
| code | 36113-00035 |
| rated/max pressure | 250/280 bar - 3625/4061 psi |
| max delivery flow rate | 1080 l/h - 4.76 gpm |
| engine type | Honda GX 390 |
| motor power | 13 hp |
| pump model | CL5/1560 rpm |
| T max water inlet | 60°C |
| dimension (cm)/weight | 100x66x92/65 Kg (143 lbs) |

PLUS



Honda GX 390 – 13hp petrol engine with automatic decelerator



New CL 6.0 self-priming pump with three pistons in integral ceramic, double oil viewer and brass head. Speed reducer between motor and pump. New flanged pressure regulating valve L3.1, internal passages resized to ensure correct operation even in high operating flow conditions



Robust tubular frame in painted steel with side support for lance and gun housing



4 twin wheels for stable positioning and ease of movement

STANDARD EQUIPMENT

| | | | | |
|--|---|---|---|---|
|  <ul style="list-style-type: none"> • 00080-01695 Gun M22 - 3/8 with rotating coupling |  <ul style="list-style-type: none"> • 00080-01724 Lance M22 high/low pressure |  <ul style="list-style-type: none"> • 00080-02966 Turbo lance M22 |  <ul style="list-style-type: none"> • 00080-03189 Nozzle type 050 • 00080-04626 Rotating nozzle type 045 |  <ul style="list-style-type: none"> • 00080-02347 High pressure hose 10 m |
|--|---|---|---|---|

OPTIONAL

| | | | |
|---|--|---|---|
|  <ul style="list-style-type: none"> • Hose reel optional cod. 10001-10245 (hose not included) in combination with protective frame. | <ul style="list-style-type: none"> • High pressure hose code: 00080-02258 10 m - 310 bar 00080-02261 20 m - 400 bar 00080-02262 20 m - 400 bar 00080-02263 10 m - 400 bar food industry | <ul style="list-style-type: none"> • 00080-02966 Lance Turbo type 1 M22 - 0,45 | <ul style="list-style-type: none"> • 00080-02958 Sand blasting lance |
|---|--|---|---|

Thermic 18 BS/22 H

POWERED by
HONDATM
Only Thermic 22 H



MORE INFO



18BS

MORE INFO



22H

CHARACTERISTICS

- TW Premium/TW 500 bar Premium pumps with brass pump head and ceramic pistons
- Briggs & Stratton Vanguard (Thermic 18 BS)/Honda engine GX 690 (Thermic 22 H)
- Gearbox (with 1560 rpm pump)
- Electrical starting
- Ø 300 industrial wheels with brake
- No engine-oil safety device (oil-alert)
- **Hour counter**
- Automatic decelerator to reduce the number of revs in the bypass phase
- Stainless steel gradual pressure restoration valve with EASY-START
- Thermostatic valve
- Water filter, readily serviceable cartridge type
- Water suction from external tank option (self priming pumps only TW)
- Hose reel with 20 mt hose can be mounted on request (cod. 00080-01521)

TECHNICAL DATA

| | Thermic 18 3518 BS | Thermic 22 3521 H | Thermic 22 4018 H | Thermic 22 5015 H | Thermic 22 2730 H |
|------------------------|-------------------------------|-------------------------------|-------------------------------|-------------------------------|-------------------------------|
| code | 36018-00043 | 36018-00042 | 36018-00041 | 36018-00040 | 36018-00045 |
| rated/max pressure | 350/360 bar - 5076/5221 psi | 350/360 bar - 5076/5221 psi | 400/415 bar - 5801/6019 psi | 500/520 bar - 7252/7541 psi | 270/280 bar - 3916/4061 psi |
| max delivery flow rate | 1080 l/h - 4.76 gpm | 1320 l/h - 5.8 gpm | 1110 l/h - 4.8 gpm | 990 l/h - 4.3 gpm | 1800 l/h - 7.92 gpm |
| engine type | B&S Vanguard | Honda GX 690/22 | Honda GX 690/22 | Honda GX 690/22 | Honda GX 690/22 |
| motor power | 18 hp | 22 hp | 22 hp | 22 hp | 22 hp |
| pump model | TW/1560 rpm | TW/1560 rpm | TW 500/1560 rpm | TW 500/1560 rpm | TW/1560 rpm |
| T max water inlet | 60°C | 60°C | 60°C | 60°C | 60°C |
| dimension (cm)/weight | 118,5x74x102/150 Kg (330 lbs) | 118,5x74x102/180 Kg (397 lbs) | 118,5x74x102/180 Kg (397 lbs) | 118,5x74x102/180 Kg (397 lbs) | 118,5x74x102/180 Kg (397 lbs) |

PLUS



Sturdy painted steel frame with vertical lifting bar, practical side hooks for accessories and protective stainless steel covers to preserve the motor pump from accidental impacts



Vanguard 18hp / Honda 22hp two-cylinder petrol engines with electric starter, automatic decelerator and 20-litre fuel tank









TW Premium / TW 500 pump with brass head and ceramic pistons



Foamed pneumatic wheels in solid rubber and 300 mm diameter steel rims for positioning stability and for movement operations

STANDARD EQUIPMENT

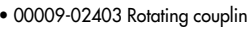
| | | | | |
|--|--|--|---|---|
|  <ul style="list-style-type: none"> • 00080-01098 Gun ML 955 - M24 with quick coupling (mod. Thermic 18 BS) |  <ul style="list-style-type: none"> • 00080-01100 Gun ML 710 with quick coupling M24-M24 (mod. Thermic 22H) |  <ul style="list-style-type: none"> • 10002-04020 lance SF40 M24 (Thermic 18 BS) |  <ul style="list-style-type: none"> • 10002-04022 Stainless steel Lance 500 bar L70 (mod. Thermic 22H) |  <ul style="list-style-type: none"> • 00080-01368 Nozzle 040 (mod. 3518 BS) • 00080-00319 Nozzle 050 (mod. 3521 H) • 00080-00317 Nozzle 040 (mod. 4018 H) |
|  <ul style="list-style-type: none"> • 00080-00355 Nozzle 028 (mod. 5015 H) • 00080-03341 Nozzle 075 (mod. 2730 H) |  <ul style="list-style-type: none"> • 10002-04110 High pressure hose 10 m (Thermic 18 BS) • 10002-04111 High pressure hose 10 m (Thermic 22H) |  <ul style="list-style-type: none"> • 00009-02403 Rotating coupling | | |

OPTIONAL

| | | | | |
|--|---|---|--|---|
| <ul style="list-style-type: none"> • Turbo lance code: 10002-04104 (mod.3518) 10002-04097 (mod.3521) 10002-04096 (mod.4018) 10002-04094 (mod.5015) • mod. 2730 on request | <ul style="list-style-type: none"> • Pipe cleaning hose 25 m. code: 00058-00650 (mod.3518) 00058-00649 (mod.3521/4018) 00058-00648 (mod.5015) • mod. 2730 on request | <ul style="list-style-type: none"> • Extension hose code: 10002-04106 (mod.3518) 10 m. 10002-04099 (mod.3521/2730) 20 m. 10002-04098 (mod.4018/5015) 20 m. | <ul style="list-style-type: none"> • Sand-blasting lance 500 bar code: 10002-04108 (mod.3518) 10002-04102 (mod.3521) 10002-04101 (mod.4018) 10002-04100 (mod.5015) • mod. 2730 on request | <ul style="list-style-type: none"> • 00069-00223 Apron |
|--|---|---|--|---|

Thermic 26 K

Powered by
**KOHLER
DIESEL**



MORE INFO



CHARACTERISTICS

- TW Premium/TW 500 bar Premium pumps with brass pump head and ceramic pistons
- Kohler engine KDW1003 liquid cooler
- Gearbox (with 1450 rpm)
- Electrical starting
- No engine-oil safety device (oil-alert)
- **Hour counter**
- Manual accelerator
- Stainless steel gradual pressure restoration valve with EASY-START
- Thermostatic valve
- Water filter, readily serviceable cartridge type
- Water suction from external tank option (self priming pumps only TW)
- Ø 350 industrial wheels
- Hose reel with 20 mt hose can be mounted (00080-01539)

TECHNICAL DATA

| | Thermic 26 3523 K | Thermic 26 4020 K | Thermic 26 5016 K |
|------------------------|-----------------------------|-----------------------------|-----------------------------|
| code | 36018-00048 | 36018-00047 | 36018-00046 |
| rated/max pressure | 350/360 bar - 5076/5221 psi | 400/415 bar - 5801/6019 psi | 500/520 bar - 7252/7541 psi |
| max delivery flow rate | 1380 l/h - 6.07 gpm | 1200 l/h - 5.28 gpm | 990 l/h - 4.3 gpm |
| engine type | Kohler 1003 Diesel | Kohler 1003 Diesel | Kohler 1003 Diesel |
| motor power | 26 hp | 26 hp | 26 hp |
| pump model | TW 500/1450 rpm | TW 500/1450 rpm | TW 500/1450 rpm |
| T max water inlet | 60°C | 60°C | 60°C |
| dimension (cm)/weight | 137x85x102/300 Kg (661 lbs) | 137x85x102/300 Kg (661 lbs) | 137x85x102/300 Kg (661 lbs) |

PLUS



Industrial pneumatic wheels in solid rubber and steel rims with a diameter of 350 mm for stability of positioning and for movement operations



Sturdy painted steel frame with vertical lifting bar, practical side hooks for accessories and protective stainless steel covers to preserve the motor pump from accidental impacts







Kohler KDW 1003 water-cooled engine, 3 cylinders in line to minimise vibrations



TW Premium / TW 500 pump with brass head and ceramic pistons

STANDARD EQUIPMENT

| | | | | |
|--|--|---|--|---|
|  <ul style="list-style-type: none"> • 00080-01100 Gun ML 710 with quick coupling M24-M24 |  <ul style="list-style-type: none"> • 00080-01738 Lance with ventilated protection |  <ul style="list-style-type: none"> • 00080-03328 Nozzle 043 (mod. 4020) • 00080-03272 Nozzle 030 (mod. 5016/3523) |  <ul style="list-style-type: none"> • 10002-03954 High pressure hose 10 m | <ul style="list-style-type: none"> • 00009-02403 Rotating coupling |
|--|--|---|--|---|

OPTIONAL

| | | | | |
|--|---|---|--|--|
| <ul style="list-style-type: none"> • Turbo lance with nozzle 600 bar code: 10002-04097 (mod.3523) 10002-04150 (mod.4020) 10002-04094 (mod.5016) | <ul style="list-style-type: none"> • Pipe cleaning hose 25 m. code: 00058-00649 (mod.3523/4020) 00058-00648 (mod.5016) | <ul style="list-style-type: none"> • Extension hose 20 m. code: 10002-04099 (mod.3523) 10002-04098 (mod.4020/5016) | <ul style="list-style-type: none"> • Sand-blasting lance 500 bar code: 10002-04102 (mod.3523) 10002-04101 (mod.4020) 10002-04100 (mod.5016) | <ul style="list-style-type: none"> • 00069-00223 Apron • 00069-00250 Helmet kit + apron + hand protections + gaiters |
|--|---|---|--|--|

Thermic 31 7015 BS



MORE INFO



CHARACTERISTICS

- ø 300 mm 4 wheels with foamed-acting pneumatic
- 31 HP B&S Vanguard engines
- TW 700 triplex pump
- Gearbox (with 1560 rpm pump)
- Electrical starting
- RPM manual regulator
- Stainless steel gradual pressure relief valve with EASY START
- Stainless steel pressure gauge
- Safety valve
- Thermostatic valve
- Big water filter at pump inlet, readily serviceable cartridge type
- Suitable for high professional use

TECHNICAL DATA

| | Thermic 31 7015 BS |
|------------------------|-------------------------------|
| code | 36018-00062 |
| rated/max pressure | 700/770 bar - 10152/11167 psi |
| max delivery flow rate | 900 l/h - 3.96 gpm |
| engine type | B&S vanguard |
| motor power | 31 hp |
| pump model | TW 700/1560 rpm |
| T max water inlet | 60°C |
| dimension (cm)/weight | 100x82x85/300 Kg (661 lbs) |

PLUS



Standard 1000 bar accessories , oversized to ensure the highest level of safety for the operator



Sturdy painted steel frame with vertical lifting bar, practical side hooks for accessories and protective stainless steel covers to preserve the motor pump from accidental impacts



TW Premium 700 pump with nickel-plated brass head and ceramic pistons



Foamed pneumatic wheels in solid rubber and 300 mm diameter steel rims for positioning stability and for movement operations

STANDARD EQUIPMENT

| | | | | |
|---|---|---|---|--|
|  <ul style="list-style-type: none"> • 00080-04562 Gun RL1100 with lance |  <ul style="list-style-type: none"> • 00080-04553 Nozzle type 020 700 bar |  <ul style="list-style-type: none"> • 00042-00243 Safety sock for gun |  <ul style="list-style-type: none"> • 00070-00710 Self-cleaning filter 1" G |  <ul style="list-style-type: none"> • 00014-00520 High pressure hose with safety sock 20 m |
|---|---|---|---|--|

OPTIONAL

| | | | | |
|--|---|---|--|--|
| <ul style="list-style-type: none"> • 00080-04623 Turbo nozzle | <ul style="list-style-type: none"> • 00080-01225 Sand blasting lance |  <ul style="list-style-type: none"> • 00069-00250 Helmet kit + apron + hand protections + gaiters | | |
|--|---|---|--|--|

Thermic 26 7013 K



Powered by
**KOHLER
 DIESEL**



MORE INFO



CHARACTERISTICS

- 4 twin solid wheels 350mm diameter • Kohler KDW1003 Diesel liquid cooled engine (26hp) • TW 700 triplex pumps • Gearbox (with 1450 rpm)
- Electrical starting • Hours meter • RPM manual regulator • Stainless steel gradual pressure relief valve with EASY START • Stainless steel pressure gauge • Safety valve • Thermostatic valve • Big water filter at pump inlet, readily serviceable cartridge type • Suitable for high professional use

TECHNICAL DATA

| | Thermic 26 7013 K |
|------------------------|-------------------------------|
| code | 36018-00063 |
| rated/max pressure | 700/770 bar - 10152/11167 psi |
| max delivery flow rate | 780 l/h - 3.43 gpm |
| engine type | Kohler KDW1003 Diesel |
| motor power | 26 hp |
| pump model | TW 700/1450 rpm |
| T max water inlet | 60°C |
| dimension (cm)/weight | 137x85x102/300 Kg (661 lbs) |

PLUS



Standard 1000 bar accessories , oversized to ensure the highest level of safety for the operator



Sturdy painted steel frame with vertical lifting bar, practical side hooks for accessories and protective stainless steel covers to preserve the motor pump from accidental impacts



Kohler KDW 1003 water-cooled engine, 3 cylinders in line to minimise vibrations



TW Premium 700 pump with nickel-plated brass head and ceramic pistons

STANDARD EQUIPMENT

| | | | | |
|---|---|---|--|--|
|  <ul style="list-style-type: none"> • 00080-04562 Gun RL1100 with lance |  <ul style="list-style-type: none"> • 00080-04552 Nozzle type 025 700 bar |  <ul style="list-style-type: none"> • 00042-00243 Safety sock for gun | |  <ul style="list-style-type: none"> • 00014-00520 High pressure hose with safety sock 20 m |
|---|---|---|--|--|

OPTIONAL

| | | | | |
|--|---|---|--|--|
| <ul style="list-style-type: none"> • 00080-04622 Turbo nozzle | <ul style="list-style-type: none"> • 00080-01226 Sand blasting lance |  <ul style="list-style-type: none"> • 00069-00250 Helmet kit + apron + hand protections + gaiters | | |
|--|---|---|--|--|

The hot water high-pressure cleaner is the best tool for tough or non water-soluble dirt removal.

Suitable for different uses and ideal in several sectors like agriculture, food industry and primary and secondary building.

Excellent for machines washing like: tools, engines, farm tractors and means of transport (oily dirt); removal or animal and vegetable residuals (stables and food industry), washing of heavy building equipments (cement mixers, cranes, earth-moving equipments etc.). In the food industry has a perfect hygienising effect.



Why a hot water high-pressure cleaner?

It is necessary the use of a hot water high-pressure cleaner whenever it is necessary to degrease oily or particularly tough dirt in the shortest time possible. Washing efficiency of hot water is much higher than the cold water one (up to 50% higher on some kind of dirt), because heat assists dirt degrease. Heat effect on the surface produce also fast drying. With the use of a hot water high-pressure cleaner it is possible to have: shorter washing time (under the same kind of dirt), better degrease of non water-soluble dirt, shorter drying time and less quantity of chemical product used: in few words, lower cleaning fixed costs and water saving.

The boiler

It is a diesel fuel heater that raises water temperature coming out of the pump; the difference between inlet and outlet water temperature is technically indicated like Delta T.

Boiler dimensions, in other words coil and diesel fuel consumption, determine the thermal power of the burner.

Under the same conditions, increasing the delivery rate (quantity of water to be heated) the Delta T decreases proportionally. It is easy to understand why high pressure cleaners with higher delivery rates have more powerful burners: to grant the best operating temperature in each working condition. All our boilers have very high thermal efficiency, near 90% or higher. This means very low operating cost with reference to diesel fuel consumption.



- **Linear pump:**

The movement of the (3) pistons occurs through a system of connecting rods and crankshaft. The longitudinal axle of the pistons (placed at the same level or linear) is perpendicular to the motor rotation axle. It is more versatile to bear high delivery rates (from 21 l/min) and it has a better self priming.



- **Water cooled motor:**

Water flows through the Stainless steel coil around the motor, this allows a better thermal exchange (and so a cooling) than air also in those countries where inlet water could reaches 60°C. This allows a drop in operating temperature of the motor and pump mechanical elements, granting a better reliability and longer life.



- **Thermal valve:**

When the gun trigger is released, the same water flows through the pump (by-pass) and it overheats and sooner or later this damages the valve seals. With this completely mechanical system, the thermal valve checks the temperature in the pump, opening/closing the by-pass circuit letting new and fresh water flow inside before the elements are damaged. Simple solution without electronic devices.



- **Total Stop:**

Releasing the gun trigger the pump stops automatically avoiding element damages during the by-pass phase. Pulling the trigger, the high-pressure cleaner starts automatically. Max pump protection.



- **Low voltage and delayed Total Stop:**

To avoid quick and multiple start and shut down of the motor/pump group whenever the gun trigger is pulled and released, this disposal delays of about 15 seconds the machine shut down. Prevention, energy saving, top safety and pump longer life.



- **Low voltage and delayed Total Stop with intelligent shut down:** To avoid quick and multiple start and shut down of the motor/pump group whenever the gun trigger is pulled and released, this disposal delays of about 15 seconds the machine shut down. In case the machine is unused for more than 20 minutes or there are leakages in the pressure circuit, the machine shuts down automatically and completely: control panel power cut-off. Prevention, energy saving, top safety and pump longer life.



- **Motor low rotation speed:**

The electric motor transfers the same number of revolutions to the pump. With a 4 poles motor there is a lower rotation speed of the components (1400 RPM in case of 50Hz or 1750 RPM in case of 60 Hz) granting longer pump life. Extending lifetime solution.



- **Pump with nickel-plated brass head:**

The nickel-plating treatment improves the basic features (greater hardness and improved resistance to the chemical products used in washing), reducing the deterioration caused by cavitation.

Technical information

| Code | Model | pag | operating pressure (max pressure) | operating pressure (max pressure) | delivery rate | delivery rate | absorbed power | rpm | voltage | outlet temp. | fuel consumption | diesel tank | antiscald tank | heat output | packaging | packaging weight |
|-------------|---------------------|-----|--------------------------------------|--------------------------------------|---------------|---------------|----------------|------|---------|--------------|------------------|-------------|----------------|-------------|------------|------------------|
| | | | bar | psi | l/h | GPM usa | W | RPM | V | °C | l/h - gal/h | l - gal | l - gal | kW | cm | Kg - lbs |
| 36093-00001 | DARWIN 1310 XP | 88 | 30÷130(150) | 435÷1885(2175) | 345÷600 | 1.52-2.64 | 3000 | 2800 | 230-50 | max 90° | - | - | - | 20 | 80x55x100 | 80 - 176 |
| 36093-00002 | DARWIN PLUS 1310 XP | 88 | 30÷130(150) | 435÷1885(2175) | 345÷600 | 1.52-2.64 | 3000 | 2800 | 230-50 | max 90° | - | - | - | 20 | 80x55x100 | 82 - 180 |
| 36081-00003 | DAKOTA R 1509 XP | 90 | 30÷150(160) | 435÷2175(2320) | 330÷540 | 1.45÷2.91 | 3200 | 2800 | 230-50 | max 110° | 3,78 - 1.0 | 16 - 4.2 | - | 42 | 69x85x111 | 94 - 207 |
| 36081-00004 | DAKOTA R 2007 XP | 90 | 30÷200(210) | 435÷2900(3045) | 330÷420 | 1.45÷2.91 | 4000 | 2800 | 400-50 | max 110° | 3,78 - 1.0 | 16 - 4.2 | - | 42 | 69x85x111 | 97 - 213 |
| 36081-00005 | DAKOTA R 1713 XP | 90 | 30÷170(190) | 435÷2465(2755) | 400÷780 | 1.76÷3.43 | 4700 | 2800 | 400-50 | max 110° | 3,78 - 1.0 | 16 - 4.2 | - | 42 | 69x85x111 | 95 - 209 |
| 36071-00001 | NPX 1211 XP | 92 | 30÷120(150) | 435÷1740(2175) | 330÷660 | 1.45÷2.91 | 3200 | 2800 | 230-50 | max 110° | 4,72 - 1.25 | 18 - 4.8 | - | 58 | 71x113x111 | 118 - 260 |
| 36071-00017 | NPX 1813 XP | 92 | 30÷180(210) | 435÷2610(3045) | 400÷780 | 1.76÷3.43 | 6300 | 2800 | 400-50 | max 110° | 4,72 - 1.25 | 18 - 4.8 | - | 58 | 71x113x111 | 117.5 - 259 |
| 36080-00002 | TEXAS R 1211 | 94 | 30÷120(150) | 435÷1740(2175) | 330÷660 | 1.45÷2.91 | 3000 | 1400 | 230-50 | max 110° | 3,78 - 1.0 | 16 - 4.2 | - | 42 | 69x85x111 | 104 - 229 |
| 36080-00004 | TEXAS R 1611 | 94 | 30÷160(180) | 435÷2320(2610) | 400÷660 | 1.76÷2.91 | 4300 | 1400 | 400-50 | max 110° | 3,78 - 1.0 | 16 - 4.2 | - | 42 | 69x85x111 | 104 - 229 |
| 36080-00008 | HSR 1509 LP | 96 | 30÷150(160) | 435÷2175(2320) | 345÷540 | 1.52-2.40 | 3000 | 1400 | 230-50 | max 110° | 3,78 - 1.0 | 16 - 4.2 | - | 42 | 69x85x111 | 120 - 264 |
| 36072-00167 | LKX 1310 LP | 98 | 30÷110(150) | 435÷1595(2175) | 330÷660 | 1.45÷2.91 | 3000 | 1400 | 230-50 | max 110° | 4,72 - 1.25 | 18 - 4.8 | - | 58 | 71x113x111 | 130.5 - 287 |
| 36072-00159 | LKX 1515 LP | 98 | 30÷150(180) | 435÷2175(2610) | 450÷900 | 1.98÷3.96 | 5500 | 1400 | 400-50 | max 110° | 5,6 - 1.5 | 18 - 4.8 | - | 74 | 71x113x111 | 143.4 - 316 |
| 36072-00160 | LKX 2015 LP | 98 | 30÷200(230) | 435÷2900(3335) | 450÷900 | 1.98÷3.96 | 7300 | 1400 | 400-50 | max 110° | 5,6 - 1.5 | 18 - 4.8 | - | 74 | 71x113x111 | 146 - 322 |
| 36072-00179 | HLR 1211 LP | 100 | 30÷110(150) | 435÷1595(2175) | 345÷660 | 1.52-2.91 | 3000 | 1400 | 230-50 | max 110° | 4,72 - 1.25 | 18 - 4.8 | - | 58 | 71x113x111 | 127 - 279 |
| 36072-00180 | HLR 1510 LP | 100 | 30÷150(180) | 435÷2175(2610) | 345÷600 | 1.52-2.64 | 3000 | 1400 | 230-50 | max 110° | 4,72 - 1.25 | 18 - 4.8 | - | 58 | 71x113x111 | 127 - 279 |
| 36072-00181 | HLR 1614 LP | 102 | 30÷160(190) | 435-2320(2755) | 345-840 | 1.52-3.70 | 4200 | 1400 | 400-50 | max 110° | 4,72 | 18 - 4,7 | - | 58 | 71x113x111 | 148,5 - 327 |
| 36072-00100 | HLR 1515 LP | 102 | 30÷150(180) | 435-2175(2610) | 345-900 | 1.52-3.96 | 5500 | 1400 | 400-50 | max 110° | 5,6 - 1.5 | 18 - 4,7 | - | 74 | 113x71x111 | 148,5 - 327 |
| 36072-00101 | HLR 2015 LP | 102 | 30÷200(230) | 435-2900(3335) | 450-900 | 1.98-3.96 | 7300 | 1400 | 400-50 | max 110° | 5,6 - 1.5 | 18 - 4,7 | - | 74 | 113x71x111 | 148,5 - 327 |
| 36072-00102 | HLR 2021 LP | 102 | 30÷200(230) | 435-2900(3335) | 630-1260 | 2.77-5.55 | 9700 | 1400 | 400-50 | max 110° | 5,6 - 1.5 | 18 - 4,7 | - | 74 | 113x71x111 | 148,5 - 327 |
| 36073-00002 | TEKNA 2015 LP | 104 | 30÷200(230) | 435-2900(3335) | 450-900 | 1.98-3.96 | 7300 | 1400 | 400-50 | max 110° | 4,72 - 1.25 | 22 - 5.8 | 2,4 - 0.6 | 58 | 130x78x111 | 172 - 379 |



| Code | Model | pag | operating pressure (max pressure) | operating pressure (max pressure) | delivery rate | delivery rate | absorbed power | rpm | voltage | outlet temp. | fuel consumption | diesel tank | antiscal tank | heat output | packaging | packaging weight |
|-------------|----------------------|-----|--------------------------------------|--------------------------------------|---------------|---------------|----------------|------|----------|--------------|------------------|-------------|---------------|-------------|-------------|------------------|
| | | | bar | psi | l/h | GPM usa | W | RPM | V | °C | l/h - gal/h | l - gal | l - gal | kW | cm | Kg - lbs |
| 36073-00021 | TEKNA 2021 LP | 104 | 30÷200(230) | 435÷2900(3335) | 630÷1260 | 2.77÷5.55 | 9700 | 1400 | 400-50 | max 110° | 6,6 - 1,75 | 22 - 5,8 | 2,4 - 0,6 | 88 | 130x78x111 | 180 - 396 |
| 36074-00040 | HTR 2015 LP | 106 | 30÷200(230) | 435÷2900(3335) | 450÷900 | 1.98÷3.96 | 7300 | 1400 | 400-50 | max 110° | 6,6 - 1,75 | 22 - 5,8 | 2,4 | 88 | 130x78x111 | 187 - 412 |
| 36074-00041 | HTR 2021 LP | 106 | 30÷200(230) | 435÷2900(3335) | 630÷1260 | 2.77÷5.55 | 9700 | 1400 | 400-50 | max 110° | 6,6 - 1,75 | 22 - 5,8 | 2,4 | 88 | 130x78x111 | 181,5 - 400 |
| 36074-00052 | HTR 2515 LP | 106 | 30÷250(280) | 435÷3600(4061) | 450÷900 | 1.98÷3.96 | 8700 | 1400 | 400-50 | max 110° | 6,6 - 1,75 | 22 - 5,8 | 2,4 | 88 | 130x78x111 | 187 - 412 |
| 36034-00015 | HMR 2015 LP | 108 | 30÷190(200) | 435÷2755(2900) | 450÷900 | 1.98÷3.96 | 6000 | 1400 | 400-50 | max 110° | - | - | - | 55 | 90x65x87 | 160 - 352 |
| 36034-00016 | HMR 1521 LP | 108 | 30÷150(160) | 435÷2175(2320) | 630÷1260 | 2.77÷5.55 | 6000 | 1400 | 400-50 | max 110° | - | - | - | 55 | 90x65x87 | 160 - 352 |
| 36034-00017 | HMR 2021 LP | 108 | 30÷190(200) | 435÷2755(2900) | 630÷1260 | 2.77÷5.55 | 6000 | 1400 | 400-50 | max 110° | - | - | - | 55 | 90x65x87 | 160 - 352 |
| 36075-00046 | HHPV 1211 LP | 110 | 30÷100(110) | 435÷1450(1595) | 345÷720 | 1.52÷2.9 | 3000 | 1400 | 230 - 50 | max 110° | 4,72 - 1,25 | 20 - 5,3 | - | 58 | 80x120x185 | 199 - 438 |
| 36075-00044 | HHPV 2015 LP | 110 | 30÷200(230) | 435÷2900(3335) | 450÷900 | 1.98÷3.96 | 7300 | 1400 | 400 - 50 | max 110° | 4,72 - 1,25 | 20 - 5,3 | - | 58 | 80x120x185 | 199 - 438 |
| 36075-00048 | HHPV 2021 LP | 110 | 30÷200(230) | 435÷2900(3335) | 630÷1260 | 2.77÷5.55 | 9700 | 1400 | 400 - 50 | max 110° | 4,72 - 1,25 | 20 - 5,3 | - | 58 | 80x120x185 | 210 - 463 |
| 36075-00045 | HHPV 1211 LP | 110 | 30÷120(150) | 435÷1740(2175) | 345÷720 | 1.52÷2.9 | 3000 | 1400 | 230 - 50 | max 110° | 4,72 - 1,25 | 20 - 5,3 | - | 58 | 80x120x185 | 199 - 438 |
| 36075-00043 | HHPV 2015 LP | 110 | 30÷200(230) | 435÷2900(3335) | 450÷900 | 1.98÷3.96 | 7300 | 1400 | 400 - 50 | max 110° | 4,72 - 1,25 | 20 - 5,3 | - | 58 | 80x120x185 | 199 - 438 |
| 36075-00047 | HHPV 2021 LP | 110 | 30÷200(230) | 435÷2900(3335) | 630÷1260 | 2.77÷5.55 | 9700 | 1400 | 400 - 50 | max 110° | 4,72 - 1,25 | 20 - 5,3 | - | 58 | 80x120x185 | 210 - 463 |
| 36111-00032 | THERMIC 10.1 HW 1621 | 112 | 30÷160(180) | 435÷2320(2610) | 1020 | 4,4 | 10 hp | 1560 | - | max 140° | - | - | - | 60 | 136x105x120 | 200 - 440 |
| 36111-00031 | THERMIC 10.1 HW 2016 | 112 | 30÷200(230) | 435÷2900(3335) | 450÷960 | 1.98÷4.2 | 9,3 hp | 1560 | - | max 110° | - | - | - | - | 136x105x120 | 200 - 440 |
| 36033-00013 | THERMIC 26 HW 2523 | 114 | 30÷250(275) | 435÷3600(3988) | 400÷1380 | 1.76÷6.0 | 26 hp | 1450 | - | max 110° | - | - | - | - | 125x85x105 | 450 - 992 |
| 36033-00014 | THERMIC 26 HW 3518 | 114 | 30÷350(375) | 435÷5076(5438) | 400÷1140 | 1.76÷5 | 26 hp | 1450 | - | max 110° | - | - | - | - | 125x85x105 | 450 - 992 |
| 36033-00015 | THERMIC 26 HW 2030 | 114 | 30÷200(210) | 435÷2900(3045) | 400÷1800 | 1.76÷7.9 | 26 hp | 1450 | - | max 110° | - | - | - | - | 125x85x105 | 450 - 992 |
| 38003-00001 | VULCANO 74 | 116 | 30÷120(200) | 435÷1740(2900) | 1260 | 5.55 | 300 | - | 230-50 | max 110° | 5,6 - 1,5 | 18 - 4,8 | - | 74 | 113x71x111 | 103,6 - 228 |



Darwin



MORE INFO



DARWIN PLUS

MORE INFO



DARWIN

CHARACTERISTICS

- Boiler ventilation unit built-on motorpump (energy saving) • Three ceramic coated pistons, brass axial pump head with built-in by-pass valve with double gasket • Suction and delivery Stainless steel valves • Vertical burner with high thermal efficiency steel coil • Temperature regulation gauge • Pivoting wheel with brake • Diesel pump with discharge by-pass valve • Detergent built-in tank (3,5 lt) for indirect suction • Possibility to integrated detergent suction with external probe • Diesel tank capacity (15 lt) • Glycerine pressure gauge • Metal lance • Accessory holder • Ergonomic handle • Integrated hose reel with 10m hp hose (only model Plus code 36093-00002)

TECHNICAL DATA

| | Darwin 1310 XP | Darwin Plus 1310 XP |
|--------------------------|-----------------------------|-----------------------------|
| code | 36093-00001 | 36093-00002 |
| rated/max pressure | 130/150 bar - 1885/2175 psi | 130/150 bar - 1885/2175 psi |
| max delivery flow rate | 600 l/h - 2.64 gpm | 600 l/h - 2.64 gpm |
| abs. power/supply | 3000 W/230V 1~50Hz | 3000 W/230V 1~50Hz |
| motor power | 2,0 kW | 2,0 kW |
| pump model | MPBX1/2800 rpm | MPBX1/2800 rpm |
| T max water inlet/outlet | 40/90 °C | 40/ 90°C |
| dimension (cm)/weight | 80x55x100/80 Kg (176 lbs) | 80x55x100/82 Kg (180 lbs) |

PLUS



Handy pressure connected hose reel to use only the necessary length of hose and to easily rewind it after use (Plus 36093-00002 model)



Shockproof front and rear protective bar , ideal for manual lifting



Removable handle without the use of tools to compact or to facilitate transportation



Cleaning tank with suction quantity adjustment system, possibility of suction from external tank

STANDARD EQUIPMENT

| | | | | |
|---|---|---|--|--|
|  <ul style="list-style-type: none"> • 00080-01701 Gun M22 - 3/8 |  <ul style="list-style-type: none"> • 00080-04943 Lance M22 high/low pressure |  <ul style="list-style-type: none"> • 00080-03186 Nozzle type 035 |  <ul style="list-style-type: none"> • 00080-02254 High pressure hose 8 m (mod. 36093-00001) • 00080-04434 High pressure hose 10 m (mod. 36093-00002) |  <ul style="list-style-type: none"> • Storage bag (mod. 36093-00001) |
|---|---|---|--|--|

Dakota-R



MORE INFO



CHARACTERISTICS

- Three ceramic coated pistons, brass axial pump head with built-in by-pass valve.
- Low voltage and delayed Total Stop.
- Suction and delivery Stainless steel valves.
- Vertical burner with high thermal efficiency steel coil.
- Temperature regulation gauge.
- Low fuel lamp.
- Safety valve.
- Detergent built-in tank (4,2 lt) for indirect suction.
- Pressure regulator.
- Glycerine pressure gauge.
- Panel with analogic controls.
- Hose reel with brake **(optional)**.

TECHNICAL DATA

| | Dakota-R 1509 XP | Dakota-R 2007 XP | Dakota-R 1713 XP |
|--------------------------|-----------------------------|-----------------------------|-----------------------------|
| code | 36081-00003 | 36081-00004 | 36081-00005 |
| rated/max pressure | 150/160 bar - 2175/2320 psi | 200/210 bar - 2900/3045 psi | 170/190 bar - 2465/2755 psi |
| max delivery flow rate | 540 l/h - 2.37 gpm | 420 l/h - 1.84 gpm | 780 l/h - 3.43 gpm |
| abs. power/supply | 3200 W/230V 1~50Hz | 3300 W/230V 1~50Hz | 4700 W/400V 3~50Hz |
| motor power | 2,2 kW | 2,2 kW | 4,0 kW |
| pump model | MPBX2/2800 rpm | MPBX2/2800 rpm | MPBX2/2800 rpm |
| T max water inlet/outlet | 40/110 °C | 40/ 110°C | 40/ 110°C |
| dimension (cm)/weight | 85x65x97/92 Kg (202 lbs) | 85x65x97/94 Kg (207 lbs) | 85x65x97/95 Kg (209 lbs) |

PLUS



Side supports for gun and lance housing



Sturdy large diameter wheels for stability and ease of movement



Diesel oil level sensor with fuel shortage indicator light

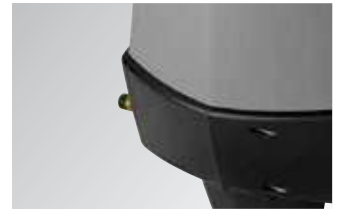

Oversized axial motor pump with integral ceramic pistons and brass head

STANDARD EQUIPMENT

| | | | | |
|--|---|--|---|--|
|  <ul style="list-style-type: none"> • 00080-01695 Gun M22 - 3/8 with rotating coupling |  <ul style="list-style-type: none"> • 00080-01715 Lance M22 high/low pressure |  <ul style="list-style-type: none"> • 00080-03185 Nozzle type 030 (mod. 1509) • 00080-03156 Nozzle type 1502 (mod. 2007) • 00080-03188 Nozzle type 045 (mod. 1713) |  <ul style="list-style-type: none"> • 00080-02254 High pressure hose 8 m | |
|--|---|--|---|--|

OPTIONAL

| | | | | |
|--|--|---|--|--|
| <ul style="list-style-type: none"> • 10001-10254 Hose reel with brake (hose not included) | <ul style="list-style-type: none"> • 00080-02254 8 m High pressure hose - 3/8" M22 - Ø 1/4" - 210 bar | <ul style="list-style-type: none"> • Turbo Lance code: 00080-02981 (mod. 1509) 00080-02986 (mod. 2007) 00080-02966 (mod. 1713) | <ul style="list-style-type: none"> • Sandblasting lance code: 00080-02957 (mod. 1509) 00080-02958 (mod. 1713) | |
|--|--|---|--|--|

NPX



MORE INFO



CHARACTERISTICS

- Three ceramic coated pistons, brass axial pump head with built-in by-pass valve.
- Low voltage and delayed Total Stop.
- Suction and delivery Stainless steel valves.
- Vertical burner with high thermal efficiency steel coil.
- Temperature regulation gauge.
- Low fuel lamp.
- Safety valve.
- Detergent built-in tank (3 lt) for indirect suction.
- Pressure regulator.
- Glycerine pressure gauge.
- Panel with analogic controls.
- Heavy duty steel frame.
- Accessory holder.
- Two ways fuel pump.
- Hose reel with brake **(optional)**.

TECHNICAL DATA

| | NPX 1211 XP | NPX 1813 XP |
|--------------------------|-----------------------------|-----------------------------|
| code | 36071-00001 | 36071-00017 |
| rated/max pressure | 120/150 bar - 1740/2175 psi | 180/210 bar - 2610/3045 psi |
| max delivery flow rate | 660 l/h - 2.91 gpm | 780 l/h - 3.43 gpm |
| abs. power/supply | 3200 W/230V 1~50Hz | 6300 W/400V 3~50Hz |
| motor power | 2,2 kW | 4,0 kW |
| pump model | MPBX2/2800 rpm | MPBX2/2800 rpm |
| T max water inlet/outlet | 40/110 °C | 40/110 °C |
| dimension (cm)/weight | 94x65x90/97 Kg (213 lbs) | 94x65x90/99 Kg (217 lbs) |

PLUS



4 twinned solid wheels to facilitate movement on any type of surface



Optional hose reel kit (max 30 meters of high pressure hose)







Side supports for gun and lance housing



Large ergonomic rear handles to facilitate the movement of the high pressure cleaner

STANDARD EQUIPMENT

| | | | | |
|--|---|--|---|--|
|  <ul style="list-style-type: none"> • 00080-01695 Gun M22 - 3/8 with rotating coupling |  <ul style="list-style-type: none"> • 00080-01715 Lance M22 high/low pressure |  <ul style="list-style-type: none"> • 00080-03188 Nozzle type 045 (mod. 1211) • 00080-03187 Nozzle type 040 (mod. 1813) |  <ul style="list-style-type: none"> • 00080-02347 High pressure hose 10 m | |
|--|---|--|---|--|

OPTIONAL

| | | | | |
|--|--|---|--|--|
| <ul style="list-style-type: none"> • 10001-13221 Hose reel with brake (hose not included) | <ul style="list-style-type: none"> • High pressure hose code: 00080-02258 10 m - 310 bar 00080-02261 20 m - 400 bar 00080-02264 10 m R2 | <ul style="list-style-type: none"> • 00080-02966 Lance Turbo type 1 M22 - 0,45 | <ul style="list-style-type: none"> • 00080-02957 Sandblasting lance | |
|--|--|---|--|--|

Texas-R



MORE INFO



CHARACTERISTICS

- 4 poles electrical motor (1400 rpm) with thermal protection.
- Three ceramic coated pistons (1 ph), full ceramic pistons (3 ph), brass linear pump head with built-in by-pass valve.
- Low voltage and delayed Total Stop.
- Suction and delivery Stainless steel valves.
- Vertical burner with high thermal efficiency steel coil.
- Temperature regulation gauge with high sensitive stainless steel sensor.
- Detergent built-in tank (4,2 lt) for indirect suction.
- Auxiliary motor for burner.
- Hose reel with brake (**optional**).

TECHNICAL DATA

| | Texas-R 1211 LP | Texas-R 1611 LP |
|--------------------------|-----------------------------|-----------------------------|
| code | 36080-00002 | 36080-00004 |
| rated/max pressure | 120/150 bar - 1740/2175 psi | 160/180 bar - 2320/2610 psi |
| max delivery flow rate | 660 l/h - 2.91 gpm | 660 l/h - 2.91 gpm |
| abs. power/supply | 3000 W/230V 1~50Hz | 4300 W/400V 3~50Hz |
| motor power | 2,2 kW | 4,0 kW |
| pump model | MP3/1400 rpm | MP3.5/1400 rpm |
| T max water inlet/outlet | 40/110 °C | 40/110 °C |
| dimension (cm)/weight | 85x65x97/112 Kg (246 lbs) | 85x65x97/128 Kg (282 lbs) |

PLUS



Side supports for gun and lance housing



Sturdy large diameter wheels for stability and ease of movement







Professional motor pump with 4-pole motor (1400 rpm) and self-priming linear pump: the low rotation speed significantly extends the life of the components inside the motor pump, guaranteeing greater efficiency and silence



Diesel oil level sensor with fuel shortage indicator light

STANDARD EQUIPMENT

| | | | | |
|--|---|--|--|--|
|  <ul style="list-style-type: none"> • 00080-01695 Gun M22 - 3/8 with rotating coupling |  <ul style="list-style-type: none"> • 00080-01715 Lance M22 high/low pressure |  <ul style="list-style-type: none"> • 00080-03188 Nozzle type 045 (mod. 1211) • 00080-03186 Nozzle type 035 (mod. 1611) |  <ul style="list-style-type: none"> • 00080-02254 High pressure hose 8 m (mod. 1211) • 00080-02347 High pressure hose 10 m (mod. 1611) | |
|--|---|--|--|--|

OPTIONAL

| | | | | |
|--|--|---|--|--|
| <ul style="list-style-type: none"> • 10001-10254 Hose reel with brake (hose not included) | <ul style="list-style-type: none"> • High pressure hose code: 00080-02254 8 m - 210 bar (mod. 1211) 00080-02258 10 m - 310 bar 00080-02261 20 m - 400 bar 00080-02264 10 m R2 | <ul style="list-style-type: none"> • Turbo Lance code: 00080-02966 00080-02981 | <ul style="list-style-type: none"> • 00080-02957 Sandblasting lance | |
|--|--|---|--|--|

HSR



MORE INFO



CHARACTERISTICS

- 4 poles electrical motor (1400 rpm) with thermal protection.
- Three ceramic coated pistons.
- Built-in by-pass valve nickel plating brass linear pump head with high temperature water seals and bushing.
- Low voltage and delayed Total Stop.
- Suction and delivery Stainless steel valves.
- Vertical burner with high thermal efficiency steel coil.
- Temperature regulation gauge with high sensitive stainless steel sensor.
- Detergent built-in tank (4,2 lt) for indirect suction.
- Auxiliary motor for burner.
- Heavy duty steel frame.
- Hose reel with brake **(optional)**.

TECHNICAL DATA

| | HSR 1509 LP |
|--------------------------|-----------------------------|
| code | 36080-00008 |
| rated/max pressure | 150/160 bar - 2175/2320 psi |
| max delivery flow rate | 540 l/h - 2.38 gpm |
| abs. power/supply | 3000 W/230V 1~50Hz |
| motor power | 2,2 kW |
| pump model | MP3 Ni/1400 rpm |
| T max water inlet/outlet | 60/110 °C |
| dimension (cm)/weight | 85x65x97/113 Kg (275 lbs) |

PLUS



Side supports for gun and lance housing



Sturdy large diameter wheels for stability and ease of movement







Professional motor pump with 4-pole motor (1400 rpm) and self-priming linear pump: the low rotation speed significantly extends the life of the components inside the motor pump, guaranteeing greater efficiency and silence



Pump head in nickel-plated brass and water seals for high temperatures for greater protection from chemicals or from other substances dissolved in water

STANDARD EQUIPMENT

| | | | | |
|--|---|---|---|--|
|  <ul style="list-style-type: none"> • 00080-01695 Gun M22 - 3/8 with rotating coupling |  <ul style="list-style-type: none"> • 00080-01715 Lance M22 high/low pressure |  <ul style="list-style-type: none"> • 00080-03185 Nozzle type 030 |  <ul style="list-style-type: none"> • 00080-02347 High pressure hose 10 m | |
|--|---|---|---|--|

OPTIONAL

| | | | | |
|--|---|--|--|--|
| <ul style="list-style-type: none"> • 10001-10254 Hose reel with brake (hose not included) | <ul style="list-style-type: none"> • High pressure hose code: 00080-02258 10 m - 310 bar 00080-02261 20 m - 400 bar 00080-02264 10 m R2 00080-02262 20 m - 400 bar 00080-02263 10 m - 400 bar food industry (mod.2015) | <ul style="list-style-type: none"> • 00080-02986 Turbo lance M22 - 0,30 | <ul style="list-style-type: none"> • 00080-02957 Sandblasting lance | |
|--|---|--|--|--|

LKX



Models: 1515 LP/
2015 LP

MORE INFO



CHARACTERISTICS

- 4 poles electrical motor (1400 rpm) with thermal protection and water cooling (three phase models).
- Three ceramic coated pistons (1 ph), full ceramic pistons (3 ph), brass linear pump head with built-in by-pass valve.
- Low voltage and delayed Total Stop.
- Suction and delivery Stainless steel valves.
- Vertical burner with high thermal efficiency steel coil.
- Temperature regulation gauge with high sensitive stainless steel sensor.
- Detergent built-in tank (3 lt) for indirect suction.
- Auxiliary motor for burner.
- Heavy duty steel frame.
- Hose reel with brake **(optional)**.

TECHNICAL DATA

| | LKX 1310 LP | LKX 1515 LP | LKX 2015 LP |
|--------------------------|-----------------------------|-----------------------------|-----------------------------|
| code | 36072-00167 | 36072-00159 | 36072-00160 |
| rated/max pressure | 110/150 bar - 1595/2175 psi | 150/180 bar - 2175/2610 psi | 200/230 bar - 2900/3335 psi |
| max delivery flow rate | 660 l/h - 2.91 gpm | 900 l/h - 3.96 gpm | 900 l/h - 3.96 gpm |
| abs. power/supply | 3000 W/230V 1~50Hz | 5500 W/400V 3~50Hz | 7300 W/400V 3~50Hz |
| motor power | 2,2 kW | 4,0 kW | 5,5 kW |
| pump model | MP3/1400 rpm | MPW3.5/1400 rpm | MPW3.5/1400 rpm |
| T max water inlet/outlet | 40/110 °C | 40/110 °C | 40/110 °C |
| dimension (cm)/weight | 94x65x90/112 Kg (246 lbs) | 94x65x90/125 Kg (275 lbs) | 94x65x90/128 Kg (282 lbs) |

PLUS



4 twinned solid wheels to facilitate movement on any type of surface



Optional hose reel kit (max 30 meters of high pressure hose)



Side supports for gun and lance housing







Professional motor pump with 4-pole motor (1400 rpm) and self-priming linear pump: the low rotation speed significantly extends the life of the components inside the motor pump, guaranteeing greater efficiency and silence

Other available versions:

- 36072-00165 LKX 2015 with header tank
- 36072-00184 LKX 2015 with header tank and antiscaling device

STANDARD EQUIPMENT

| | | | | |
|--|---|---|--|--|
|  <ul style="list-style-type: none"> • 00080-01695 Gun M22 - 3/8 with rotating coupling |  <ul style="list-style-type: none"> • 00080-01715 Lance M22 high/low pressure |  <ul style="list-style-type: none"> • 00080-03188 Nozzle type 045 (mod. 1310/2015) • 00080-03191 Nozzle type 060 (mod. 1515) |  <ul style="list-style-type: none"> • 00080-02347 High pressure hose 10 m | |
|--|---|---|--|--|

OPTIONAL

| | | | | |
|---|---|--|--|---|
| <ul style="list-style-type: none"> • 10001-13221 Hose reel with brake (hose not included) | <ul style="list-style-type: none"> • On request models with header tank and/or antiscaling device. | <ul style="list-style-type: none"> • 00073-00114 Antiscaling LC-PRECAL (pcs. 4 x 5 lt.) | <ul style="list-style-type: none"> • Turbo Lance code: 00080-02966 - (mod. 1310/2015) 00080-02967 - (mod. 1515) | <ul style="list-style-type: none"> • High pressure hose code: 00080-02258 10 m - 310 bar 00080-02261 20 m - 400 bar 00080-02264 10 m R2 00080-02262 20 m - 400 bar 00080-02263 10 m - 400 bar food industry (mod.2015) |
| <ul style="list-style-type: none"> • Sandblasting lance code: 00080-02957 (mod. 1310/2015) 00080-02958 (mod. 1515) | | | | |

HLR single phase



MORE INFO



CHARACTERISTICS

- 4 poles electrical motor (1400 rpm) with thermal protection and water cooling.
- Three ceramic coated pistons.
- Built-in by-pass valve nickel plating brass linear pump head with high temperature water seals and bushing.
- Low voltage and delayed Total Stop.
- Suction and delivery Stainless steel valves.
- Vertical burner with high thermal efficiency steel coil.
- Temperature regulation gauge with high sensitive stainless steel sensor.
- Detergent built-in tank (3 lt) for indirect suction.
- Auxiliary motor for burner.
- Heavy duty steel frame.
- Hose reel with brake **(optional)**.

TECHNICAL DATA

| | HLR 1211 LP | HLR 1510 LP |
|--------------------------|-----------------------------|-----------------------------|
| code | 36072-00179 | 36072-00180 |
| rated/max pressure | 110/150 bar - 1595/2175 psi | 150/180 bar - 2175/2610 psi |
| max delivery flow rate | 660 l/h - 2.91 gpm | 600 l/h - 2.64 gpm |
| abs. power/supply | 3000 W/230V 1~50Hz | 3000 W/230V 1~50Hz |
| motor power | 2,2 kW | 2,2 kW |
| pump model | MP3 Ni/1400 rpm | MP3 Ni/1400 rpm |
| T max water inlet/outlet | 60/110 °C | 60/110 °C |
| dimension (cm)/weight | 94x65x90/112 Kg (246 lbs) | 94x65x90/112 Kg (246 lbs) |

PLUS



4 twinned solid wheels to facilitate movement on any type of surface



Optional hose reel kit (max 30 meters of high pressure hose)







Side supports for gun and lance housing



Pump head in nickel-plated brass and water seals for high temperatures for greater protection from chemicals or from other substances dissolved in water

STANDARD EQUIPMENT

| | | | | |
|--|---|--|---|--|
|  <ul style="list-style-type: none"> • 00080-01695 Gun M22 - 3/8 with rotating coupling |  <ul style="list-style-type: none"> • 00080-01715 Lance M22 high/low pressure |  <ul style="list-style-type: none"> • 00080-03188 Nozzle type 045 (mod. 1211) • 00080-03185 Nozzle type 030 (mod. 1510) |  <ul style="list-style-type: none"> • 00080-02347 High pressure hose 10 m | |
|--|---|--|---|--|

OPTIONAL

| | | | | |
|--|--|---|--|--|
| <ul style="list-style-type: none"> • 10001-13221 Hose reel with brake (hose not included) | <ul style="list-style-type: none"> • High pressure hose code: 00080-02258 10 m - 310 bar 00080-02261 20 m - 400 bar 00080-02264 10 m R2 00080-02262 20 m - 400 bar 00080-02263 10 m - 400 bar food industry | <ul style="list-style-type: none"> • Turbo Lance code: 00080-02966 - (mod. 1211) 00080-02986 - (mod. 1510) | <ul style="list-style-type: none"> • 00080-02957 Sandblasting lance | |
|--|--|---|--|--|

HLR three phase



Models: 1515 LP
2015 LP/2021 LP



MORE INFO



CHARACTERISTICS

- 4 poles electrical motor (1400 rpm) with thermal protection and water cooling (except HLR 1614 LP model).
- Three ceramic pistons, three ceramic coated pistons (mod. 1614 LP)
- Built-in by-pass valve nickel plating brass linear pump head with high temperature water seals and bushing.
- Integrated elastic joint, for best pump coupling (1614 Excluded).
- Low voltage and delayed Total Stop.
- Suction and delivery Stainless steel valves.
- Vertical burner with high thermal efficiency steel coil.
- Temperature regulation gauge with high sensitive stainless steel sensor.
- Detergent built-in tank 3 l.
- Auxiliary motor for burner air cooling and mechanical two ways fuel pump.
- Hose reel **(optional)**.

TECHNICAL DATA

| | HLR 1614 LP | HLR 1515 LP | HLR 2015 LP | HLR 2021 LP |
|--------------------------|-----------------------------|-----------------------------|-----------------------------|-----------------------------|
| code | 36072-00181 | 36072-00100 | 36072-00101 | 36072-00102 |
| rated/max pressure | 160/190 bar - 2321/2755 psi | 150/180 bar - 2175/2610 psi | 200/230 bar - 2900/3335 psi | 200/230 bar - 2900/3335 psi |
| max delivery flow rate | 840 l/h - 3.70 gpm | 900 l/h - 3.96 gpm | 900 l/h - 3.96 gpm | 1260 l/h - 5.55 gpm |
| abs. power/supply | 4200 W/400V 3~50Hz | 5500 W/400V 3~50Hz | 7300 W/400V 3~50Hz | 9700 W/400V 3~50Hz |
| motor power | 4,0 kW | 4,0 kW | 5,5 kW | 7,5 kW |
| pump model | CL6.0 Ni/1400 rpm | CL6.0 Ni/1400 rpm | CL6.0 Ni/1400 rpm | CL6.0 Ni/1400 rpm |
| T max water inlet/outlet | 60/110 °C | 60/110 °C | 60/110 °C | 60/110 °C |
| dimension (cm)/weight | 94x65x90/109 Kg (240 lbs) | 94x65x90/127 Kg (280 lbs) | 94x65x90/129 Kg (284 lbs) | 94x65x90/131 Kg (288 lbs) |

PLUS



4 twinned solid wheels to facilitate movement on any type of surface



Built-in elastic joint for better pump/motor coupling

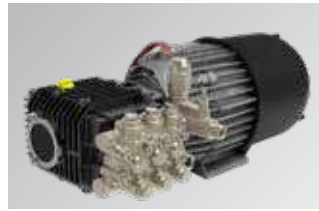

New CL 6.0 self-priming three-piston integral ceramic pump, tapered roller bearings, double oil viewer, nickel-plated brass head and high temperature water seal



New flanged pressure regulating valve L3.1, internal passages resized to ensure correct operation even in high operating flow conditions

STANDARD EQUIPMENT

| | | | | |
|--|---|--|---|--|
|  <ul style="list-style-type: none"> • 00080-01695 Gun M22 - 3/8 with rotating coupling |  <ul style="list-style-type: none"> • 00080-01715 Lance M22 high/low pressure |  <ul style="list-style-type: none"> • 00080-03186 Nozzle type 035 (mod. 1614) • 00080-03191 Nozzle type 060 (mod. 1515) • 00080-03188 Nozzle type 045 (mod. 2015) • 00080-03193 Nozzle type 070 (mod. 2021) |  <ul style="list-style-type: none"> • 00080-02347 High pressure hose 10 m | |
|--|---|--|---|--|

OPTIONAL

| | | | | |
|--|---|---|--|---|
| <ul style="list-style-type: none"> • 10001-13221 Hose reel with brake (hose not included) | <ul style="list-style-type: none"> • On request models with header tank and/or antiscaling device. | <ul style="list-style-type: none"> • 00073-00114 - Antiscaling LC-PRECAL (pz. 4 x 5 lt.) | <ul style="list-style-type: none"> • Turbo Lance code: 00080-02966 - (mod. 1614/2015) 00080-02967 - (mod. 1515) 00080-02968 - (mod. 2021) 00080-02986 - (mod. 1614) | <ul style="list-style-type: none"> • Sandblasting lance code: 00080-02957 (mod. 1614/2015) 00080-02958 (mod. 1515) • 00080-02959 (mod. 2021) |
| <ul style="list-style-type: none"> • High pressure hose code: 00080-02258 10 m - 310 bar 00080-02261 20 m - 400 bar 00080-02264 10 m R2 00080-02262 20 m - 400 bar 00080-02263 10 m - 400 bar food industry | | | | |

Tekna



MORE INFO



CHARACTERISTICS

- 4 poles electrical motor (1400 rpm) with thermal protection and water cooling. Three ceramic pistons, brass linear pump head with built-in by-pass valve.
- Low voltage and delayed Total Stop. • Suction and delivery Stainless steel valves. • Vertical burner with high thermal efficiency steel coil. • High pressure detergent flow with 22 liters integrated detergent tank • Auxiliary motor for burner air-cooling and two ways fuel pump. • Temperature regulation gauge with high sensitive stainless steel sensor. • Low fuel lamp and cut off. • Safety valve. • Header tank and antiscaling device. Panel with analogic controls. Hose reel (**optional**).

TECHNICAL DATA

| | Tekna 2015 LP | Tekna 2021 LP |
|--------------------------|-----------------------------|-----------------------------|
| code | 36073-00002 | 36073-00021 |
| rated/max pressure | 200/230 bar - 2900/3335 psi | 200/230 bar - 2900/3335 psi |
| max delivery flow rate | 900 l/h - 3.96 gpm | 1260 l/h - 5.55 gpm |
| abs. power/supply | 7300 W/400V 3~50Hz | 9700 W/400V 3~50Hz |
| motor power | 5,5 kW | 7,5 kW |
| pump model | CL6.0/1400 rpm | CL6.0/1400 rpm |
| T max water inlet/outlet | 40/110 °C | 40/110 °C |
| dimension (cm)/weight | 125x69x87/143 Kg (315 lbs) | 125x69x87/145 Kg (319 lbs) |

PLUS



Large 22-litre fuel and detergent tanks



New CL 6.0 self-priming pump with three pistons in integral ceramic, tapered roller bearings, double oil viewer and brass head







New flanged pressure regulating valve L3.1, internal passages resized to ensure correct operation even in high operating flow conditions



Easily removable side panels and upper fairing for faster maintenance

STANDARD EQUIPMENT

| | | | | |
|--|--|--|---|--|
|  <ul style="list-style-type: none"> • 00080-01695 Gun M22 - 3/8 with rotating coupling |  <ul style="list-style-type: none"> • 00080-01727 Lance M22 high pressure. |  <ul style="list-style-type: none"> • 00080-03188 Nozzle type 045 (mod. 2015 LP) • 00080-03193 Nozzle type 070 (mod. 2021 LP) |  <ul style="list-style-type: none"> • 00080-02347 High pressure hose 10 m | |
|--|--|--|---|--|

OPTIONAL

| | | | | |
|--|--|---|--|---|
| <ul style="list-style-type: none"> • 10001-10198 Hose reel with brake (hose not included) | <ul style="list-style-type: none"> • 00073-00114 Antiscale LC-PRECAL (pcs. 4 x 5 lt.) | <ul style="list-style-type: none"> • Turbo Lance code: 00080-02966 - (mod. 2015) 00080-02968 - (mod. 2021) | <ul style="list-style-type: none"> • High pressure hose code: 00080-02258 10 m - 310 bar (mod. 2015) 00080-02261 20 m - 400 bar 00080-02264 10 m R2 00080-02262 20 m - 400 bar 00080-02263 10 m - 400 bar food industry | <ul style="list-style-type: none"> • Sandblasting lance code: 00080-02957 (mod. 1614-2015) 00080-02958 (mod. 1515) |
|--|--|---|--|---|

HTR



MORE INFO



CHARACTERISTICS

- 4 poles electrical motor (1400 rpm) with thermal protection and water cooling.
- Three ceramic pistons, Nickel plating brass linear pump head with high temperature water seals and bushing.
- Integrated elastic joint, for best pump coupling.
- Low voltage and delayed Total Stop.
- Vertical burner with high thermal efficiency steel coil.
- High pressure detergent flow with 22 liters integrated detergent tank
- Auxiliary motor for burner air-cooling and two ways fuel pump.
- Temperature regulation gauge with high sensitive stainless steel sensor.
- Header tank and antiscaling device.
- Pressure accumulator for hose and gun vibrations prevention.
- Hose reel **(optional)**

TECHNICAL DATA

| | HTR 2015 LP | HTR 2021 LP | HTR 2515 LP |
|--------------------------|-----------------------------|-----------------------------|-----------------------------|
| code | 36074-00040 | 36074-00041 | 36074-00052 |
| rated/max pressure | 200/230 bar - 2900/3335 psi | 200/230 bar - 2900/3335 psi | 250/280 bar - 3600/4061 psi |
| max delivery flow rate | 900 l/h - 3.96 gpm | 1260 l/h - 5.55 gpm | 900 l/h - 3.96 gpm |
| abs. power/supply | 7300 W/400V 3~50Hz | 9700 W/400V 3~50Hz | 8700 W/400V 3~50Hz |
| motor power | 5,5 kW | 7,5 kW | 7,5 kW |
| pump model | CL6.0 Ni/1400 rpm | CL6.0 Ni/1400 rpm | CL6.0 Ni/1400 rpm |
| T max water inlet/outlet | 60/110 °C | 60/110 °C | 60/110 °C |
| dimension (cm)/weight | 125x69x89/169 Kg (372 lbs) | 125x69x89/171 Kg (376 lbs) | 125x69x89/173 Kg (381 lbs) |

PLUS



Built-in elastic joint for better pump/motor coupling



New CL 6.0 self-priming three-piston integral ceramic pump, tapered roller bearings, double oil viewer, nickel-plated brass head and high temperature water seals







New flanged pressure regulating valve L3.1, internal passages resized to ensure correct operation even in high operating flow conditions



Easily removable side panels and upper fairing for faster maintenance

STANDARD EQUIPMENT

| | | | | |
|--|--|--|--|--|
|  <ul style="list-style-type: none"> • 00080-01695 Gun M22 - 3/8 with rotating coupling |  <ul style="list-style-type: none"> • 00080-01727 Lance M22 high pressure. |  <ul style="list-style-type: none"> • 00080-03188 Nozzle type 045 (mod. 2015 LP) • 00080-03193 Nozzle type 070 (mod. 2021 LP) • 00080-03187 Nozzle type 040 (mod. 2515 LP) |  <ul style="list-style-type: none"> • 00080-02347 High pressure hose 10 m | |
|--|--|--|--|--|

OPTIONAL

| | | | | |
|--|---|---|--|--|
| <ul style="list-style-type: none"> • 10001-10198 - Hose reel with brake (hose not included) | <ul style="list-style-type: none"> • 00073-00114 - Antiscale LC-PRECAL (pz. 4 x 5 lt.) | <ul style="list-style-type: none"> • Turbo Lance code: 00080-02966 - (mod. 2015/2515) 00080-02968 - (mod. 2021) | <ul style="list-style-type: none"> • High pressure hose code: 00080-02258 10 m - 310 bar 00080-02261 20 m - 400 bar 00080-02264 10 m R2 00080-02262 20 m - 400 bar 00080-02263 10 m - 400 bar food industry | <ul style="list-style-type: none"> • Sandblasting lance code: 00080-02957 (mod. 2015/2515) 00080-02958 (mod. 2021) |
|--|---|---|--|--|

HMR



Motor with elastic joint

NEW

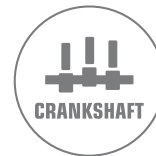

MORE INFO



CHARACTERISTICS

- Integrated elastic joint, for best pump coupling
- 4 poles professional electrical motor (1400 rpm)
- Triplex pump with three ceramic pistons, brass linear pump head
- Low voltage and delayed Total Stop
- Professional pressure unloader valve
- 25 Lt Diesel tank with level float
- High-pressure detergent suction with proportional detergent regulation
- 2 big solid wheels (Ø 260 mm) + 2 pivoting wheels with brake
- No fuel indicator
- Temperature setting thermostat
- Safety valve
- Pressure gauge
- Boiler thermal protection
- Contactor and motor protection with amperometric control
- Independent boiler ventilation unit
- Flame control (only mod. 2021)
- Single central bar for vertical lifting with crane or winches
- Steel frame, stainless steel cover
- On request available with stainless steel coil

TECHNICAL DATA

| | HMR 2015 LP | HMR 1521 LP | HMR 2021 LP |
|--------------------------|-----------------------------|-----------------------------|-----------------------------|
| code | 36034-00015 | 36034-00016 | 36034-00017 |
| rated/max pressure | 190/200 bar - 2755/2900 psi | 150/160 bar - 2175/2320 psi | 190/200 bar - 2755/2900 psi |
| max delivery flow rate | 900 l/h - 3.9 gpm | 1260 l/h - 5.55 gpm | 1260 l/h - 5.55 gpm |
| abs. power/supply | 6000 W/400V 3~50Hz | 6000 W/400V 3~50Hz | 6000 W/400V 3~50Hz |
| motor power | 5,5 kW | 5,5 kW | 7,5 kW |
| pump model | CL6.0/1400 rpm | CL6.0/1400 rpm | CL6.0/1400 rpm |
| T max water inlet/outlet | 60/110 °C | 60/110 °C | 60/110 °C |
| dimension (cm)/weight | 90x65x87/160 Kg (352 lbs) | 90x65x87/160 Kg (352 lbs) | 90x65x87/160 Kg (374 lbs) |

PLUS



Robust tubular frame in painted steel with central bar for lifting with crane or hoist, practical side hooks for accessories and protective top covers in stainless steel to preserve the motor pump from accidental shocks



Air chamber front wheels and two pivoting rear wheels for optimal stability and ease of movement on any type of surface







Widely oversized 4-pole industrial electric motor, protected from painting and equipped with elastic joint for better motor/pump coupling



Large 25-litre Diesel tank with level indicator and fuel shortage indicator light

STANDARD EQUIPMENT

| | | | | |
|--|---|--|--|--|
|  <ul style="list-style-type: none"> • 00080-01695 Gun M22 - 3/8 with rotating coupling |  <ul style="list-style-type: none"> • 10002-04732 Lance M22 high/low pressure |  <ul style="list-style-type: none"> • 00080-03247 nozzle 050 (mod. 2015) • 00080-03341 nozzle 075 (mod. 1521) • 00080-00303 nozzle 070 (mod. 2021) |  <ul style="list-style-type: none"> • 00014-00514 High pressure hose 10 m - R2 5/16 (mod. 2015) • 10002-03312 High pressure hose 10 m - R2 3/8 (mod. 1521/2021) | |
|--|---|--|--|--|

OPTIONAL

| | | | | |
|--|--|--|--|--|
| <ul style="list-style-type: none"> • Turbo lance code: 00080-02967 (mod. 2015) 00080-02968 (mod. 1521/2021) | <ul style="list-style-type: none"> • Sand-blasting lance code: 00080-02958 (mod. 2015) 00080-02959 (mod. 1521/2021) | <ul style="list-style-type: none"> • Hose reel (On request) | | |
|--|--|--|--|--|

HHPV



Motor with elastic joint

Only mod. 2015/2021

NEW



HOSE REEL WITH 20m H.P HOSE INCLUDED



MORE INFO



CHARACTERISTICS

- 4-pole electric industrial motor air cooled (1400 rpm) with thermal protection
- Integrated flexible coupling, for a better pump/motor coupling (mod 2015/2021)
- CL3.8 (mod 1212) CL6.0 (mod 2015/2021) pumps with brass head and three ceramic pistons, flanged valve (mod 2015/2021)
- Professional unloader valve with external by-pass
- Suction and delivery valves in stainless steel
- Low voltage delayed Total Stop
- High pressure detergent suction with solenoid valve
- 25 liter Diesel tank with level indicator and filter
- Vertical boiler with high thermal efficiency steel coil
- Control panel with protective cover
- General shutdown (when the machine is not used for a long time)
- Anti-limescale device with pump and tank (2.5 l) antifreeze heater and soundproof panel
- Microleak detector
- Accessory holder
- Burner activated by flow switch
- Internal insulating protection to resist high/low temperatures
- Hose reel with 20m h.p hose included
- **Antifreeze resistance**
- **Internal water tank with float level**
- **Flame control**

TECHNICAL DATA

| | HHPV 1212 LP | HHPV 2015 LP | HHPV 2021 LP |
|--------------------------|-----------------------------|-----------------------------|-----------------------------|
| code | 36075-00045 | 36075-00043 | 36075-00047 |
| rated/max pressure | 100/110 bar - 1450/1595 psi | 200/230 bar - 2900/3335 psi | 200/230 bar - 2900/3335 psi |
| max delivery flow rate | 720 l/h - 2.9 gpm | 900 l/h - 3.96 gpm | 1260 l/h - 5.55 gpm |
| abs. power/supply | 3000 W/230V 1~50Hz | 7300 W/400V 3~50Hz | 9700 W/400V 3~50Hz |
| motor power | 2,2 kW | 5,5 kW | 7,5 kW |
| electrical supply | - | 3P+T+N | 3P+T+N |
| pump model | CL3.8/1400 rpm | CL6.0/1400 rpm | CL6.0/1400 rpm |
| T max water inlet/outlet | 60/110 °C | 60/110 °C | 60/110 °C |
| dimension (cm)/weight | 76x48x190/190 Kg (418 lbs) | 76x48x190/200 Kg (440 lbs) | 76x48x190/210 Kg (462 lbs) |

PLUS



All the models are equipped with a stainless steel outlet with rain protection



Automatic hose reel kit with 20 meters of hose (standard on the versions 36075-00045 / 36075-00043 / 36075-00047) and hose guide to facilitate the unwinding and rolling of the hose during work



On request, versions with a structure entirely made of stainless steel are available







Easily removable panels and upper canopy for faster maintenance

Other available versions:

- 36075-00046 - HHPV 1212 without hose reel with 10m h.p hose
- 36075-00044 - HHPV 2015 without hose reel with 10m h.p hose
- 36075-00048 - HHPV 2021 without hose reel with 10m h.p hose

STANDARD EQUIPMENT

| | | | | |
|--|--|---|---|--|
|  <ul style="list-style-type: none"> • 00080-01695 Gun M22 - 3/8 with rotating coupling |  <ul style="list-style-type: none"> • 00080-01727 Lance M22 high pressure. |  <ul style="list-style-type: none"> • 00080-03189 Nozzle type 050 (mod. 1212) • 00080-03188 Nozzle type 045 (mod. 2015) • 00080-03193 Nozzle type 070 (mod. 2021) |  <ul style="list-style-type: none"> • 00014-00268 High pressure hose R2 20 m (mod. 2021) • 00080-02262 High pressure hose R2 20 m (mod. 1212/2015) | |
|--|--|---|---|--|

OPTIONAL

| | | | | |
|--|---|--|--|--|
| <ul style="list-style-type: none"> • Anti scale device (on request) | <ul style="list-style-type: none"> • Rotating booms (on request) | <ul style="list-style-type: none"> • High pressure hose code: 00080-02258 10 m - 310 bar 00080-02261 20 m - 400 bar 00080-02264 10 m R2 00080-02262 20 m - 400 bar 00080-02263 10 m - 400 bar food industry | <ul style="list-style-type: none"> • Turbo Lance code: 00080-02966 - (mod. 1211/2015) 00080-02968 - (mod. 2021) | <ul style="list-style-type: none"> • Sand-blasting lance code: 00080-02958 (mod. 1211/2015) 00080-02959 (mod. 2021) |
|--|---|--|--|--|

Thermic 10.1 HW Hot water self-contained unit

NEW



MORE INFO



CHARACTERISTICS

- Sturdy frame with rubber feet, bar for vertical lift
- Professional hot water high pressure cleaner for uses without connection to electricity grid
- Yanmar L100V Diesel engine (air cooled)
- Electrical starting-up, battery included
- No engine-oil safety device (oil-alert)
- Automatic decelerator to reduce rpm in by-pass mode
- 1560 rpm reducer between engine and pump
- CL6.0 Lavor linear pump, 3 ceramic pistons, brass pump head and flanged unloader valve with knob for pressure adjusting
- Diesel tank with level float and fill up filter
- Double coil vertical high efficiency boiler with stainless steel outer casing
- Electronic temperature setting system for constant water temperature
- Flow-switch operated burner
- Safety valve
- Boiler thermal protection
- Flame control kit

TECHNICAL DATA

| | Thermic 10.1 HW 1621 | Thermic 10.1 HW 2016 |
|--------------------------|-----------------------------|-----------------------------|
| code | 36111-00032 | 36111-00031 |
| rated/max pressure | 160/180 bar - 2320/2610 psi | 200/230 bar - 2900/3335 psi |
| max delivery flow rate | 1260 l/h - 5.5 gpm | 960 l/h - 4.1 gpm |
| engine type | Yanmar L100V | Yanmar L100V |
| motor power | 9,3 hp | 9,3 hp |
| pump model | CL6.0/1560 rpm | CL6.0/1560 rpm |
| T max water inlet/outlet | 60/110 °C | 60/110 °C |
| dimension (cm)/weight | 120x73x95/200 Kg (440 lbs) | 120x73x95/200 Kg (440 lbs) |

PLUS



Sturdy painted steel frame with bar for lifting with crane or hoist, practical side hooks for accessories and protective stainless steel covers to preserve the motor pump from accidental impacts



Engine indicator panel with electric start, automatic regulation of the number of revolutions, boiler panel with burner activation switch and electronic temperature regulation



Yanmar L100V diesel engine, electric start panel with control lights, automatic rev decelerator



Flame control: stops hot water operation in the event of a burner malfunction, blocking the diesel solenoid valve and avoiding fouling of the unburned fuel boiler. It also prevents the flame from remaining lit even when the burner is already extinguished.

STANDARD EQUIPMENT

| | | | | |
|---|---|---|--|--|
|  <ul style="list-style-type: none"> • 00080-01695 Gun M22 - 3/8 with rotating coupling |  <ul style="list-style-type: none"> • 10002-04732 Lance M22 high/low pressure |  <ul style="list-style-type: none"> • 00080-03247 nozzle 050 (mod. 2016) • 00080-03341 nozzle 075 (mod. 1621) |  <ul style="list-style-type: none"> • 00014-00514 High pressure hose 10 m - R2 5/16 (mod. 2016) • 10002-04109 High pressure hose 10 m - R2 3/8 (mod. 1621) |  <ul style="list-style-type: none"> • Flame control |
|  <ul style="list-style-type: none"> • RPM decelerator kit | | | | |

OPTIONAL

| | | | | |
|--|--|---|---|--|
| <ul style="list-style-type: none"> • 10002-04739 Turbo lance 255 bar 050 (mod. 2016) • 10002-04741 Turbo lance 255 bar 070 (mod. 1621) | <ul style="list-style-type: none"> • 00080-02258 Extension hose 10 m • 00080-02262 Extension hose 20 m | <ul style="list-style-type: none"> • 00080-02958 Sand blasting lance | <ul style="list-style-type: none"> • 10001-00983 Wheel kit | <ul style="list-style-type: none"> • 10001-01014 Soundproofing kit (on request) |
| <ul style="list-style-type: none"> • 00080-01503 Hose reel with hose 20m | | | | |

Thermic 26 HW

NEW



MORE INFO



CHARACTERISTICS

- Professional hot pressure washer for use without connection to the electricity mains
- 45 lt Diesel tank with level float and filling filter
- High efficiency vertical stainless steel boiler with double spiral coil
- Electronic temperature regulation system with low value oscillation
- Burner activated by flow switch
- Safety valve
- Boiler thermal protection
- Flame control kit
- Kohler KDW1003 Diesel engine
- TW / RW Premium pumps
- Speed reducer (with 1450 rpm)
- Electric start
- Low oil safety device engine
- Hour meter
- Manual speed regulator
- Professional adjustment valve with gradual pressure recovery
- Thermostatic valve
- Large size inlet water filter with inspectable cartridge pump
- Option of water suction from external tank
- Suitable for highly professional use

TECHNICAL DATA

| | Thermic 26 HW 2523 | Thermic 26 HW 3518 | Thermic 26 HW 2030 |
|--------------------------|-----------------------------|-----------------------------|-----------------------------|
| code | 36033-00013 | 36033-00014 | 36033-00015 |
| rated/max pressure | 250/275 bar - 3625/3988 psi | 350/375 bar - 5076/5438 psi | 200/210 bar - 2900/3045 psi |
| max delivery flow rate | 1380 l/h - 6 gpm | 1140 l/h - 5.0 gpm | 1800 l/h - 7.9 gpm |
| engine type | KDW 1003 | KDW 1003 | KDW 1003 |
| motor power | 26 hp | 26 hp | 26 hp |
| T max water inlet/outlet | 60/110° | 60/110° | 60/110° |
| dimension (cm)/weight | 125x85x105/450 Kg (992 lbs) | 125x85x105/450 Kg (992 lbs) | 125x85x105/450 Kg (992 lbs) |

PLUS



Engine indicator light panel with electric start, hour counter and manual adjustment of the number of revolutions, boiler panel with burner activation switch and electronic temperature regulation



Kohler KDW 1003 water-cooled engine, 3 cylinders in line to minimise vibrations





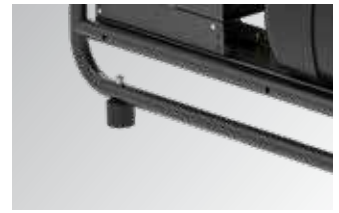

RW/TW Premium self-priming three-piston pumps in integral ceramic, tapered roller bearings, double oil viewer and brass head



Sturdy painted steel frame with vertical lifting bar, practical side hooks for accessories and protective stainless steel covers to preserve the motor pump from accidental impacts

STANDARD EQUIPMENT

| | | | | |
|---|---|--|--|--|
|  <ul style="list-style-type: none"> • 00080-01097 Gun ML 955 - M22 with quick coupling (mod. 2523/2030) • 00080-01098 Gun ML 955 - M24 with quick coupling (mod. 3518) |  <ul style="list-style-type: none"> • 10002-04019 lance SF40 mecline M22 (mod.2523/2030) • 10002-04020 lance SF40 mecline M24 (mod.3518) |  <ul style="list-style-type: none"> • 00080-01368 Nozzle type 040 (mod. 3518) • 00080-00359 Nozzle type 055 (mod. 2523) • 00080-03339 Nozzle type 2510 (mod. 2030) |  <ul style="list-style-type: none"> • 10002-04109 High pressure hose 10 m (mod.2523/2030) • 10002-04110 High pressure hose 10 m (mod.3518) | |
|---|---|--|--|--|

OPTIONAL

| | | | | |
|--|--|---|--|--|
| <ul style="list-style-type: none"> • Turbo lance (on request) | <ul style="list-style-type: none"> • Hose reel (on request) | <ul style="list-style-type: none"> • Pipe cleaning hose (on request) | | |
|--|--|---|--|--|

Vulcano 74



MORE INFO



CHARACTERISTICS

Boiler feeding: Diesel High thermal efficiency vertical burner. • Shock-resistant self-bearing frame. • 4 big wheels for easy move. • Gasoil tank high capacity ensuring longer working. • Quick couplings supplied with the machine. • Diesel tank capacity 18 l. • High pressure hose 3/8" Ø 5/16" 10 m, to connect any cold high pressure cleaner to Vulcano (**optional**).

TECHNICAL DATA

| | Vulcano 74 |
|--------------------------|-----------------------------|
| code | 38003-00001 |
| rated/max pressure | 120/200 bar - 1740/2900 psi |
| max delivery flow rate | 1260 l/h - 5.55 gpm |
| abs. power/supply | 300 W/230V 1~50Hz |
| heat output | 74 kW |
| T max water inlet/outlet | 110/ °C |
| dimension (cm)/weight | 94x65x90/44 Kg (88 lbs) |

PLUS

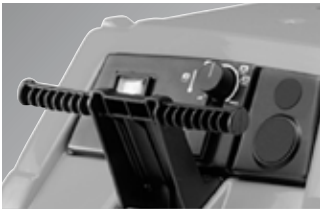

Simple and intuitive control panel, with switch and temperature regulation thermostat



High-efficiency diesel vertical boiler with steel coil (stainless steel on request)



Easily connected to all LAVOR cold water high pressure cleaners for hot water generation



4 twinned solid wheels to facilitate movement on any type of surface

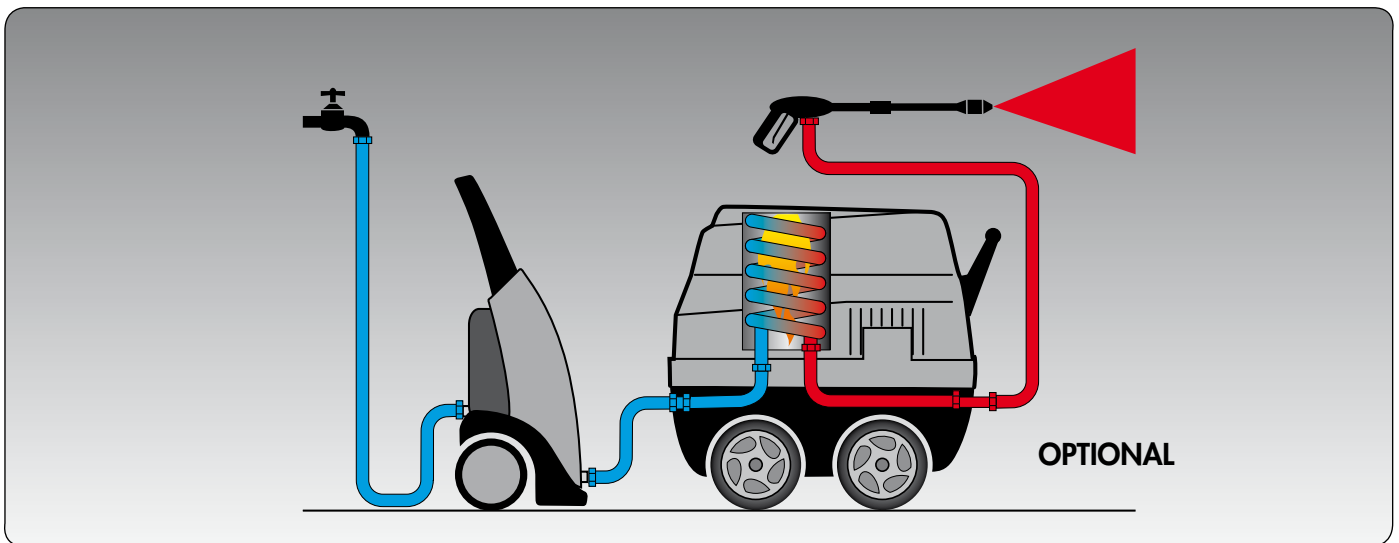

OPTIONAL

| | | | | |
|---|--|--|--|--|
| <p>• 00080-02258 high pressure hose 3/8" ø 5/16" 10m, to connect any cold high pressure cleaner to the Vulcano.</p> | | | | |
|---|--|--|--|--|

High-pressure nozzle



| | |
|-------------|---------------------------|
| 00080-03167 | high-pressure nozzle 0.30 |
| 00080-03176 | high-pressure nozzle 0.35 |
| 00080-03168 | high-pressure nozzle 0.40 |
| 00080-03173 | high-pressure nozzle 0.45 |
| 00080-03169 | high-pressure nozzle 0.50 |
| 00080-03170 | high-pressure nozzle 0.55 |
| 00080-03171 | high-pressure nozzle 0.60 |
| 00080-03165 | high-pressure nozzle 0.70 |
| 00080-03207 | high-pressure nozzle 0.75 |
| 00080-03172 | high-pressure nozzle 0.90 |

| | |
|-------------|---------------------------|
| 00080-03185 | high-pressure nozzle 0.30 |
| 00080-03186 | high-pressure nozzle 0.35 |
| 00080-03187 | high-pressure nozzle 0.40 |
| 00080-03188 | high-pressure nozzle 0.45 |
| 00080-03189 | high-pressure nozzle 0.50 |
| 00080-03190 | high-pressure nozzle 0.55 |
| 00080-03191 | high-pressure nozzle 0.60 |
| 00080-03193 | high-pressure nozzle 0.70 |
| 00080-03194 | high-pressure nozzle 0.75 |
| 00080-03196 | high-pressure nozzle 0.85 |

| | |
|-------------|---------------------------|
| 00080-03159 | high-pressure nozzle 0.30 |
| 00080-03161 | high-pressure nozzle 0.35 |
| 00080-03153 | high-pressure nozzle 0.40 |
| 00080-03157 | high-pressure nozzle 0.45 |
| 00080-03158 | high-pressure nozzle 0.50 |
| 00080-03160 | high-pressure nozzle 0.55 |
| 00080-03162 | high-pressure nozzle 0.60 |
| 00080-03204 | high-pressure nozzle 0.70 |
| 00080-03205 | high-pressure nozzle 0.75 |
| 00080-03206 | high-pressure nozzle 0.90 |



Turbo nozzle 280

Turbo nozzle 280 bar:
G 1/4" F brass

Extension for turbo nozzle:
1/4" M - 1/4" M code 00009-03342
+ coupling for gun M22 code 00009-03220

| | |
|-------------|---------------------|
| 10001-10226 | turbo nozzle - 0.45 |
| 10001-10250 | turbo nozzle - 0.55 |
| 00080-03477 | turbo nozzle - 0.70 |



Turbo nozzle 350/400

Turbo nozzle 350/400 bar:
G 1/4" F brass

| | |
|-------------|---------------------------------|
| 00080-03419 | turbo nozzle max 350 bar - 0.45 |
| 00080-03420 | turbo nozzle max 350 bar - 0.55 |
| 00080-03416 | turbo nozzle max 400 bar - 0.40 |
| 00080-03421 | turbo nozzle max 400 bar - 0.45 |
| 00080-03422 | turbo nozzle max 400 bar - 0.55 |
| 00080-03423 | turbo nozzle max 600 bar - 0.45 |
| 00080-03424 | turbo nozzle max 600 bar - 0.65 |



Turbo nozzle 600

Turbo nozzle max 600 bar:
G 1/4" F stainless steel

Extension for turbo nozzle:
1/4" M - 1/4" M code 00009-03342
+ coupling for gun M22 code 00009-03220



| | |
|-------------|----------------------------------|
| 00080-03444 | rotary nozzle max 500 bar - 0.40 |
| 00080-03445 | rotary nozzle max 500 bar - 0.45 |
| 00080-03446 | rotary nozzle max 500 bar - 0.50 |
| 00080-03447 | rotary nozzle max 500 bar - 0.55 |
| 00080-03448 | rotary nozzle max 500 bar - 0.60 |
| 00080-03449 | rotary nozzle max 500 bar - 0.65 |
| 00080-03450 | rotary nozzle max 500 bar - 0.70 |
| 00080-03416 | rotary nozzle max 350 bar - 0.40 |

Rotary head nozzle

Rotary nozzle max 350/500 bar:
G 1/4" F with Stainless steel body and seat/
nozzle in highly shock-resistant tungsten
carbide

Extension set for rotary nozzle:
1/4" M - 1/4" M codes 00009-03342 +
00009-03220 Spare coupling for gun M 22



1) Sand-blasting heads max 250 bar, **are not**
supplied with nozzles.
Orders will be always placed with the nozzle required.

Sand-blasting heads max 250 bar

| | |
|-------------|-------------------------------------|
| 00080-03451 | Sand blasting head - blade type |
| 00080-03452 | Sand blasting head - round type |
| 00080-03453 | Sand blasting head - prolonged type |

Sand-blasting head

Sand-blasting nozzles

| | |
|-------------|-------------|
| 00080-03473 | nozzle 0.40 |
| 00080-03472 | nozzle 0.45 |
| 00080-03471 | nozzle 0.50 |



2) Prolonged adjustable probe for sand-blasting

| | |
|-------------|--|
| 00069-00364 | Stainless steel prolonged adjustable Ø 21 probe L = 500 mm |
|-------------|--|



Magnetic Antiscale Stainless steel

The magnetic antiscalant is a method that reduces the negative effects caused by high water hardness through the action of a magnetic field, offering itself as a non-chemical alternative for water softening.

Magnetic Antiscale Stainless steel 3/4 F - 3/4 M

| | |
|-------------|------------------------------------|
| 00069-00217 | Magnetic antiscalant 3/4 F - 3/4 M |
|-------------|------------------------------------|

Gun with extensible telescopic lance

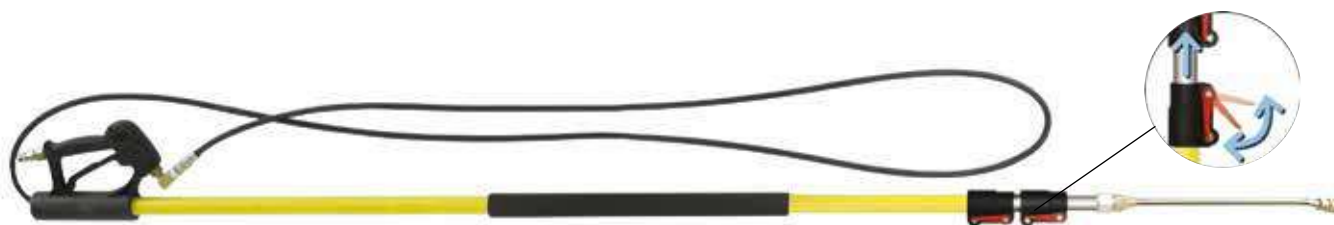

Adapters are required to connect the gun to a 3/8" hose cod. 10001-10196 + 00009-03156

With coupling for quick coupling nozzle (without nozzle)



| Code | Pressure | | Flow rate l/m | Lenght | | Coupling A | Temperature °C | |
|-------------|----------|------|------------------|--------|---------|---------------|-------------------|---------|
| | bar | psi | | MPa | min. mm | | | max. mm |
| 00080-01744 | 250 | 3625 | 25 | 30 | 198 | 549 | fast | 150 |



10001-08032 Belt support for telescopic lance



00080-01745 Curved lance set for gutters washing



| Code | Description | Hole |
|-------------|--|------|
| 00080-03425 | Quick coupling ceramic nozzle 15° | 035 |
| 00080-03426 | Quick coupling ceramic nozzle 15° | 04 |
| 00080-03427 | Quick coupling ceramic nozzle 15° | 045 |
| 00080-03428 | Quick coupling ceramic nozzle 15° | 05 |
| 00080-03429 | Quick coupling ceramic nozzle 15° | 055 |

High pressure inox lance



| Code | Description |
|-------------|---|
| 00080-03972 | lance with nozzle holder 310 bar INOX 900 mm (without nozzle) M22-1/4" F |
| 00080-03973 | lance with nozzle holder 310 bar INOX 1200 mm (without nozzle) M22-1/4" F |

High-pressure cleaner with combustion engine accessories

High pressure hose



| | | |
|---------------------|---|-------------|
| | 10 m High pressure hose - 3/8" - Ø 5/16" - 310 bar | 00080-02258 |
| | 20 m High pressure hose - 3/8" - Ø 5/16" - 400 bar | 00080-02261 |
| | 20 m High pressure hose - 3/8" - Ø 3/8" - 400 bar | 00080-02262 |
| | 10 m High pressure hose for food industry - 3/8" - Ø 3/8" - 400 bar | 00080-02263 |
| | 10 m High pressure hose - 3/8" F - Ø 3/8" R2 | 00080-02264 |
| | 20 m Extension high pressure hose | 10002-04098 |
| | 20 m Extension high pressure hose | 10002-04099 |
| | 10 m Extension high pressure hose | 10002-04106 |
| THERMIC 5H | | |
| THERMIC 6,5 | | |
| THERMIC 9 L | • • | |
| THERMIC 10 D | ▲ ▲ ▲ ▲ | |
| THERMIC 2W PRO 13 L | | |
| THERMIC 2W PRO 13 H | | |
| THERMIC 11 H/11 HF | ▲ ▲ ▲ ▲ | |
| THERMIC 13 H/13 HF | ▲ ▲ ▲ ▲ | |
| THERMIC 18 3518 BS | | |
| THERMIC 22 3521 H | | |
| THERMIC 22 4018 H | | • |
| THERMIC 22 5015 H | | • |
| THERMIC 26 3523 K | | • |
| THERMIC 26 4020 K | | • |
| THERMIC 26 5016 K | | • |
| THERMIC 10.1 HW | ▲ ▲ ▲ ▲ | |
| THERMIC 17 HW | ▲ ▲ ▲ ▲ | |
| THERMIC 22 2730 | | • |
| THERMIC 31 7015 | | |
| THERMIC 26 7013 | | |

• = Suitable ▲ = Suitable (with adapter 00009-02101)

Turbo lance



| | | |
|---------------------|-------------------------------|-------------|
| | Lance Turbo type 1 M22 - 0,45 | 00080-02966 |
| | Lance Turbo type 2 M22 - 0,55 | 00080-02967 |
| | Lance Turbo type 3 M22 - 0,70 | 00080-02968 |
| | Lance Turbo M22 - 0,35 | 00080-02981 |
| | Lance Turbo | 10002-03408 |
| | Lance Turbo | 10002-04097 |
| | Lance Turbo | 10002-04096 |
| | Lance Turbo | 10002-04094 |
| | Lance Turbo | 10002-04104 |
| | Lance Turbo | 10002-04150 |
| THERMIC 5H | | • |
| THERMIC 6,5 | | • |
| THERMIC 9 L | • | |
| THERMIC 10 D | • | |
| THERMIC 2W PRO 13 L | | |
| THERMIC 2W PRO 13 H | | • |
| THERMIC 11 H/11 HF | | • |
| THERMIC 13 H/13 HF | • | |
| THERMIC 18 3518 BS | | |
| THERMIC 22 3521 H | | |
| THERMIC 22 4018 H | | • |
| THERMIC 22 5015 H | | • |
| THERMIC 26 3523 K | | • |
| THERMIC 26 4020 K | | • |
| THERMIC 26 5016 K | | • |
| THERMIC 10.1 HW | • | |
| THERMIC 17 HW | • | |
| THERMIC 22 2730 | | • |
| THERMIC 31 7015 | | |
| THERMIC 26 7013 | | |

Sand blasting lance



| | | |
|---------------------|--------------------------------------|-------------|
| | Wifia sand-blasting lance M22 - 0,40 | 00080-02957 |
| | Wifia sand-blasting lance M22 - 0,50 | 00080-02958 |
| | Wifia sand-blasting lance M22 - 0,75 | 00080-02959 |
| | Sand-blasting lance | 10002-04102 |
| | Sand-blasting lance | 10002-04101 |
| | Sand-blasting lance | 10002-04100 |
| | Sand-blasting lance | 00058-00650 |
| THERMIC 5H | • | |
| THERMIC 6,5 | | |
| THERMIC 9 L | • | |
| THERMIC 10 D | | |
| THERMIC 2W PRO 13 L | | • |
| THERMIC 2W PRO 13 H | | |
| THERMIC 11 H/11 HF | | • |
| THERMIC 13 H/13 HF | • | |
| THERMIC 18 3518 BS | | |
| THERMIC 22 3521 H | | • |
| THERMIC 22 4018 H | | • |
| THERMIC 22 5015 H | | • |
| THERMIC 26 3523 K | | |
| THERMIC 26 4020 K | | |
| THERMIC 26 5016 K | | |
| THERMIC 10.1 HW | • | |
| THERMIC 17 HW | • | |
| THERMIC 22 2730 | | • |
| THERMIC 31 7015 | | |
| THERMIC 26 7013 | | |

Adapters for high pressure hoses

3/8" M 3/8" M



Code: 00009-03156

3/8" M M 22



Code: 00009-02848

1/4" M M 22

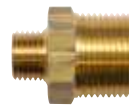

Code: 00009-02575

3/8" M M 22 F



Code: 00009-02101

Quick coupling kit hose/gun



Quick coupling kit hose/gun - brass - inlet 3/8" F - outlet 3/8" M - 200 bar
Code: 10001-10196



Quick coupling kit hose/gun - brass - inlet 1/4" F - outlet 1/4" M - 200 bar
Code: 10001-10195



Quick coupling kit hose/gun - inlet 3/8" F - outlet 3/8" M - 250 bar
Code: 10001-09948



Accessories High-pressure cleaners



| Code | Description |
|-------------|--|
| 00080-01691 | Gun RL 30 3/8"M - 1/4"F (only for lance 00080-02975 - 00080-02976) |
| 00080-02975 | mm 1700 Stainless steel 1/4"M - 1/8"F high/low press. (for det. suction) for gun 00080-01691 |
| 00080-02976 | mm 1700 Stainless steel 1/4"M - 1/8"F lance with nozzle-holder - for gun 00080-01691 |

Food industry high pressure accessories

For food industry



| Code | Description |
|-------------|--|
| 00080-01688 | Gun RL 30 3/8"F - M 24"F |
| 00080-01717 | mm 1050 Stainless steel - M24"M - 1/8"F lance with nozzle-holder (nozzle not included) |
| 00080-02263 | 10 m H. P. Hose - 400 bar 3/8"F - 3/8"F - Ø 3/8" - max 150° C- R2 |



Steam hose R2 with rubber hose bend Ø 3/8"

For food industry

| Code | Max. pressure | | | Length m | Inlet | Outlet | Max. temperature °C |
|-------------|---------------|------|-----|-------------|-------|--------|------------------------|
| | bar | psi | MPa | | | | |
| 00080-02264 | 400 | 5801 | 40 | 10 | 3/8"F | 3/8"F | 135 |



Wall mount hose reel

Wall mount hose reel with brakets without hose (capability 20 m hose 3/8")

| Code | Description | Inlet | Outlet |
|-------------|--|-------|--------|
| 10001-10252 | Wall mount hose reel with brakets without hose | 3/8"F | 3/8"F |



Automatic hose reel

Automatic hose reel (capability 20 m hose)

| Code | Description | Inlet | Outlet |
|-------------|--|-------|--------|
| 00080-03964 | Varnished steel automatic hose reel | 3/8"M | 3/8"F |
| 00080-03966 | Stainless steel automatic hose reel | 3/8"M | 3/8"F |
| 00080-03965 | Varnished steel automatic hose reel with 20mt hose | 3/8"F | 3/8"F |



Double lance

Double lance mm 500 with regulator knob max 250 bar
Double lance mm 500 with regulator knob max 250 bar with nozzle holder

00080-01722 Double lance with regulator mm 500



Foam lance

Foam lance max 250 bar
Foam lance max temperature 90° C.
For gun M 22 max 250 bar

00080-02942 Foam lance

00080-02945 Foam lance with tank 1 lt.



Foam lance with regulator

Foam lance with regulator max 180 bar
Foam lance with regulator max temp. 60° C - with M22 coupling

00080-02980 Foam lance



Foam lance with regulator

Foam lance max 180 bar with tank 1 lt.
Foam lance with regulator max temp. 60° C - with M22 coupling

00080-02980 Foam lance with tank 1 lt.



Water filter
Water filter - 3/4 F - 3/4 M
80 micron

Water filter 3/4 F - 3/4 M

00070-00479 Water filter



Water filter
Water filter - G 1/2 F - G 1/2 F

Water filter G 1/2 F - G 1/2 F

00070-00374 Plastic water filter

00070-00095 Cartridge



Calibrated sand
Calibrated sand - 1 piece of 5 kg

Calibrated sand

00075-00005 Calibrated sand (1 x 5 kg)

Motorized head



for Thermic 13H
and Thermic 17 HW
in combination with M24 nipple
cod. 00009-03218



- Stainless steel motorized head for case and tank cleaning
- Complete orbital internal coverage
- Complete with nozzles and converter

| Motorized head | |
|-----------------------|---------------------|
| code | 00080-03443 |
| operat. pressure | 220 bar - 3190 psi |
| allowed pressure | 250 bar - 3625 psi |
| operat. delivery rate | 1260 l/h - 5,56 GPM |
| nominal temperature | 90° C |
| min. diameter | Ø 40 mm |
| nozzle type | 2 x M4 |

Floor Cleaning Lance



**Ø 510 mm
INOX**

- Stainless steel floor cleaning lance (nozzle not included)
- Complete with RL 35 gun
- For washing terraces and external floors in general.

| Floor Cleaning Lance 510 | |
|--------------------------|--------------------|
| code | 00080-04580 |
| operat. pressure | 250 bar - 3625 psi |
| allowed pressure | 280 bar - 4060 psi |
| operat. delivery rate | 1800 l/h - 5,3 GPM |
| nominal temperature | 82° C |

for Thermic 13H and Thermic 17 HW in combination with M24 nipple cod. 00009-03218

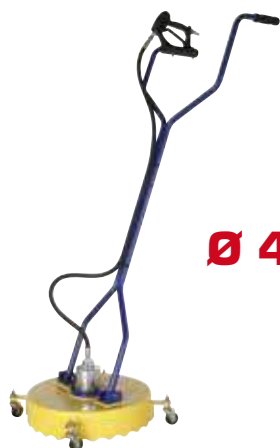

Ø 460 mm

- Heavy duty polypropylene floor cleaning lance (nozzle not included)
- Complete with RL 35 gun
- For washing terraces and external floors in general.

| Floor Cleaning Lance 460 | |
|--------------------------|--------------------|
| code | 00080-05164 |
| operat. pressure | 250 bar - 3625 psi |
| allowed pressure | 280 bar - 4060 psi |
| operat. delivery rate | 2400 l/h - 7 GPM |
| nominal temperature | 82° C |

for Thermic 13H and Thermic 17 HW in combination with M24 nipple cod. 00009-03218

Pipe cleaning nozzles

| | Code | Description | Thread | Type |
|--|-------------|--------------------------------------|--------|------|
| | 00080-03174 | Pipe cleaning nozzle with side holes | 3/8" M | 0.55 |
| | 00080-03242 | Rounded head pipe cleaning nozzle | 3/8" M | 0.55 |
| | 00080-03243 | Pipe cleaning nozzle with side holes | 3/8" F | 0.55 |
| | 00080-03255 | Pipe cleaning nozzle with side holes | 1/4" F | 0.55 |



Kit pipe cleaning hose with nozzle

| Code | Description | Length | Max. pressure | | | Inlet | Outlet |
|-------------|------------------------|--------|---------------|------|-----|----------|------------------------|
| | | | m | bar | psi | | |
| 10001-10239 | Kit pipe cleaning hose | 10 | 210 | 3045 | 21 | M 22 - M | Stainless steel nozzle |
| 10001-10231 | Kit pipe cleaning hose | 20 | 210 | 3045 | 21 | M 22 - M | Stainless steel nozzle |

Fixed and rotating brushes

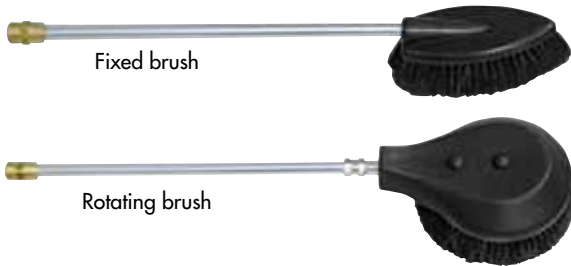

Fixed and rotating brushes max 250 bar: mm 700, max temperature 90° C, for gun M 22

00080-04389 Fixed brush with extension pipe mm 700

00080-04390 Rotating brush with extension pipe mm 700

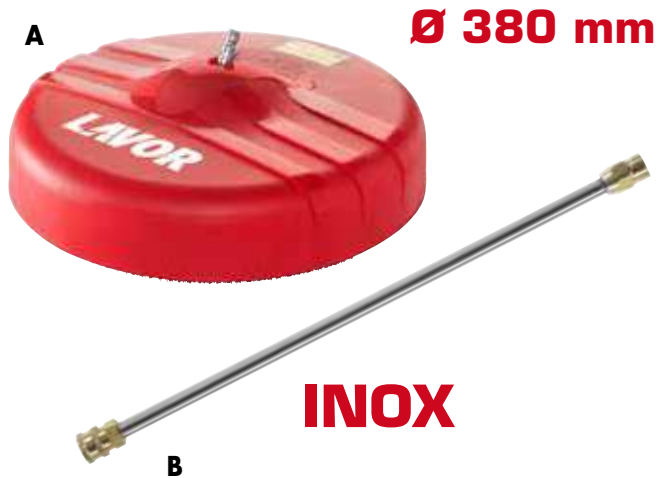

Floor Cleaning Lance for gun M 22

A - Patio cleaner L 38

| Code | Pressure | | Flow rate | | Inlet | Weight | Temperature | |
|-------------|----------|------|-----------|-----|-------|--------|-------------|-----|
| | bar | psi | l/h | GPM | | | °C | °F |
| 00080-04221 | 200 | 1900 | 680 | 3 | AR1 | 1,6 | 60 | 140 |

B - Stainless steel extension

| Code | Inlet | Outlet | Length | Weight |
|-------------|-----------|--------|--------|--------|
| 00080-04041 | M22x1,5 M | AR1 | 500 mm | 350 g. |

Professional surface cleaner lances for guns with M22 connection



Patio cleaner 355 x355 mm

| Code | Pressure | | Flow rate | | Inlet | Weight | Temperature | |
|-------------|----------|------|-----------|-----|-------|--------|-------------|-----|
| | bar | psi | l/h | GPM | | | °C | °F |
| 00080-04070 | 200 | 1900 | 900 | 4 | M22 | 3,62 | 60 | 140 |

More than 45 years of constructive experience...

Lavor offers a comprehensive range of pumps and motor pumps constructed and designed to meet any requirement of the market, providing a long-lasting and reliable solution to address cleaning needs...

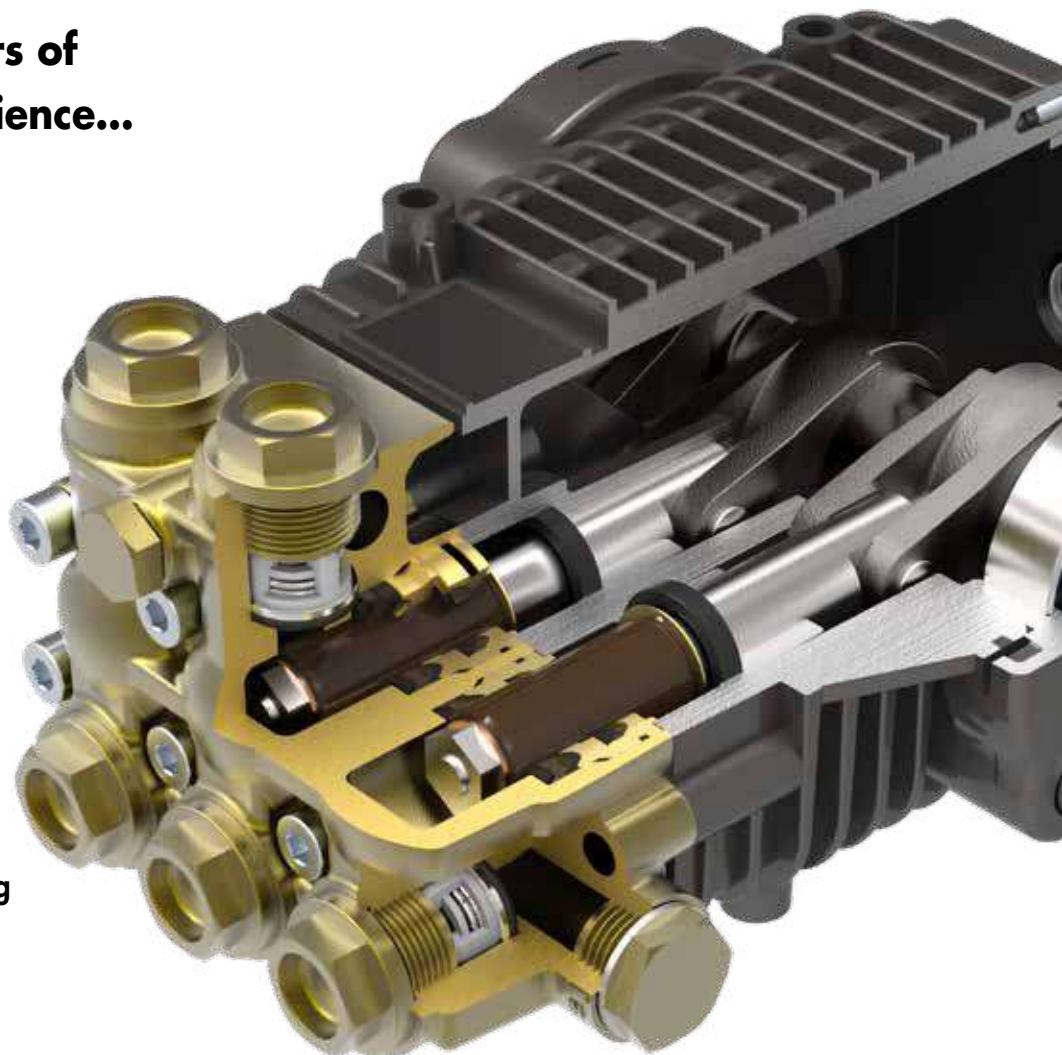

No compromises!

Lavor offering of pumps and motor pumps intentionally targets a clientèle seeking top quality and durability for this kind of products:

- 4-pole motors: They assure 1 400 RPM speed, resulting in a decrease of pump and motor's operating temperatures, reduction in wear of consumables, lower oil deterioration inside the pump.
- Water cooled motors: Enhanced effectiveness and lower operating temperatures translate into compact sizes and high performance.
- Elastic coupling: it assures better alignment, dissipation of the heat from the motor rotor, lower stress on bearings, easy disassembly of the pump from the motor.
- Pump body in die cast aluminium: the casing design focuses on assuring stress is reduced to

the minimum and operating temperatures are reduced, with the aim of guaranteeing unlimited service life.

- Forged brass pump head: improved mechanical strength, superior resistance to corrosion and oxidation phenomena.
- Nickel plated forged brass (CW6) pump head: the perfect surface finish, jointly with the properties of the plating, assure improved resistance to chemicals and lower chance of deterioration caused by cavitation phenomena.
- Double gasket seal system the choice of the "U" gasket profile represents the maximum quality standard, assuring lower wear due to friction.
- High temperature seals (CW6): They assure optimal durability up to 85° operation.
- Valves with stainless steel plate and spherical seal: high fluid dynamics performance.
- Ceramic pistons (according to the models): to assure longer service life of the pistons and guarantee lower wear of water seals and improved resistance to thermal shocks.
- Double housing connecting rods (CL6-CW 6): ease of maintenance.
- **"READY TO USE"** pumps (CL3.5): This range provides built-in by-pass valve, low pressure detergent injector, total stop actuation micro-switch, pressure regulation and pressure gauge, making installation easier and speeding up replacement and maintenance operations.

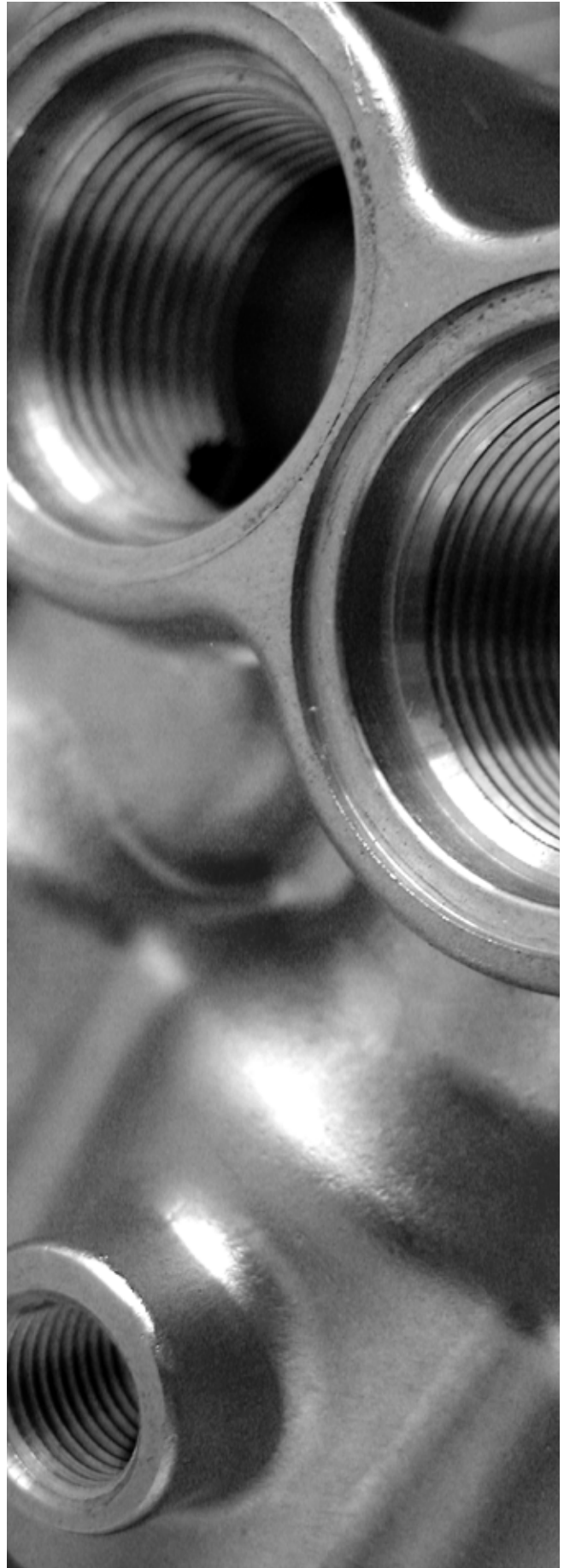

Pumps and electropumps

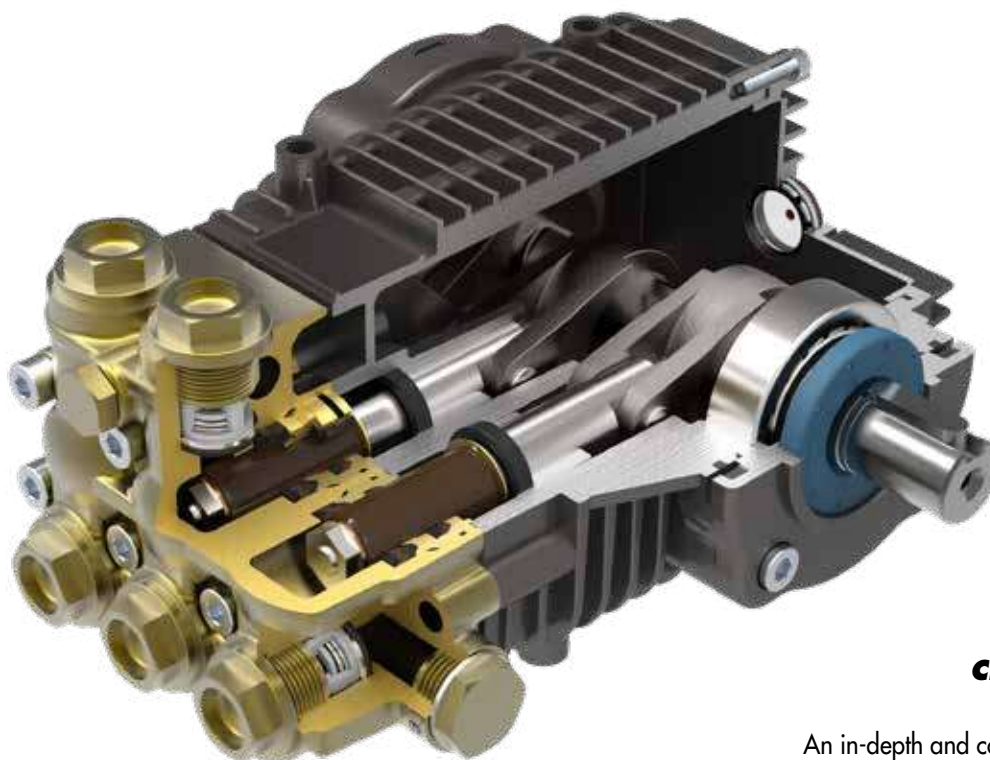

CL6 21-200

An in-depth and comparative study on each structural element • Low wear and tear ceramic pistons • Low friction connecting rod, built in aluminium alloy; double body for easy disassembly

- Minimum charge on the cone-shaped bearings (through electronic calibration of the drive shaft rotation)
- Very low operating temperature, favored by the use of water cooled motor • Top range up to 21 l/min.

| Model | Omnia 12 | Omnia 15 | CL3 | CL3.5 | CL6 | CW6 |
|------------------------|--------------------|--------------------|-------------------------------|-------------------------------|---------------------------------|---------------------------------|
| Pump type | Axial | Axial | Linear | Linear | Linear | Linear |
| Head | Brass | Brass | Brass | Brass | Brass | Brass nickel plated |
| Pistons | Stainless steel | Ceramic coated | Ceramic coated | Ceramic | Ceramic | Ceramic |
| Pistons Ø | 12 mm | 15 mm | 15 mm | 18 mm | 20 mm | 20 mm |
| By-pass valve | Integrated | Integrated | Integrated | Integrated | Separated | Separated |
| Pressure regulator | Integrated | Integrated | Integrated | Integrated | On by-pass | On by-pass |
| Max operating pressure | 140 bar | 200 bar | 200 bar | 200 bar | 200 bar | 200 bar |
| Max delivery rate | 9 l/min | 13 l/min | 13 l/min | 17 l/min | 21 l/min | 21 l/min |
| Motor | 2 poles air cooled | 2 poles air cooled | 4 poles air/ H ₂ O | 4 poles air/ H ₂ O | 4 poles H ₂ O cooled | 4 poles H ₂ O cooled |
| Total Stop | Available | Available | Available | Available | Available | Available |

MPBX1 series
(Omnia 12 Pump)

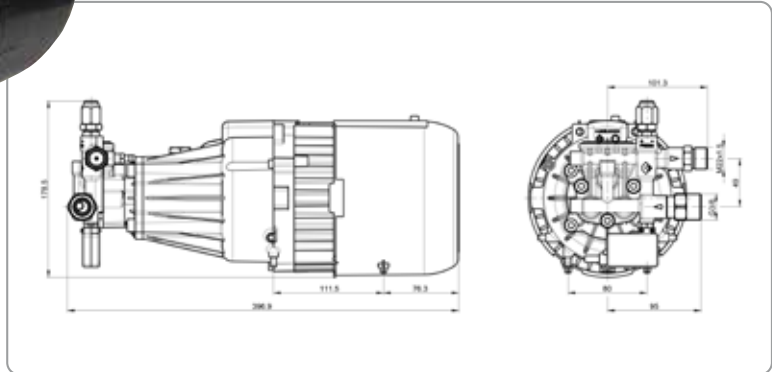
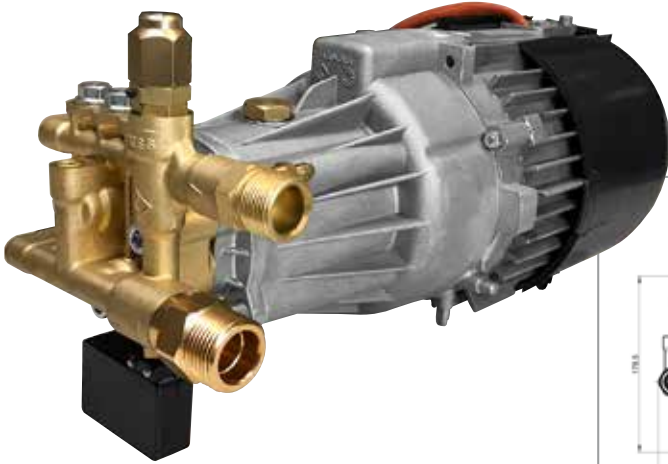

Equipped with:

- High-pressure motor pumps units
- Fixing bracket included

| Model | Left shaft ver. Code | RPM | Max. pressure | | | Flow rate | | Requested power kW | Power supply | Weight | |
|-----------------|-------------------------|------|---------------|------|-----|-----------|------|-----------------------|----------------|--------|------|
| | | | bar | psi | MPa | l/m | GPM | | | kg | lbs |
| MPBX 1-12 9-140 | on request | 2800 | 140 | 2030 | 14 | 9 | 2.37 | 2.8 | 1 Ph 230V~50Hz | 13 | 28,6 |
| MPBX 1-12 9-140 | on request | 3400 | 140 | 2030 | 14 | 9 | 2.37 | 2.8 | 1 Ph 220V~60Hz | 13 | 28,6 |

MPBX2 series
(Omnia 15 Pump)

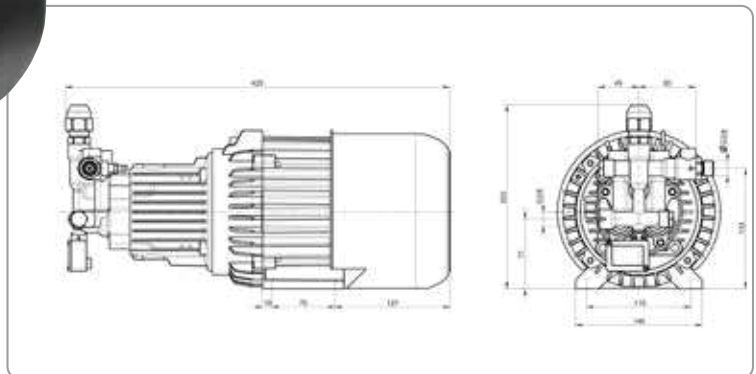
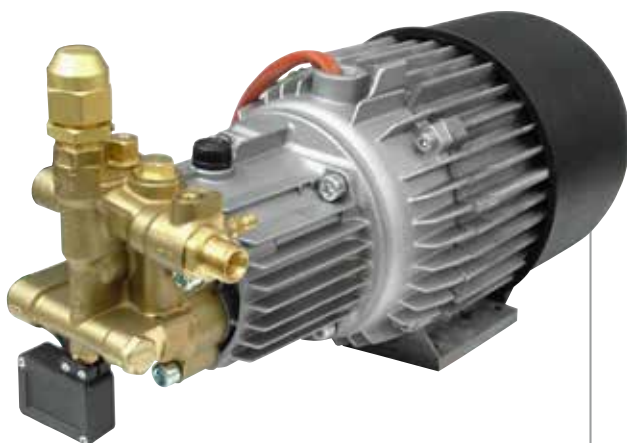

Equipped with:

- High-pressure motor pumps units
- Fixing bracket included

| Model | Left shaft ver. Code | RPM | Max. pressure | | | Flow rate | | Requested power kW | Power supply | Weight | |
|------------------|-------------------------|------|---------------|------|-----|-----------|-----|-----------------------|---------------|--------|------|
| | | | bar | psi | MPa | l/m | GPM | | | kg | lbs |
| MPBX 2-15 13-180 | on request | 2800 | 180 | 2610 | 18 | 13 | 3.4 | 4 | 3Ph 400V~50Hz | 21 | 46,2 |

MP3 series

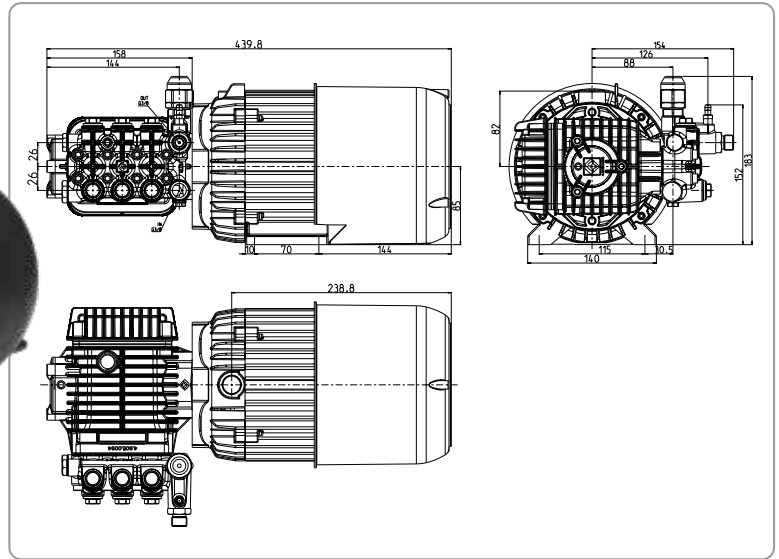

Equipped with:

- Pressure adjuster included

| Model | Left shaft ver. Code | RPM | Max. pressure | | | Flow rate | | Requested power kW | Power supply | Weight | |
|-----------------|-------------------------|------|---------------|------|-----|-----------|-----|-----------------------|-----------------|--------|------|
| | | | bar | psi | MPa | l/m | GPM | | | kg | lbs |
| MP 34-15 11-120 | 34004-00068 | 1450 | 120 | 1740 | 12 | 11 | 2,9 | 3 | 1Ph 230V~50Hz | 22 | 49,2 |
| MP 34-15 11-120 | 34004-00069 | 1750 | 120 | 1740 | 12 | 11 | 2,9 | 3 | 1Ph 220V~60Hz | 22 | 49,2 |
| MP 34-15 11-150 | 34004-00070 | 1450 | 150 | 2175 | 15 | 11 | 2,9 | 4 | 3Ph Y 400V~50Hz | 22,5 | 49,6 |
| MP 34-15 11-150 | 34004-00071 | 1750 | 150 | 2175 | 15 | 11 | 2,9 | 4 | 3Ph Y 400V~60Hz | 22,5 | 49,6 |

MPJ3 series

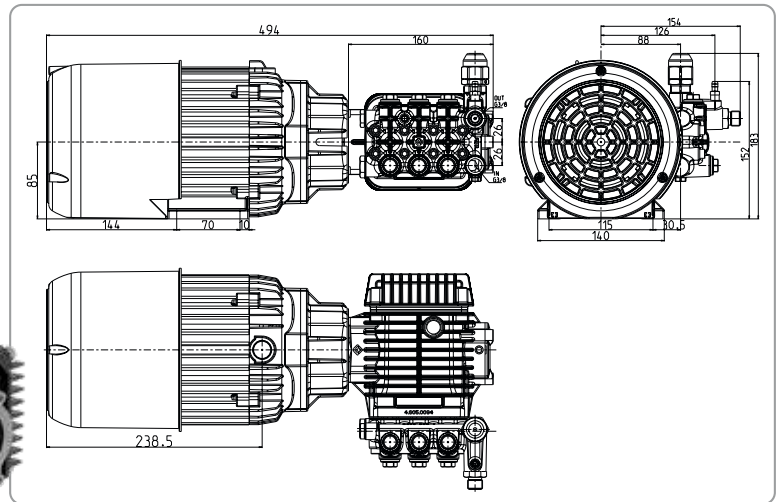

Equipped with:

- High-pressure pumps units with elastic coupling
- Pressure adjuster included

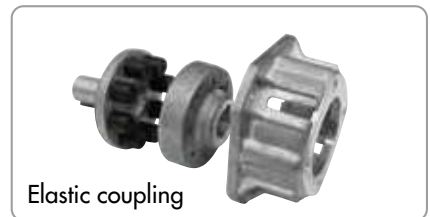

| Model | Left shaft ver. Code | RPM | Max. pressure | | | Flow rate | | Requested power kW | Power supply | Weight | |
|------------------|-------------------------|------|---------------|------|-----|-----------|-----|-----------------------|-----------------|--------|------|
| | | | bar | psi | MPa | l/m | GPM | | | kg | lbs |
| MPJ 34-15 11-120 | 34004-00072 | 1450 | 120 | 1740 | 12 | 11 | 2,9 | 3 | 1Ph 230V~50Hz | 22,5 | 49,6 |
| MPJ 34-15 11-120 | 34004-00073 | 1750 | 120 | 1740 | 12 | 11 | 2,9 | 3 | 1Ph 220V~60Hz | 22,5 | 49,6 |
| MPJ 34-15 15-150 | 34004-00074 | 1450 | 150 | 2175 | 15 | 11 | 2,9 | 4 | 3Ph Y 400V~50Hz | 23 | 50,6 |
| MPJ 34-15 15-150 | 34004-00075 | 1750 | 150 | 2175 | 15 | 11 | 2,9 | 4 | 3Ph Y 400V~60Hz | 23 | 50,6 |

MPW3.5 series

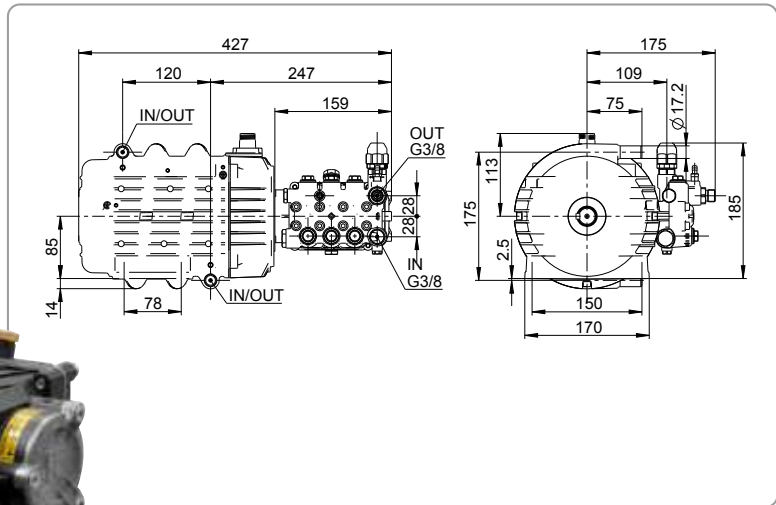

Equipped with:

- Fixing bracket included
- Pressure adjuster included

| Model | Left shaft ver. Code | RPM | Max. pressure | | | Flow rate | | Requested power kW | Power supply | Weight | |
|--------------------|-------------------------|------|---------------|------|-----|-----------|-----|-----------------------|-----------------|--------|------|
| | | | bar | psi | MPa | l/m | GPM | | | kg | lbs |
| MPW 3.54-18 15-150 | 34004-00076 | 1450 | 150 | 2175 | 15 | 15 | 4 | 5 | 3Ph Y 400V~50Hz | 28,8 | 63,5 |
| MPW 3.54-18 15-200 | 34004-00077 | 1450 | 200 | 2900 | 20 | 15 | 4 | 7 | 3Ph Y 400V~50Hz | 30,8 | 67,9 |

MPWJ3.5 series

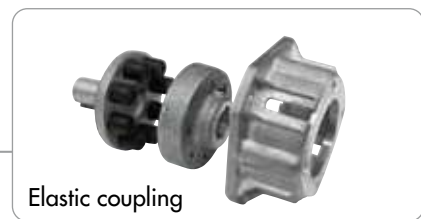
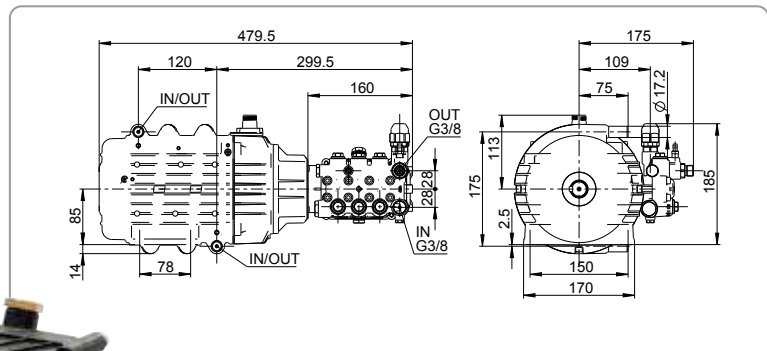

Equipped with:

- High-pressure pumps units with elastic coupling
- Fixing bracket included
- Pressure adjuster included

| Model | Left shaft ver. Code | RPM | Max. pressure | | | Flow rate | | Requested power kW | Power supply | Weight | |
|---------------------|-------------------------|------|---------------|------|-----|-----------|-----|-----------------------|-----------------|--------|------|
| | | | bar | psi | MPa | l/m | GPM | | | kg | lbs |
| MPWJ 3.54-18 15-150 | 34004-00079 | 1450 | 150 | 2175 | 15 | 15 | 4 | 5 | 3Ph Y 400V~50Hz | 29,3 | 64,6 |
| MPWJ 3.54-18 15-200 | 34004-00080 | 1450 | 200 | 2900 | 20 | 15 | 4 | 7 | 3Ph Y 400V~50Hz | 31,3 | 69 |

Le immagini e le specifiche tecniche dei prodotti non sono vincolanti e possono essere modificate senza preavviso

MPW6 series

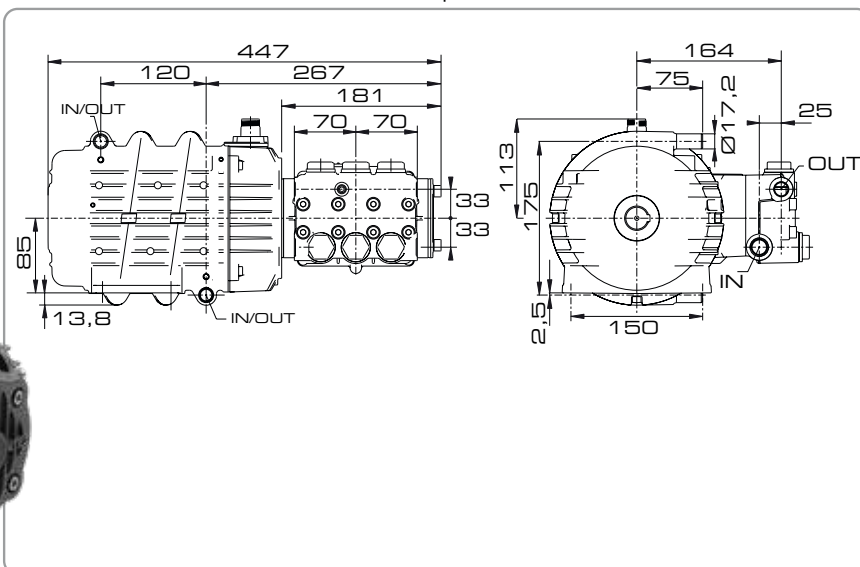

Equipped with:

- Fixing bracket included

| Model | Left shaft ver. Code | RPM | Max. pressure | | | Flow rate | | Requested power kW | Power supply | Weight | |
|------------------|-------------------------|------|---------------|------|-----|-----------|-----|-----------------------|-----------------|--------|------|
| | | | bar | psi | MPa | l/m | GPM | | | kg | lbs |
| MPW 64-20 15-150 | 34004-00009 | 1450 | 150 | 2175 | 15 | 15 | 4 | 5 | 3Ph Y 400V~50Hz | 32 | 70,5 |
| MPW 64-20 15-200 | 34004-00010 | 1450 | 200 | 2900 | 20 | 15 | 4 | 7 | 3Ph Y 400V~50Hz | 34 | 74,9 |

Le immagini e le specifiche tecniche dei prodotti non sono vincolanti e possono essere modificate senza preavviso

MPWJ6 series

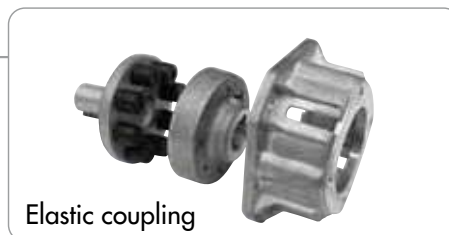
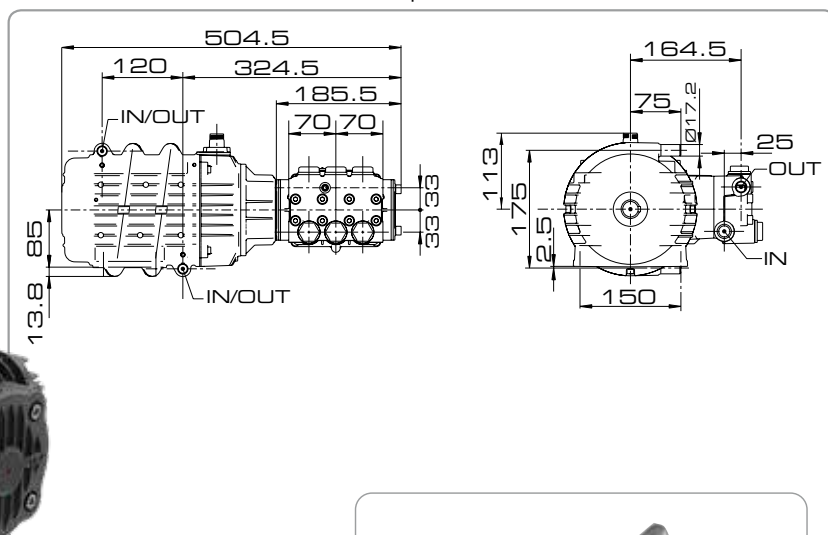

Equipped with:

- High-pressure pumps units with elastic coupling
- Fixing bracket included

| Model | Left shaft ver. Code | RPM | Max. pressure | | | Flow rate | | Requested power kW | Power supply | Weight | |
|-------------------|-------------------------|------|---------------|------|-----|-----------|-----|-----------------------|-----------------|--------|------|
| | | | bar | psi | MPa | l/m | GPM | | | kg | lbs |
| MPWJ 64-20 15-150 | - | 1450 | 150 | 2175 | 15 | 15 | 4 | 5 | 3Ph Y 400V~50Hz | 32,5 | 71,6 |
| MPWJ 64-20 15-200 | 34004-00013 | 1450 | 200 | 2900 | 20 | 15 | 4 | 7 | 3Ph Y 400V~50Hz | 34,5 | 76 |
| MPWJ 64-20 21-200 | 34004-00014 | 1450 | 200 | 2900 | 20 | 21 | 5,5 | 9,4 | 3Ph Y 400V~50Hz | 37,5 | 82,6 |

Top/High/Low series

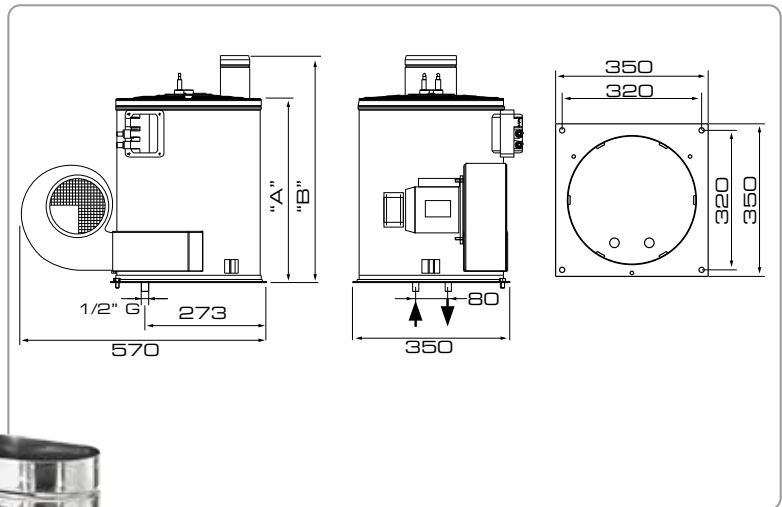

(*) Available in various voltages



Equipped with:

- Complete boilers for high-pressure cleaners

| Model | Code | Max. pressure | | | Flow rate | | Requested power | Power supply (*) | Thermal power | Coil length | Dimension | Weight | |
|-------|-------------|---------------|------|-----|-----------|------|-----------------|------------------|---------------|-------------|-------------------------|--------|-------|
| | | bar | psi | MPa | l/m | GPM | | | | | | W | kg |
| Top | 38002-00010 | 200 | 2900 | 20 | 12 | 3.17 | 300 | 230V ~ 50Hz | 49000 Kcal/h | 20 m | 405 mm (A) - 510 mm (B) | 38 | 85,9 |
| Low | 38002-00001 | 200 | 2900 | 20 | 15 | 3.96 | 300 | 230V ~ 50Hz | 63000 Kcal/h | 29,5 m | 465 mm (A) - 565 mm (B) | 48,5 | 106,8 |
| High | 38002-00002 | 200 | 2900 | 20 | 21 | 5.55 | 300 | 230V ~ 50Hz | 63000 Kcal/h | 36,5 m | 600 mm (A) - 690 mm (B) | 54 | 120 |

Power, air suction, depression: which technical data is most important?

The right technical data of a vacuum cleaner is the vacuum efficiency, that is the mix of different values, i.e. air suction, motor power and depression. Air suction is the vacuumed air volume, commonly expressed in litres per seconds (l/sec) and it is the result of the average air speed multiplied by hose diameter. The depression is the vacuum power (it can be defined as the vacuum power to collect dirt) and it is commonly expressed in kPA or in mbar. It is an inverse relation to air suction: the narrower the flex diameter, the least vacuumed air volume but the best strength to pick up dirt.

Power motor is expressed in Watt and it is not proportional to vacuum efficiency!

If the vacuum cleaner is not well-done, it wastes a lot of electric power without having the best performances possible. Summing up, the vacuum cleaner efficiency is a relationship between air suction (resulting in multiplication of pressure and air suction) and motor power. All our vacuum cleaners have a top efficiency and are manufactured considering essence and user's benefit.

Fixed or tilting trolley, which one to choose?

The choice of the trolley must be made considering the type of use needed. Generally, tilting trolley is much more useful to collect dust and solids, because the tilting tank make it easier

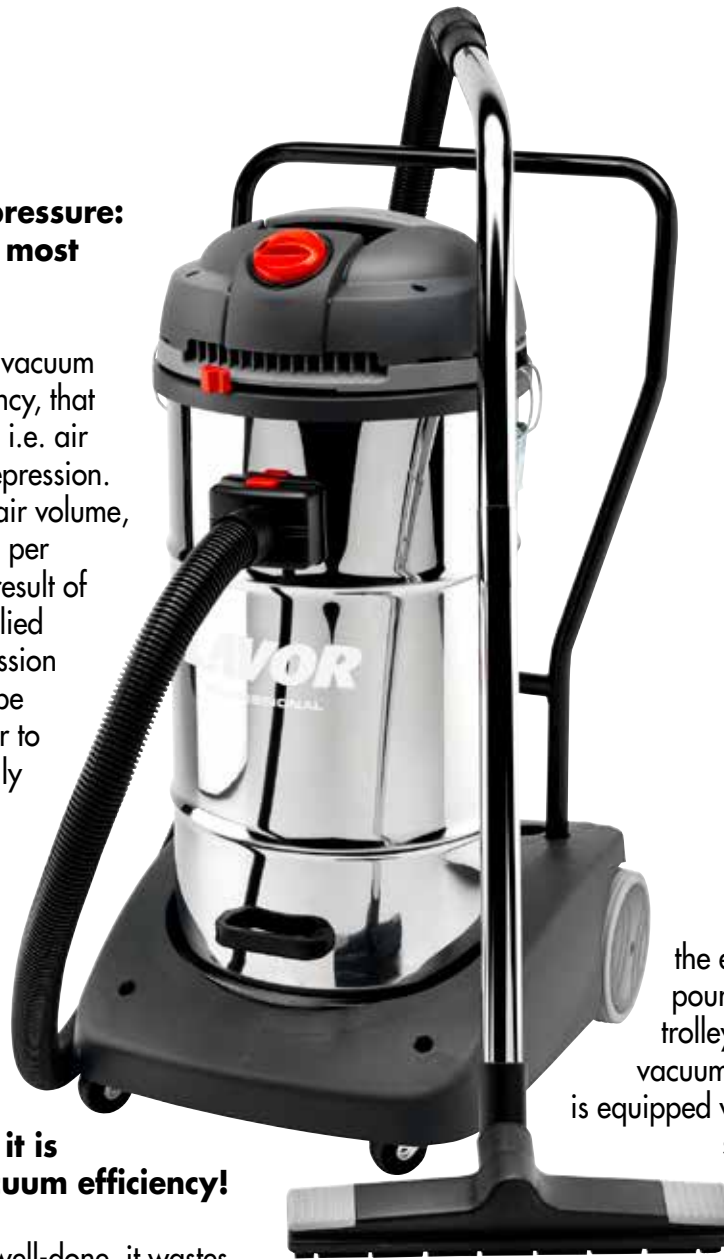

the emptying or pouring. The fixed trolley is better for liquids vacuuming, because it is equipped with drain hose system, emptying is fast and step by step, avoiding the effort of lifting the tank.

What kind of tank material is to be preferred?

Our vacuum cleaner range includes plastic tanks (polypropylene or PP) or stainless steel tanks. The PP tank is flexible, shock proof and resistant to chemical products. It is recommended for frequent moving uses or vacuuming of particularly aggressive chemicals (for example in combination with a single disc machine). The stainless steel tank is more rigid, steadier, resistant to mechanical abrasion and it is aesthetically agreeable. It is recommended for static use, with abrasive materials or in a public place.

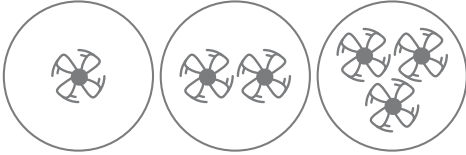

- **Number of motors**

It explains how many motors there are in the vacuum cleaner. Ignition is independent in order to increase progressively the performances. The working system (whenever it is more than one) is in parallel, so the air suction increases and the depression is steady whenever the motors are progressively switched on.



- **Anti electrostatic current device**

Dust rubbing at high speed against vacuum cleaner walls creates a magnetic field that neutralizes on the user with small and annoying discharges also through plastic material. This certified system removes this phenomenon on the machine, granting best comfort and safety for the user.



- **Paper collector filter**

Allows filtering and collection (with a valve) of rough dirt without dirty the tank whenever it is time to replace it. It is useful for dry waste, also in combination of other thinner filters.



- **Cloth filter**

The cloth consistency and its shape allow a simple cleaning phase and the re-usage of the filter. It can be used only for vacuuming dry waste; if combined with nylon filter it is possible to work for a longer period of time.



- **Cartridge filter**

The continuous folders arranged in circle allow a higher filtering surface in a smaller area. More cleaning autonomy with a thin filtering action. It can be used only for vacuuming dry waste and it is re-usable.



- **Multipurpose washable filter**

It combines all the advantages of the cartridge filter but with the plus that it can vacuum both dry and wet at the same time. It can be washed with tap water.



- **HEPA filter**

High Efficiency Particulate Arrestance. Hepa filter is 99,97% efficient until 0,3 micron impurities.



- **Filter shaker**

It clears filter from dust without touching it or opening the vacuum cleaner; the vacuum efficiency is kept at max.



- **Blower function**

In blower mode, a high-velocity stream of air is used to blow away debris from surfaces.



- **Power tool socket**

The vacuum cleaner switches on and off by power tool switching on and off. In this way it is possible to vacuum dust directly without dispersion in the surrounding area.

- **M Class certificate for vacuum cleaner**

It is the ability of the vacuum cleaner to keep (through the filtering system and the manufacturing specifications of the vacuum cleaner) the 99,9% of all vacuumed dust with OEL (Occupational Exposure Limit) higher than a 0,1 mg/m³. Some example of the dusts that can be kept with these vacuum cleaners are working residuals of: wood, copper, insecticide and pesticide, manganese (tools of the earth-moving equipments), platinum, nickel etc.



Nomenclature

Windy 365 IF

Number of motors

Tank capacity (litres)

F = Fixed
R = Tiling

P = Plastic
I = Stainless steel

Technical information

| Code | Model | Page | Voltage | Motor power | Column depression | Air suction | Tank capacity | Noise level | Packaging L x l x H | Packaging weight | Packaging weight | Pieces for pallet |
|-------------|--------------|------|--------------------|-------------|------------------------|-------------|---------------|-------------|---------------------|------------------|------------------|-------------------|
| | | | V - Hz | W/W max | kPa/mmH ₂ O | l/s | l | dB (A) | cm | kg | lbs | N° |
| 40025-00019 | SILENT | 142 | 230V - 50Hz | 800/900 | 24/2400 | 44 l/s | 12 l | 72 dB (A) | 39x39x42 | 7,4 | 16 | 30 |
| 40006-00021 | WHISPER | 144 | 230V - 50Hz | 800/900 | 24/2400 | 44 l/s | 15 l | 72 dB (A) | 49x39x42 | 9,5 | 20 | 20 |
| 40041-00016 | PRO WORKER | 146 | 220/240V - 50/60Hz | 1200/1400 | 24/2400 | 70 l/s | 30 l | 75 dB (A) | 51x36x56 | 11 | 24 | 16 |
| 40008-00031 | WINDY 120 PF | 148 | 230V - 50Hz | 1200/1400 | 24/2400 | 65 l/s | 20 l | 79 dB (A) | 38x37x62 | 10 | 22 | 18 |
| 40008-00001 | WINDY 120 IF | 150 | 230V - 50Hz | 1200/1400 | 24/2400 | 65 l/s | 20 l | 79 dB (A) | 38x37x62 | 10 | 22 | 18 |
| 40008-00030 | WINDY 130 PF | 152 | 230V - 50Hz | 1200/1400 | 24/2400 | 65 l/s | 30 l | 79 dB (A) | 38x37x70 | 11 | 24 | 18 |
| 40008-00018 | WINDY 130 IF | 154 | 230V - 50Hz | 1200/1400 | 24/2400 | 65 l/s | 30 l | 79 dB (A) | 38x37x70 | 11 | 24 | 18 |
| 40009-00017 | WINDY 165 PF | 156 | 230V - 50Hz | 1200/1400 | 24/2400 | 65 l/s | 65 l | 79 dB (A) | 75x60x103 | 30,5 | 67 | 4 |
| 40009-00016 | WINDY 165 IF | 158 | 230V - 50Hz | 1200/1400 | 24/2400 | 65 l/s | 65 l | 79 dB (A) | 75x60x103 | 30,5 | 67 | 4 |
| 40018-00005 | WINDY 265 PF | 160 | 230V - 50Hz | 2000/2400 | 22/2200 | 130 l/s | 65 l | 79 dB (A) | 60x48x87 | 18,8 | 41 | 8 |
| 40018-00001 | WINDY 265 IF | 162 | 230V - 50Hz | 2000/2400 | 22/2200 | 130 l/s | 65 l | 79 dB (A) | 60x48x87 | 19,8 | 44 | 8 |
| 40020-00001 | WINDY 365 IR | 164 | 230V - 50Hz | 3000/3600 | 22/2200 | 195 l/s | 65 l | 79 dB (A) | 65x55x104 | 25,5 | 56 | 4 |
| 40019-00002 | WINDY 278 PF | 166 | 230V - 50Hz | 2000/2400 | 22/2200 | 130 l/s | 78 l | 79 dB (A) | 75x60x103 | 29,6 | 65 | 4 |
| 40019-00001 | WINDY 278 IF | 168 | 230V - 50Hz | 2000/2400 | 22/2200 | 130 l/s | 78 l | 79 dB (A) | 75x60x103 | 29,6 | 65 | 4 |



| Code | Model | Page | Voltage | Motor power | Column depression | Air suction | Tank capacity | Noise level | Packaging L x l x H | Packaging weight | Packaging weight | Pieces for pallet |
|-------------|-----------------|------|-------------|-------------|------------------------|-------------|---------------|-------------|---------------------|------------------|------------------|-------------------|
| | | | V - Hz | W/W max | kPa/mmH ₂ O | l/s | l | dB (A) | cm | kg | lbs | N° |
| 40021-00006 | WINDY 378 PF | 170 | 230V - 50Hz | 3000/3600 | 22/2200 | 195 l/s | 78 l | 79 dB (A) | 75x60x103 | 30,5 | 67 | 4 |
| 40021-00001 | WINDY 378 IR | 172 | 230V - 50Hz | 3000/3600 | 22/2200 | 195 l/s | 78 l | 79 dB (A) | 75x60x103 | 30,5 | 67 | 4 |
| 40007-00001 | ZEUS IF | 174 | 230V - 50Hz | 1200/1400 | 24/2400 | 53 l/s | 50 l | 71 dB (A) | 64x54x92 | 21,5 | 47 | 4 |
| 40005-00009 | DOMUS PR | 176 | 230V - 50Hz | 2000/2400 | 24/2400 | 108 l/s | 78 l | 74 dB (A) | 75x60x103 | 30,5 | 67 | 4 |
| 40005-00023 | DOMUS IF | 178 | 230V - 50Hz | 2000/2400 | 24/2400 | 108 l/s | 78 l | 74 dB (A) | 75x60x103 | 30,5 | 67 | 4 |
| 40005-00001 | DOMUS IR | 180 | 230V - 50Hz | 2000/2400 | 24/2400 | 108 l/s | 78 l | 74 dB (A) | 75x60x103 | 33,5 | 74 | 4 |
| 40004-00008 | TAURUS PR | 182 | 230V - 50Hz | 3000/3600 | 24/2400 | 162 l/s | 77 l | 76 dB (A) | 75x60x103 | 32,5 | 71 | 4 |
| 40004-00001 | TAURUS IR | 184 | 230V - 50Hz | 3000/3600 | 24/2400 | 162 l/s | 78 l | 76 dB (A) | 75x60x103 | 34,5 | 76 | 4 |
| 40004-00023 | TAURUS IR 2 Way | 186 | 230V - 50Hz | 3000/3600 | 24/2400 | 162 l/s | 78 l | 76 dB (A) | 75x60x103 | 32 | 70 | 4 |
| 40003-00009 | HYDRUS | 190 | 230V - 50Hz | 1200/1400 | 27/2700 | 70 l/s | 20 l | 75 dB (A) | 40x39x64 | 9,5 | 20,9 | 18 |
| 40038-00001 | JUPITER | 192 | 230V - 50Hz | 1100 | 23/2300 | 50 l/s | 6,5 l | 70 dB (A) | 60x40x48 | 14 | 31 | 16 |
| 40010-00001 | APOLLO IF | 194 | 230V - 50Hz | 1200/1400 | 24/2400 | 53 l/s | 50 l | 71 dB (A) | 64x54x92 | 24 | 53 | 4 |
| 40011-00002 | SOLARIS IF | 196 | 230V - 50Hz | 2200/2400 | 24/2400 | 108 l/s | 78 l | 74 dB (A) | 75x60x103 | 37 | 82 | 4 |
| 40011-00008 | COSTELLATION IR | 198 | 230V - 50Hz | 2200/2400 | 24/2400 | 108 l/s | 78 l | 74 dB (A) | 75x60x103 | 37 | 82 | 4 |

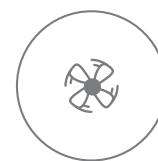

Silent**LONG LIFE
MOTOR****CHARACTERISTICS**

Professional ultra silent vacuum cleaners, Lavor Silent was conceived to meet the needs of floor care sector. • Silenced single stage motor (high efficiency). • Integrated accessory holder. • Shock and overturn proof design. • 12 litre plastic tank (PP) • Cloth filter • Rotating ON/OFF switch • Paper collector filter. • 10 m high visibility power cable. • Accessories Ø 32

TECHNICAL DATA

| | Silent |
|-----------------------|--------------------------------|
| code | 40025-00019 |
| voltage | 220-240V ~ 50-60Hz |
| n°motors - power | 1 - 800 W |
| column depression | 24 kPa/2400 mmH ₂ O |
| air suction | 44 l/s |
| total volume | 12 l. |
| dimension (cm)/weight | 39x39x42/6,8 kg |

PLUS



Rotating ON/OFF and comfortable carrying handle



Power cable holder and accessory storage facility (accessories d. 32 mm)











12 litre plastic tank (PP) and swivel connection to avoid tangles in the flex hose



Shock and overturn proof design

STANDARD EQUIPMENT

| | | | | |
|---|---|---|--|--|
|  <p>• 00080-05155 Hose 2 m</p> |  <p>• 00080-05167</p> |  <p>• 00080-05162</p> |  <p>• 00080-05160</p> |  <p>• 00080-05158</p> |
|  <p>• 00070-00774</p> |  <p>• 00070-00776 Cloth filter</p> |  <p>• 10 m power cable high visibility</p> | | |

OPTIONAL

| | | | | |
|--|---------------------------------|--|--|--|
| <p>• 10001-13222 Paper collector filter set (10 pcs)</p> | <p>• Hepa filter on request</p> | | | |
|--|---------------------------------|--|--|--|

Whisper

**LONG LIFE
MOTOR**



Microfiber



HEPA

MORE INFO



CHARACTERISTICS

- Ultra silenced single stage motor (high efficiency).
- Microfiber collector filter.
- Hepa filter
- Full collector filter indicator.
- Exhaust air filter.
- Integrated accessory holder.
- Shock & overturn proof design.
- Traceless wheels.
- 10 m power cable high visibility.
- Accessories Ø 32

TECHNICAL DATA

| | Whisper |
|-----------------------|--------------------------------|
| code | 40006-00021 |
| voltage | 230V ~ 50Hz |
| n°motors - power | 1 - 800 W |
| column depression | 24 kPa/2400 mmH ₂ O |
| air suction | 44 l/s |
| total volume | 15 l. |
| dimension (cm)/weight | 47x34x36 / 8,5 kg |

PLUS



Integrated accessory storage facility (accessories d. 32 mm) and comfortable carrying handle



Ultra silenced high efficiency single stage motor and exhaust air filter













Non-marking wheels and accessory storage facility on the base



Shock and overturn proof design

STANDARD EQUIPMENT

| | | | | |
|---|---|---|---|--|
|  <p>Hose 2,5 m</p> |  <ul style="list-style-type: none"> • 00080-05167 |  <ul style="list-style-type: none"> • 00080-05162 |  <ul style="list-style-type: none"> • 00080-05160 |  <ul style="list-style-type: none"> • floor brush |
|  <ul style="list-style-type: none"> • 00080-05159 |  <ul style="list-style-type: none"> • Microfiber collector filter |  <ul style="list-style-type: none"> • Hepa filter |  <ul style="list-style-type: none"> • Exhaust air filter |  <ul style="list-style-type: none"> • 10 m power cable high visibility |

OPTIONAL

| | | | | |
|--|---|--|--|--|
| <ul style="list-style-type: none"> • Paper collector filter set (10 pcs) on request | <ul style="list-style-type: none"> • Microfiber collector filter set (10 pcs) on request | | | |
|--|---|--|--|--|

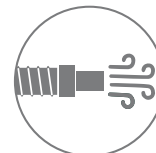
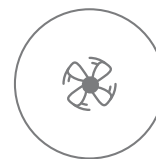
Pro worker EM

MORE INFO

**CHARACTERISTICS**

• High efficiency by pass motor • Suction system with by-pass cooling • Power tool socket (max 2200 W) • Automatic ON/OFF filter shaker • Shock proof tank (PP) • Liquid float valve • Dirty filter indicator • Rotary switch • Hepa filter • Microfiber collector filter • M/E10 suction filter with NANO TECH coating • Extension steel pipe • Multidiameter tool adapter • Flex hose elastic fastening • 7,5 m power cable. • Accessories Ø35.

TECHNICAL DATA

| | PRO Worker EM |
|-----------------------|--------------------------------|
| code | 40041-00016 |
| voltage | 220-240V ~ 50-60Hz |
| n°motors - power | 1 - 1400 W |
| column depression | 24 kPa/2400 mmH ₂ O |
| air suction | 70 l/s |
| volume | 30 l. |
| dimension (cm)/weight | 33x55x55,7/11,8 kg |

PLUS



Accessory storage facility (accessories d. 35 mm) and comfortable carrying handle



Power tool socket (max 2200 Watt) with delayed vacuum shut off



Plastic professional closing hooks



HEPA filter for outlet air, microfiber collector filter and M/E10 suction filter with NANO TECH coating

STANDARD EQUIPMENT

| | | | | |
|---|--|---|--|--|
|  <ul style="list-style-type: none"> • 00080-01623 + 00080-03083 |  <ul style="list-style-type: none"> • 00080-01796 |  <ul style="list-style-type: none"> • 00080-02003 |  <ul style="list-style-type: none"> • 00080-02004 |  <ul style="list-style-type: none"> • 00080-02005 |
|  <ul style="list-style-type: none"> • 00080-01911 |  <ul style="list-style-type: none"> • 00080-01912 |  <ul style="list-style-type: none"> • 00009-02729 |  <ul style="list-style-type: none"> • 00070-00416 M/E 10 filter |  <ul style="list-style-type: none"> • 2x 00070-00601 Microfiber |
|  <ul style="list-style-type: none"> • 00070-00417 |  <ul style="list-style-type: none"> • 00070-00418 Hepa filter |  <ul style="list-style-type: none"> • 00070-00419 | | |

OPTIONAL

| | | | | |
|---|--|--|--|--|
| <ul style="list-style-type: none"> • 10001-08255 Microfiber collector filter set (5 pcs) | <ul style="list-style-type: none"> • 10001-09511 Accessory kit (hose-floor wet and dry accessories) | <ul style="list-style-type: none"> • 10001-08259 M/E filter | <ul style="list-style-type: none"> • 10001-09406 Hepa filter for outlet air | |
|---|--|--|--|--|

Windy 120 PF

MORE INFO

**CHARACTERISTICS**

- High efficiency by pass motor. • Suction system with by-pass cooling. • Plastic tank. • Shock proof trolley. • Liquid float valve. • Cloth filter.
- 7,5 m power cable. • Accessories Ø 35. • Handy accessory holder.

TECHNICAL DATA

| | Windy 120 PF |
|--------------------------|--------------------------------|
| code | 40008-00031 |
| voltage | 220-240V ~ 50-60Hz |
| n° motors - power (max) | 1 - 1200 (1400) W |
| column depression | 24 kPa/2400 mmH ₂ O |
| air suction | 65 l/s |
| total volume/dust/liquid | 20 l./14 l./16 l. |
| dimension (cm)/weight | 40x38x54/8,3 Kg |

PLUS



High efficiency motor, suction system with by-pass cooling, rotating ON/OFF main switch



Professional stainless steel closing hooks



Shock proof plastic tank and liquid float valve for liquid suction



Shock proof trolley with two front pivoting wheels and two big rear wheels for better stability and easy movement

STANDARD EQUIPMENT

| | | | | |
|--|--|--|---|--|
|  • 00080-03988 Hose 2,5 m |  • 10001-09429 |  • 00080-02003 |  • 00080-02004 |  • 00080-02005 |
|  • 00080-01912 |  • 00080-03729 |  • 00080-01911 |  • 00070-00666 Cloth filter |  • 00070-00556 |
|  • 00070-00548 | | | | |

OPTIONAL

| | | | | |
|---|-------------------------------|---|---|--------------------------------|
| • 10001-08169 Paper collector filter set - 10 pcs | • 10001-08186 Cloth filter | • 00080-04315 Brush flor/carpet with wheels | • 00080-01955 Brush carpet Turbo brush Type 2 | • 10001-08248 Cartridge filter |
| • 10001-08249 HEPA filter | • 10001-08246 Washable filter | • 10001-08174 Foam filter | | |

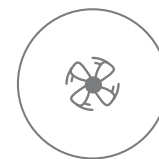
Windy 120 IF

MORE INFO

**CHARACTERISTICS**

- High efficiency by pass motor. • Suction system with by-pass cooling. • Stainless steel tank. • Shock proof trolley. • Liquid float valve. • Cloth filter.
- 7,5 m power cable. • Accessories Ø 35. • Handy accessory holder.

TECHNICAL DATA

| | Windy 120 IF |
|--------------------------|--------------------------------|
| code | 40008-00001 |
| voltage | 220-240V ~ 50-60Hz |
| n°motors - power (max) | 1 - 1200 (1400) W |
| column depression | 24 kPa/2400 mmH ₂ O |
| air suction | 65 l/s |
| total volume/dust/liquid | 20 l./14 l./16 l. |
| dimension (cm)/weight | 35x35x66/8 Kg |

PLUS



High efficiency motor, suction system with by-pass cooling, rotating ON/OFF main switch



Professional stainless steel closing hooks



Anti-corrosion stainless steel tank and liquid float valve for liquid suction



Shock proof trolley with two front pivoting wheels and two big rear wheels for better stability and easy movement

STANDARD EQUIPMENT

| | | | | |
|---|---|---|--|---|
|  <ul style="list-style-type: none"> • 00080-03988 Hose 2,5 m |  <ul style="list-style-type: none"> • 10001-09429 |  <ul style="list-style-type: none"> • 00080-02003 |  <ul style="list-style-type: none"> • 00080-02004 |  <ul style="list-style-type: none"> • 00080-02005 |
|  <ul style="list-style-type: none"> • 00080-01912 |  <ul style="list-style-type: none"> • 00080-03729 |  <ul style="list-style-type: none"> • 00080-01911 |  <ul style="list-style-type: none"> • 00070-00666 Cloth filter |  <ul style="list-style-type: none"> • 00070-00556 |
|  <ul style="list-style-type: none"> • 00070-00548 | | | | |

OPTIONAL

| | | | | |
|---|---|---|---|--|
| <ul style="list-style-type: none"> • 10001-08169 Paper collector filter set - 10 pcs | <ul style="list-style-type: none"> • 10001-08186 Cloth filter | <ul style="list-style-type: none"> • 00080-04315 Brush flor/carpet with wheels | <ul style="list-style-type: none"> • 00080-01955 Brush carpet Turbo brush Type 2 | <ul style="list-style-type: none"> • 10001-08248 Cartridge filter |
| <ul style="list-style-type: none"> • 10001-08249 HEPA filter | <ul style="list-style-type: none"> • 10001-08246 Washable filter | <ul style="list-style-type: none"> • 10001-08174 Foam filter | | |

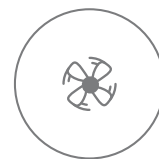
Windy 130 PF

MORE INFO

**CHARACTERISTICS**

• High efficiency by pass motor. • Suction system with by-pass cooling. • Plastic tank. • Shock proof trolley. • Liquid float valve. • Washable filter. • 7,5 m power cable. • Accessories Ø 35. • Handy accessory holder.

TECHNICAL DATA

| | Windy 130 PF |
|--------------------------|--------------------------------|
| code | 40008-00030 |
| voltage | 220-240V ~ 50-60Hz |
| n°motors - power (max) | 1 - 1200 (1400) W |
| column depression | 24 kPa/2400 mmH ₂ O |
| air suction | 65 l/s |
| total volume/dust/liquid | 30 l./15 l./17 l. |
| dimension (cm)/weight | 37x37x71/8,5 Kg |

PLUS



High efficiency motor, suction system with by-pass cooling, rotating ON/OFF main switch, ergonomic handle for easy movement



Professional stainless steel closing hooks



Shock proof plastic tank and liquid float valve for liquid suction



Shock proof trolley with two front pivoting wheels and two big rear wheels for better stability and easy movement

STANDARD EQUIPMENT

| | | | | |
|--|--|--|--|--|
|  • 00080-03988 Hose 2,5 m |  • 10001-09429 |  • 00080-02003 |  • 00080-02004 |  • 00080-02005 |
|  • 00080-01912 |  • 00080-03729 |  • 00080-01911 |  • 00070-00565 Washable filter |  • 00070-00556 |
|  • 00070-00548 | | | | |

OPTIONAL

| | | | | |
|---|----------------------------|---|---|--------------------------------|
| • 10001-08169 Paper collector filter set - 10 pcs | • 10001-08186 Cloth filter | • 00080-04315 Brush flor/carpet with wheels | • 00080-01955 Brush carpet Turbo brush Type 2 | • 10001-08248 Cartridge filter |
| • 10001-08249 HEPA filter | • 10001-08174 Foam filter | | | |

Windy 130 IF

WASHABLE

MORE INFO

**CHARACTERISTICS**

• High efficiency by pass motor. • Suction system with by-pass cooling. • Stainless steel tank. • Shock proof trolley. • Liquid float valve. • Washable filter. • 7,5 m power cable. • Accessories Ø 35. • Handy accessory holder.

TECHNICAL DATA

| | Windy 130 IF |
|--------------------------|--------------------------------|
| code | 40008-00018 |
| voltage | 220-240V ~ 50-60Hz |
| n°motors - power (max) | 1 - 1200 (1400) W |
| column depression | 24 kPa/2400 mmH ₂ O |
| air suction | 65 l/s |
| total volume/dust/liquid | 30 l./15 l./17 l. |
| dimension (cm)/weight | 37x37x71/8,5 Kg |

PLUS



High efficiency motor, suction system with by-pass cooling, rotating ON/OFF main switch, ergonomic handle for easy movement



Professional stainless steel closing hooks



Anti-corrosion stainless steel tank and liquid float valve for liquid suction



Shock proof trolley with two front pivoting wheels and two big rear wheels for better stability and easy movement

STANDARD EQUIPMENT

| | | | | |
|--|--|--|--|--|
|  • 00080-03988 Hose 2,5 m |  • 10001-09429 |  • 00080-02003 |  • 00080-02004 |  • 00080-02005 |
|  • 00080-01912 |  • 00080-03729 |  • 00080-01911 |  • 00070-00565 Washable filter |  • 00070-00556 |
|  • 00070-00548 | | | | |

OPTIONAL

| | | | | |
|---|----------------------------|---|---|--------------------------------|
| • 10001-08169 Paper collector filter set - 10 pcs | • 10001-08186 Cloth filter | • 00080-04315 Brush flor/carpet with wheels | • 00080-01955 Brush carpet Turbo brush Type 2 | • 10001-08248 Cartridge filter |
| • 10001-08249 HEPA filter | • 10001-08174 Foam filter | | | |

Windy 165 PF

MORE INFO

**CHARACTERISTICS**

- High efficiency by pass motor. • Suction system with by-pass cooling. • Plastic tank (PP). • Professional closing hooks. • Shock proof trolley. • Liquid float valve. • Cloth filter. • 7,5 m power cable. • Easy standing head (during filter cleaning). • Traceless wheels. • Accessories Ø 40.

TECHNICAL DATA

| | Windy 165 PF |
|--------------------------|--------------------------------|
| code | 40009-00017 |
| voltage | 220-240V ~ 50-60Hz |
| n°motors - power (max) | 1 - 1200 (1400) W |
| column depression | 24 kPa/2400 mmH ₂ O |
| air suction | 65 l/s |
| total volume/dust/liquid | 65 l./30 l./40 l. |
| dimension (cm)/weight | 44x46x96/11 kg |

PLUS



High efficiency motor, suction system with by-pass cooling, rotating ON/OFF main switch



Professional stainless steel closing hooks and ergonomic handle for easy movement



Shock proof plastic tank and liquid float valve for liquid suction, swivel connection avoiding tangles in the flex hose



Shock proof trolley with pivoting wheels for easy movement and base with accessory storage facility (accessories d. 40 mm)

STANDARD EQUIPMENT

| | | | | |
|---|---|---|--|--|
|  <ul style="list-style-type: none"> • 00080-03979 Hose 2,5 m |  <ul style="list-style-type: none"> • 10001-09446 |  <ul style="list-style-type: none"> • 00080-01931 |  <ul style="list-style-type: none"> • 00080-01932 |  <ul style="list-style-type: none"> • 00080-02015 |
|  <ul style="list-style-type: none"> • 00080-02004 |  <ul style="list-style-type: none"> • 00080-02005 |  <ul style="list-style-type: none"> • 00070-00556 |  <ul style="list-style-type: none"> • 00070-00678 Cloth filter | |

OPTIONAL

| | | | | |
|---|--|--|---|---|
| <ul style="list-style-type: none"> • 10001-08169 Paper collector filter set (10 pcs) | <ul style="list-style-type: none"> • 10001-08209 Nylon filter | <ul style="list-style-type: none"> • 10001-08248 Cartridge filter | <ul style="list-style-type: none"> • 10001-08249 HEPA filter | <ul style="list-style-type: none"> • 10001-08246 Washable filter |
| <ul style="list-style-type: none"> • 10001-08174 Foam filter | | | | |

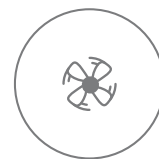
Windy 165 IF

MORE INFO

**CHARACTERISTICS**

- High efficiency by pass motor. • Suction system with by-pass cooling. • Stainless steel tank. • Professional closing hooks. • Shock proof trolley.
- Liquid float valve. • Cloth filter. • 7,5 m power cable. • Easy standing head (during filter cleaning). • Traceless wheels. • Accessories Ø 40.

TECHNICAL DATA

| | Windy 165 IF |
|--------------------------|--------------------------------|
| code | 40009-00016 |
| voltage | 220-240V ~ 50-60Hz |
| n°motors - power (max) | 1 - 1200 (1400) W |
| column depression | 24 kPa/2400 mmH ₂ O |
| air suction | 65 l/s |
| total volume/dust/liquid | 65 l./30 l./40 l. |
| dimension (cm)/weight | 44x46x96/12,5 kg |

PLUS



High efficiency motor, suction system with by-pass cooling, rotating ON/OFF main switch



Professional stainless steel closing hooks and ergonomic handle for easy movement



Anti-corrosion stainless steel tank and liquid float valve for liquid suction, swivel connection avoiding tangles in the flex hose



Shock proof trolley with pivoting wheels for easy movement and base with accessory storage facility (accessories d. 40 mm)

STANDARD EQUIPMENT

| | | | | |
|---|---|---|--|--|
|  <ul style="list-style-type: none"> • 00080-03979 Hose 2,5 m |  <ul style="list-style-type: none"> • 10001-09446 |  <ul style="list-style-type: none"> • 00080-01931 |  <ul style="list-style-type: none"> • 00080-01932 |  <ul style="list-style-type: none"> • 00080-02015 |
|  <ul style="list-style-type: none"> • 00080-02004 |  <ul style="list-style-type: none"> • 00080-02005 |  <ul style="list-style-type: none"> • 00070-00556 |  <ul style="list-style-type: none"> • 00070-00678 Cloth filter | |

OPTIONAL

| | | | | |
|---|--|--|---|---|
| <ul style="list-style-type: none"> • 10001-08169 Paper collector filter set (10 pcs) | <ul style="list-style-type: none"> • 10001-08209 Nylon filter | <ul style="list-style-type: none"> • 10001-08248 Cartridge filter | <ul style="list-style-type: none"> • 10001-08249 HEPA filter | <ul style="list-style-type: none"> • 10001-08246 Washable filter |
| <ul style="list-style-type: none"> • 10001-08174 Foam filter | | | | |

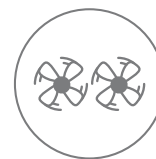
Windy 265 PF

MORE INFO

**CHARACTERISTICS**

- 2 high efficiency by pass motors. • Suction system with by-pass cooling. • Filter cleaning system. • Plastic tank (PP). • Shock proof trolley.
- Liquid float valve. • Cloth filter. • 7,5 m power cable. • Traceless wheels. • Accessories Ø 40. • Handy accessory holder. • Pneumatic filter shaker

TECHNICAL DATA

| | Windy 265 PF |
|--------------------------|--------------------------------|
| code | 40018-00005 |
| voltage | 220-240V ~ 50-60Hz |
| n°motors - power (max) | 2 - 2000 (2400) W |
| column depression | 22 kPa/2200 mmH ₂ O |
| air suction | 130 l/s |
| total volume/dust/liquid | 65 l./30 l./40 l. |
| dimension (cm)/weight | 44x46x96/13 kg |

PLUS



2 high efficiency motors, suction system with by-pass cooling, rotating ON/OFF main switch



Pneumatic filter shaker and flow reverse for perfect filter cleaning for top vacuum performances



Shock proof plastic tank and liquid float valve for liquid suction, swivel connection avoiding tangles in the flex hose



Shock proof trolley with pivoting wheels for easy movement and base with accessory storage facility (accessories d. 40 mm)

STANDARD EQUIPMENT

| | | | | |
|--|---|--|---|---|
|  <ul style="list-style-type: none"> • 00080-03979 Hose 2,5 m |  <ul style="list-style-type: none"> • 10001-09446 |  <ul style="list-style-type: none"> • 00080-01931 |  <ul style="list-style-type: none"> • 00080-01932 |  <ul style="list-style-type: none"> • 00080-01956 |
|  <ul style="list-style-type: none"> • 00080-01957 |  <ul style="list-style-type: none"> • 00080-01958 |  <ul style="list-style-type: none"> • 10001-09468 Cloth filter | | |

OPTIONAL

| | | | | |
|---|--|--|--|--|
| <ul style="list-style-type: none"> • 10001-08169 Paper collector filter set (10 pcs) | <ul style="list-style-type: none"> • 00070-00673 Cloth filter for fine dust | <ul style="list-style-type: none"> • 10001-08208 Nylon filter | | |
|---|--|--|--|--|

Windy 265 IF

MORE INFO

**CHARACTERISTICS**

• 2 high efficiency by pass motors. • Suction system with by-pass cooling. • Filter cleaning system. • Stainless steel tank. • Static electric shock inhibitor. • Shock proof trolley. • Liquid float valve. • Cloth filter. • 7,5 m power cable. • Traceless wheels. • Accessories Ø 40. • Handy accessory holder. • Pneumatic filter shaker

TECHNICAL DATA

| | Windy 265 IF |
|--------------------------|--------------------------------|
| code | 40018-00001 |
| voltage | 220-240V ~ 50-60Hz |
| n°motors - power (max) | 2 - 2000 (2400) W |
| column depression | 22 kPa/2200 mmH ₂ O |
| air suction | 130 l/s |
| total volume/dust/liquid | 65 l./30 l./40 l. |
| dimension (cm)/weight | 44x46x96/14,5 kg |

PLUS



2 high efficiency motors, suction system with by-pass cooling, rotating ON/OFF main switch



Pneumatic filter shaker and flow reverse for perfect filter cleaning for top vacuum performances



Anti-corrosion stainless steel tank and liquid float valve for liquid suction, swivel connection avoiding tangles in the flex hose



Shock proof trolley with pivoting wheels for easy movement and base with accessory storage facility (accessories d. 40 mm)

STANDARD EQUIPMENT

| | | | | |
|---|--|---|--|--|
|  <p>• 00080-03979 Hose 2,5 m</p> |  <p>• 10001-09446</p> |  <p>• 00080-01931</p> |  <p>• 00080-01932</p> |  <p>• 00080-01956</p> |
|  <p>• 00080-01957</p> |  <p>• 00080-01958</p> |  <p>• 10001-09468 Cloth filter</p> | | |

OPTIONAL

| | | | | |
|--|---|-----------------------------------|--|--|
| <p>• 10001-08169 Paper collector filter set (10 pcs)</p> | <p>• 00070-00673 Cloth filter for fine dust</p> | <p>• 10001-08208 Nylon filter</p> | | |
|--|---|-----------------------------------|--|--|

Windy 365 IR

MORE INFO

**CHARACTERISTICS**

- 3 high efficiency by pass motors.
- Suction system with by-pass cooling.
- Filter cleaning system.
- Stainless steel tank.
- Static electric shock inhibitor.
- Tilting tank.
- Fully removable tank.
- Shock proof trolley.
- Liquid float valve.
- Cloth filter.
- 7,5 m power cable.
- Traceless wheels.
- Accessories Ø 40.
- Handy accessory holder.
- Pneumatic filter shaker

TECHNICAL DATA

| | Windy 365 IR |
|--------------------------|--------------------------------|
| code | 40020-00001 |
| voltage | 220-240V ~ 50-60Hz |
| n°motors - power (max) | 3 - 3000 (3600) W |
| column depression | 22 kPa/2200 mmH ₂ O |
| air suction | 195 l/s |
| total volume/dust/liquid | 65 l./30 l./40 l. |
| dimension (cm)/weight | 62x51x100/20 kg |

PLUS



3 high efficiency motors, suction system with by-pass cooling, rotating ON/OFF main switch



Pneumatic filter shaker and flow reverse for perfect filter cleaning for top vacuum performances



Antistatic device eliminating those annoying magnetic fields that can form inside the tank due to the high speed movement of particles. Improves user's comfort of use



Tilting anti-corrosion stainless steel tank for easy emptying and fully removable tank if necessary

STANDARD EQUIPMENT

| | | | | |
|---|--|---|--|--|
|  <p>• 00080-03979 Hose 2,5 m</p> |  <p>• 10001-09446</p> |  <p>• 00080-01931</p> |  <p>• 00080-01932</p> |  <p>• 00080-01956</p> |
|  <p>• 00080-01957</p> |  <p>• 00080-01958</p> |  <p>• 10001-09468 Cloth filter</p> | | |

OPTIONAL

| | | | | |
|--|---|-----------------------------------|--|--|
| <p>• 10001-08169 Paper collector filter set (10 pcs)</p> | <p>• 00070-00673 Cloth filter for fine dust</p> | <p>• 10001-08208 Nylon filter</p> | | |
|--|---|-----------------------------------|--|--|

Windy 278 PF

MORE INFO

**CHARACTERISTICS**

- 2 high efficiency by pass motors. • Suction system with by-pass cooling. • Filter cleaning system. • Plastic tank (PP). • Shock proof trolley. • Liquid float valve. • Drain hose system. • Static electric shock inhibitor. • 7,5 m power cable. • Traceless wheels. • Accessories Ø 40. • Handy accessory holder. • Pneumatic filter shaker • Pneumatic filter shaker

TECHNICAL DATA

| | Windy 278 PF |
|--------------------------|--|
| code | 40019-00002 |
| voltage | 220-240V ~ 50-60Hz |
| n° motors - power (max) | 2 - 2000 (2400) W High efficiency motor. |
| column depression | 22 kPa/2200 mmH ₂ O |
| air suction | 130 l/s |
| total volume/dust/liquid | 78 l./35 l./48 l. |
| dimension (cm)/weight | 62x51x96/21,5 kg |

PLUS



2 high efficiency motors, suction system with by-pass cooling, rotating ON/OFF main switch



Pneumatic filter shaker and flow reverse for perfect filter cleaning for top vacuum performances



Drain hose system for tank easy emptying



Shock proof trolley with pivoting wheels for easy movement and base with accessory storage facility (accessories d. 40 mm)

STANDARD EQUIPMENT

| | | | | |
|---|--|---|--|--|
|  <p>• 00080-03979 Hose 2,5 m</p> |  <p>• 10001-09446</p> |  <p>• 00080-01931</p> |  <p>• 00080-01932</p> |  <p>• 00080-01956</p> |
|  <p>• 00080-01957</p> |  <p>• 00080-01958</p> |  <p>• 10001-09544 Cloth filter</p> | | |

OPTIONAL

| | | | | |
|--|---|-----------------------------------|--------------------------------------|----------------------------------|
| <p>• 10001-08169 Paper collector filter set (10 pcs)</p> | <p>• 10001-09545 Cloth filter for fine dust</p> | <p>• 10001-08208 Nylon filter</p> | <p>• 10001-08168 Washable filter</p> | <p>• 10001-08178 Hepa filter</p> |
|--|---|-----------------------------------|--------------------------------------|----------------------------------|

Windy 278 IF

MORE INFO

**CHARACTERISTICS**

• 2 high efficiency by pass motors. • Suction system with by-pass cooling. • Filter cleaning system. • Stainless steel tank. • Static electric shock inhibitor. • Shock proof trolley. • Liquid float valve. • Cloth filter. • Drain hose system. • 7,5 m power cable. • Traceless wheels. • Accessories Ø 40. • Handy accessory holder. • Pneumatic filter shaker

TECHNICAL DATA

| | Windy 278 IF |
|--------------------------|--|
| code | 40019-00001 |
| voltage | 220-240V ~ 50-60Hz |
| n°motors - power (max) | 2 - 2000 (2400) W High efficiency motor. |
| column depression | 22 kPa/2200 mmH ₂ O |
| air suction | 130 l/s |
| total volume/dust/liquid | 78 l./35 l./48 l. |
| dimension (cm)/weight | 62x51x96/23 kg |

PLUS



2 high efficiency motors, suction system with by-pass cooling, rotating ON/OFF main switch



2 Pneumatic filter shaker and flow reverse for perfect filter cleaning for top vacuum performances



Drain hose system for tank easy emptying



Shock proof trolley with pivoting wheels for easy movement and base with accessory storage facility (accessories d. 40 mm)

STANDARD EQUIPMENT

| | | | | |
|---|--|---|--|--|
|  <p>• 00080-03979 Hose 2,5 m</p> |  <p>• 10001-09446</p> |  <p>• 00080-01931</p> |  <p>• 00080-01932</p> |  <p>• 00080-01956</p> |
|  <p>• 00080-01957</p> |  <p>• 00080-01958</p> |  <p>• 10001-09544 Cloth filter</p> | | |

OPTIONAL

| | | | | |
|--|---|-----------------------------------|--------------------------------------|----------------------------------|
| <p>• 10001-08169 Paper collector filter set (10 pcs)</p> | <p>• 10001-09545 Cloth filter for fine dust</p> | <p>• 10001-08208 Nylon filter</p> | <p>• 10001-08168 Washable filter</p> | <p>• 10001-08178 Hepa filter</p> |
|--|---|-----------------------------------|--------------------------------------|----------------------------------|

Windy 378 PF

MORE INFO

**CHARACTERISTICS**

• 3 high efficiency by pass motors. • Suction system with by-pass cooling. • Filter cleaning system. • Plastic tank (PP). • Shock proof trolley. • Liquid float valve. • Static electric shock inhibitor. • Drain hose system. • 7,5 m power cable. • Traceless wheels. • Accessories Ø 40. • Handy accessory holder. • Pneumatic filter shaker

TECHNICAL DATA

| | Windy 378 PF |
|--------------------------|--|
| code | 40021-00006 |
| voltage | 220-240V ~ 50-60Hz |
| n°motors - power (max) | 3 - 3000 (3600) W High efficiency motor. |
| column depression | 22 kPa/2200 mmH ₂ O |
| air suction | 195 l/s |
| total volume/dust/liquid | 78 l./35 l./48 l. |
| dimension (cm)/weight | 62x51x99/23,5 kg |

PLUS



3 high efficiency motors, suction system with by-pass cooling, rotating ON/OFF main switch



Pneumatic filter shaker and flow reverse for perfect filter cleaning for top vacuum performances



Drain hose system for tank easy emptying



Shock proof trolley with pivoting wheels for easy movement and base with accessory storage facility (accessories d. 40 mm)

STANDARD EQUIPMENT

| | | | | |
|---|--|---|--|--|
|  <p>• 00080-03979 Hose 2,5 m</p> |  <p>• 10001-09446</p> |  <p>• 00080-01931</p> |  <p>• 00080-01932</p> |  <p>• 00080-01956</p> |
|  <p>• 00080-01957</p> |  <p>• 00080-01958</p> |  <p>• 10001-09544 Cloth filter</p> | | |

OPTIONAL

| | | | | |
|--|---|-----------------------------------|--------------------------------------|----------------------------------|
| <p>• 10001-08169 Paper collector filter set (10 pcs)</p> | <p>• 10001-09545 Cloth filter for fine dust</p> | <p>• 10001-08208 Nylon filter</p> | <p>• 10001-08168 Washable filter</p> | <p>• 10001-08178 Hepa filter</p> |
|--|---|-----------------------------------|--------------------------------------|----------------------------------|

Windy 378 IR

MORE INFO

**CHARACTERISTICS**

• 3 high efficiency by pass motors. • Suction system with by-pass cooling. • Filter cleaning system. • Stainless steel tank. • Static electric shock inhibitor. • Tilting tank. • Fully removable tank. • Shock proof trolley. • Liquid float valve. • Cloth filter. • 7,5 m power cable. • Traceless wheels. • Accessories Ø 40. • Handy accessory holder. • Pneumatic filter shaker

TECHNICAL DATA

| | Windy 378 IR |
|--------------------------|--|
| code | 40021-00001 |
| voltage | 220-240V ~ 50-60Hz |
| n°motors - power (max) | 3 - 3000 (3600) W High efficiency motor. |
| column depression | 22 kPa/2200 mmH ₂ O |
| air suction | 195 l/s |
| total volume/dust/liquid | 78 l./35 l./48 l. |
| dimension (cm)/weight | 62x51x99/26 kg |

PLUS



3 high efficiency motors, suction system with by-pass cooling, rotating ON/OFF main switch



Pneumatic filter shaker and flow reverse for perfect filter cleaning for top vacuum performances



Antistatic device eliminating those annoying magnetic fields that can form inside the tank due to the high speed movement of particles. Improves user's comfort of use



Tilting anti-corrosion stainless steel tank for easy emptying and fully removable tank if necessary

STANDARD EQUIPMENT

| | | | | |
|---|--|---|--|--|
|  <p>• 00080-03979 Hose 2,5 m</p> |  <p>• 10001-09446</p> |  <p>• 00080-01931</p> |  <p>• 00080-01932</p> |  <p>• 00080-01956</p> |
|  <p>• 00080-01957</p> |  <p>• 00080-01958</p> |  <p>• 10001-09544 Cloth filter</p> | | |

OPTIONAL

| | | | | |
|--|---|-----------------------------------|--------------------------------------|----------------------------------|
| <p>• 10001-08169 Paper collector filter set (10 pcs)</p> | <p>• 10001-09545 Cloth filter for fine dust</p> | <p>• 10001-08208 Nylon filter</p> | <p>• 10001-08168 Washable filter</p> | <p>• 10001-08178 Hepa filter</p> |
|--|---|-----------------------------------|--------------------------------------|----------------------------------|

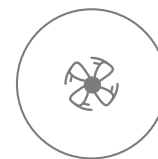
Zeus IF

MORE INFO

**CHARACTERISTICS**

• Silenced two stage motor. • Suction system with by-pass cooling. • Stainless steel tank. • Professional closing hooks. • Static electric shock inhibitor. • Drain hose system. • Shock proof trolley. • Liquid float valve. • Cloth filter. • 10 m power cable. • Easy standing head (during filter cleaning). • Traceless wheels. • Accessories Ø 40.

TECHNICAL DATA

| | Zeus IF |
|--------------------------|----------------------------------|
| code | 40007-00001 |
| voltage | 220-240V ~ 50-60Hz |
| n°motors - power (max) | 1 - 1200 (1400) W |
| column depression | 21,6 kPa/2200 mmH ₂ O |
| air suction | 53 l/s |
| total volume/dust/liquid | 50 l./21 l./35 l. |
| dimension (cm)/weight | 62x51x85/16,5 kg |

PLUS



Antistatic device eliminating those annoying magnetic fields that can form inside the tank due to the high speed movement of particles. Improves user's comfort of use



Shock proof trolley with two front pivoting wheels and two big rear wheels for better stability and easy movement



Drain hose system for tank easy emptying



Anti-corrosion stainless steel tank and liquid float valve for liquid suction

STANDARD EQUIPMENT

| | | | | |
|--|---|---|--|---|
|  <ul style="list-style-type: none"> • 00080-03979 Hose 2,5 m |  <ul style="list-style-type: none"> • 10001-09446 |  <ul style="list-style-type: none"> • 00080-01931 |  <ul style="list-style-type: none"> • 00080-01932 |  <ul style="list-style-type: none"> • 00080-02015 |
|  <ul style="list-style-type: none"> • 00080-02004 |  <ul style="list-style-type: none"> • 00080-02005 |  <ul style="list-style-type: none"> • 10001-09339 |  <ul style="list-style-type: none"> • 10001-09337 Cloth filter | |

OPTIONAL

| | | | | |
|---|--|---|--|---|
| <ul style="list-style-type: none"> • 10001-08169 Paper collector filter set (10 pcs) | <ul style="list-style-type: none"> • 10001-08209 Nylon filter | <ul style="list-style-type: none"> • 10001-08251 Washable filter | <ul style="list-style-type: none"> • 10001-08252 Cartridge filter | <ul style="list-style-type: none"> • 10001-08253 HEPA filter |
|---|--|---|--|---|

Domus PR

MORE INFO

**CHARACTERISTICS**

• 2 silenced two stage motor. • Suction system with by-pass cooling. • Plastic tank (PP). • Professional closing hooks. • Tilting tank. • Fully removable tank. • Static electric shock inhibitor. • Shock proof trolley. • Liquid float valve. • Cloth filter. • 10 m power cable. • Easy standing head (during filter cleaning). • Cable holder. • Traceless wheels. • Accessories Ø 40.

TECHNICAL DATA

| | Domus PR |
|--------------------------|--|
| code | 40005-00009 |
| voltage | 220-240V ~ 50-60Hz |
| n°motors - power (max) | 2 - 2000 (2400) W silenced two stage motor |
| column depression | 22 kPa/2240 mmH ₂ O |
| air suction | 108 l/s |
| total volume/dust/liquid | 78 l./35 l./48 l. |
| dimension (cm)/weight | 62x51x99/28,5 kg |

PLUS



Anti-tipping head support, very useful while filter cleaning or when opening the tank for emptying



Shock proof trolley with two front pivoting wheels and two big rear wheels for better stability and easy movement



Antistatic device eliminating those annoying magnetic fields that can form inside the tank due to the high speed movement of particles. Improves user's comfort of use



Tilting plastic tank for easy emptying and fully removable tank if necessary

STANDARD EQUIPMENT

| | | | | |
|---|--|---|--|--|
|  <p>• 00080-03979 Hose 2,5 m</p> |  <p>• 10001-09446</p> |  <p>• 00080-01931</p> |  <p>• 00080-01932</p> |  <p>• 00080-01956</p> |
|  <p>• 00080-01957</p> |  <p>• 00080-01958</p> |  <p>• 00070-00679 Cloth filter</p> | | |

OPTIONAL

| | | | | |
|--|---|-----------------------------------|--------------------------------------|----------------------------------|
| <p>• 10001-08169 Paper collector filter set (10 pcs)</p> | <p>• 10001-09545 Cloth filter for fine dust</p> | <p>• 10001-08208 Nylon filter</p> | <p>• 10001-08168 Washable filter</p> | <p>• 10001-08178 Hepa filter</p> |
|--|---|-----------------------------------|--------------------------------------|----------------------------------|

Domus IF

MORE INFO

**CHARACTERISTICS**

• 2 silenced two stage motor. • Suction system with by-pass cooling. • Stainless steel tank. • Professional closing hooks. • Static electric shock inhibitor. • Drain hose system. • Shock proof trolley. • Liquid float valve. • Cloth filter. • 10 m power cable. • Easy standing head (during filter cleaning). • Traceless wheels. • Accessories Ø 40.

TECHNICAL DATA

| | Domus IF |
|--------------------------|--|
| code | 40005-00023 |
| voltage | 220-240V ~ 50-60Hz |
| n°motors - power (max) | 2 - 2000 (2400) W silenced two stage motor |
| column depression | 22 kPa/2240 mmH ₂ O |
| air suction | 108 l/s |
| total volume/dust/liquid | 78 l./35 l./48 l. |
| dimension (cm)/weight | 62x51x85/28 kg |

PLUS



Anti-tipping head support, very useful while filter cleaning or when opening the tank for emptying



Anti-corrosion stainless steel tank and liquid float valve for liquid suction



Drain hose system for tank easy emptying



Shock proof trolley with two front pivoting wheels and two big rear wheels for better stability and easy movement

STANDARD EQUIPMENT

| | | | | |
|--|---|--|---|---|
|  <ul style="list-style-type: none"> • 00080-03979 Hose 2,5 m |  <ul style="list-style-type: none"> • 10001-09446 |  <ul style="list-style-type: none"> • 00080-01931 |  <ul style="list-style-type: none"> • 00080-01932 |  <ul style="list-style-type: none"> • 00080-01956 |
|  <ul style="list-style-type: none"> • 00080-01957 |  <ul style="list-style-type: none"> • 00080-01958 |  <ul style="list-style-type: none"> • 00070-00679 Cloth filter | | |

OPTIONAL

| | | | | |
|---|--|--|---|---|
| <ul style="list-style-type: none"> • 10001-08169 Paper collector filter set (10 pcs) | <ul style="list-style-type: none"> • 10001-09545 Cloth filter for fine dust | <ul style="list-style-type: none"> • 10001-08208 Nylon filter | <ul style="list-style-type: none"> • 10001-08168 Washable filter | <ul style="list-style-type: none"> • 10001-08178 Hepa filter |
|---|--|--|---|---|

Domus IR

MORE INFO

**CHARACTERISTICS**

• 2 silenced two stage motor. • Suction system with by-pass cooling. • Stainless steel tank. • Professional closing hooks. • Static electric shock inhibitor. • Tilting tank. • Fully removable tank. • Shock proof trolley. • Liquid float valve. • Cloth filter. • 10 m power cable. • Easy standing head (during filter cleaning). • Cable holder. • Traceless wheels. • Accessories Ø 40.

TECHNICAL DATA

| | Domus IR |
|--------------------------|--|
| code | 40005-00001 |
| voltage | 220-240V ~ 50-60Hz |
| n°motors - power (max) | 2 - 2000 (2400) W silenced two stage motor |
| column depression | 22 kPa/2240 mmH ₂ O |
| air suction | 108 l/s |
| total volume/dust/liquid | 78 l./35 l./48 l. |
| dimension (cm)/weight | 62x51x99/32 kg |

PLUS



Anti-tipping head support, very useful while filter cleaning or when opening the tank for emptying



Shock proof trolley with two front pivoting wheels and two big rear wheels for better stability and easy movement



Antistatic device eliminating those annoying magnetic fields that can form inside the tank due to the high speed movement of particles. Improves user's comfort of use



Tilting anti-corrosion stainless steel tank for easy emptying and fully removable tank if necessary

STANDARD EQUIPMENT

| | | | | |
|--|---|--|---|---|
|  <ul style="list-style-type: none"> • 00080-03979 Hose 2,5 m |  <ul style="list-style-type: none"> • 10001-09446 |  <ul style="list-style-type: none"> • 00080-01931 |  <ul style="list-style-type: none"> • 00080-01932 |  <ul style="list-style-type: none"> • 00080-01956 |
|  <ul style="list-style-type: none"> • 00080-01957 |  <ul style="list-style-type: none"> • 00080-01958 |  <ul style="list-style-type: none"> • 00070-00679 Cloth filter | | |

OPTIONAL

| | | | | |
|---|--|--|---|---|
| <ul style="list-style-type: none"> • 10001-08169 Paper collector filter set (10 pcs) | <ul style="list-style-type: none"> • 10001-09545 Cloth filter for fine dust | <ul style="list-style-type: none"> • 10001-08208 Nylon filter | <ul style="list-style-type: none"> • 10001-08168 Washable filter | <ul style="list-style-type: none"> • 10001-08178 Hepa filter |
|---|--|--|---|---|

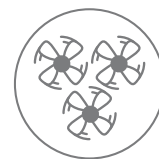
Taurus PR

MORE INFO

**CHARACTERISTICS**

• 3 silenced two stage motor. • Suction system with by-pass cooling. • Plastic tank (PP). • Professional closing hooks. • Tilting tank. • Fully removable tank. • Static electric shock inhibitor. • Shock proof trolley. • Liquid float valve. • Cloth filter. • 10 m power cable. • Easy standing head (during filter cleaning). • Cable holder. • Traceless wheels. • Accessories Ø 40.

TECHNICAL DATA

| | Taurus PR |
|--------------------------|--|
| code | 40004-00008 |
| voltage | 220-240V ~ 50-60Hz |
| n°motors - power (max) | 3 - 3000 (3600) W silenced two stage motor |
| column depression | 22 kPa/2240 mmH ₂ O |
| air suction | 162 l/s |
| total volume/dust/liquid | 78 l./35 l./48 l. |
| dimension (cm)/weight | 62x51x99/29,5 kg |

PLUS



Anti-tipping head support, very useful while filter cleaning or when opening the tank for emptying



Shock proof trolley with two front pivoting wheels and two big rear wheels for better stability and easy movement



Antistatic device eliminating those annoying magnetic fields that can form inside the tank due to the high speed movement of particles. Improves user's comfort of use



Tilting plastic tank for easy emptying and fully removable tank if necessary

STANDARD EQUIPMENT

| | | | | |
|---|--|---|--|--|
|  <p>• 00080-03979 Hose 2,5 m</p> |  <p>• 10001-09446</p> |  <p>• 00080-01931</p> |  <p>• 00080-01932</p> |  <p>• 00080-01956</p> |
|  <p>• 00080-01957</p> |  <p>• 00080-01958</p> |  <p>• 00070-00679 Cloth filter</p> | | |

OPTIONAL

| | | | | |
|--|---|-----------------------------------|--------------------------------------|----------------------------------|
| <p>• 10001-08169 Paper collector filter set (10 pcs)</p> | <p>• 10001-09545 Cloth filter for fine dust</p> | <p>• 10001-08208 Nylon filter</p> | <p>• 10001-08168 Washable filter</p> | <p>• 10001-08178 Hepa filter</p> |
|--|---|-----------------------------------|--------------------------------------|----------------------------------|

Taurus IR

MORE INFO

**CHARACTERISTICS**

• 3 silenced two stage motor. • Suction system with by-pass cooling. • Stainless steel tank. • Professional closing hooks. • Static electric shock inhibitor. • Tilting tank. • Fully removable tank. • Shock proof trolley. • Liquid float valve. • Cloth filter. • 10 m power cable. • Easy standing head (during filter cleaning). • Cable holder. • Traceless wheels. • Accessories Ø 40.

TECHNICAL DATA

| | Taurus IR |
|--------------------------|--|
| code | 40004-00001 |
| voltage | 220-240V ~ 50-60Hz |
| n°motors - power (max) | 3 - 3000 (3600) W silenced two stage motor |
| column depression | 22 kPa/2240 mmH ₂ O |
| air suction | 162 l/s |
| total volume/dust/liquid | 78 l./35 l./48 l. |
| dimension (cm)/weight | 62x51x99/33 kg |

PLUS



Anti-tipping head support, very useful while filter cleaning or when opening the tank for emptying



Shock proof trolley with two front pivoting wheels and two big rear wheels for better stability and easy movement



Antistatic device eliminating those annoying magnetic fields that can form inside the tank due to the high speed movement of particles. Improves user's comfort of use



Tilting anti-corrosion stainless steel tank for easy emptying and fully removable tank if necessary

STANDARD EQUIPMENT

| | | | | |
|--|---|--|---|---|
|  <ul style="list-style-type: none"> • 00080-03979 Hose 2,5 m |  <ul style="list-style-type: none"> • 10001-09446 |  <ul style="list-style-type: none"> • 00080-01931 |  <ul style="list-style-type: none"> • 00080-01932 |  <ul style="list-style-type: none"> • 00080-01956 |
|  <ul style="list-style-type: none"> • 00080-01957 |  <ul style="list-style-type: none"> • 00080-01958 |  <ul style="list-style-type: none"> • 00070-00679 Cloth filter | | |

OPTIONAL

| | | | | |
|---|--|--|---|---|
| <ul style="list-style-type: none"> • 10001-08169 Paper collector filter set (10 pcs) | <ul style="list-style-type: none"> • 10001-09545 Cloth filter for fine dust | <ul style="list-style-type: none"> • 10001-08208 Nylon filter | <ul style="list-style-type: none"> • 10001-08168 Washable filter | <ul style="list-style-type: none"> • 10001-08178 Hepa filter |
|---|--|--|---|---|

Taurus IR 2 Way

MORE INFO

**CHARACTERISTICS**

• 3 silenced two stage motor. • Stainless steel tank. • Professional closing hooks. • Static electric shock inhibitor. • Suction system with by-pass cooling. • Tilting tank. • Fully removable tank. • Shock proof trolley. • Liquid float valve. • Cloth filter. • 10 m power cable. • Easy standing head (during filter cleaning). • Cable holder. • Traceless wheels. • Accessories Ø 40.

TECHNICAL DATA

| | Taurus IR 2 Way |
|--------------------------|--|
| code | 40004-00023 |
| voltage | 220-240V ~ 50-60Hz |
| n° motors - power (max) | 3 - 3000 (3600) W silenced two stage motor |
| column depression | 22 kPa/2240 mmH ₂ O |
| air suction | 162 l/s |
| total volume/dust/liquid | 78 l./35 l./48 l. |
| dimension (cm)/weight | 62x51x99 /33 kg |

PLUS



Anti-tipping head support, very useful while filter cleaning or when opening the tank for emptying



Shock proof trolley with two front pivoting wheels and two big rear wheels for better stability and easy movement







Additional hose connection to allow two operators to work simultaneously



Tilting anti-corrosion stainless steel tank for easy emptying and fully removable tank if necessary

STANDARD EQUIPMENT

| | | | | |
|--|---|---|--|--|
|  <ul style="list-style-type: none"> • 2 x 00080-03990 Hose 5 m |  <ul style="list-style-type: none"> • 2 x 00080-01931 |  <ul style="list-style-type: none"> • 2 x 00080-01932 |  <ul style="list-style-type: none"> • 00070-00679 Cloth filter | |
|--|---|---|--|--|

OPTIONAL

| | | | | |
|---|--|---|--|--|
| <ul style="list-style-type: none"> • 10001-09446 - Ø 40 chromium plated steel curve and extension pipe kit | <ul style="list-style-type: none"> • 10001-09441 - Ø 40 complete accessories kit (holder accessories, floor brush, wet tool, carpet tool) | <ul style="list-style-type: none"> • 10001-08208 Cloth filter for fine dust. | | |
|---|--|---|--|--|

Injection extraction range



Lavor professional extraction/injection machines: **Hydrus, Jupiter, Apollo, Solaris, Costellation** are the real solution to clean any type of textiles!

Machines equipped with 6,5 up to 78 liters tanks, 1 or 2 double stage motors, 1 or 2 detergent pumps to assure always the right flow of injected chemical.

Provided with a full range of accessories capable to suit each deep cleaning textile application: carpets, vehicle seats, sofas, tents, chairs, mats, etc... To be used in the **HO-RE-CA, Automotive** and **Industrial** cleaning, they will perfectly fit any requirements.

A range of injection/extraction cleaning machines ideal for car cleaning, as they can be used with thick foam or liquid detergent.

Equipped with a connection for compressed air with pressure regulator and an external tank of 12 liters capacity, which allows detergent refilling without opening the machine.





- **Number of motors**

It explains how many motors there are in the vacuum cleaner. Ignition is independent in order to increase progressively the performances. The working system (whenever it is more than one) is in parallel, so the air suction increases and the depressure is steady whenever the motors are progressively switched on.



- **Cloth filter**

The cloth consistency and its shape allow a simple cleaning phase and the re-usage of the filter. It can be used only for vacuuming dry waste; if combined with nylon filter it is possible to work for a longer period of time.



- **Paper collector filter**

Allows filtering and collection (with a valve) of rough dirt without dirty the tank whenever it is time to replace it. It is useful for dry waste, also in combination of other thinner filters.



- **Multipurpose washable filter**

It combines all the advantages of the cartridge filter but with the plus that it can vacuum both dry and wet at the same time. It can be washed with tap water.



- **Antistatic machines and accessories**

Using specific conductive materials and engineering, there's the prevention of ignition sparks from the machine side, up to the end of any tool available for this machine range.



- **Unlimited autonomy**

The boiler is refilled by a water pump that gets water from an external water tank. This system allows an unlimited autonomy, because it is not necessary to turn off the steam generator and wait a lower temperature to refill with water. An automatic control recharges the boiler when necessary. In some models there is an acoustic signal advising about low water level inside the water tank.

Hydrus

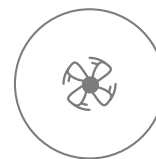

MORE INFO



CHARACTERISTICS

- Silenced single stage motor. • Suction system with by-pass cooling. • 20 lt. plastic tank (PP) • 2 lt. Solution tank • Shock proof trolley. • Liquid float valve. • 7,5 m power cable. • Washable filter • Paper collector filter • Detergent pump 48W - 0,7 l/min - 7 bar max • Accessories Ø 35.
- No stop refilling, unlimited autonomy

TECHNICAL DATA

| | Hydrus |
|------------------------|--------------------------------|
| code | 40003-00009 |
| voltage | 230V ~ 50Hz |
| n°motors - power (max) | 1 - 1200 (1400) W |
| column depression | 27 kPa/2700 mmH ₂ O |
| air suction | 70 l/s |
| total volume | 20 l. |
| dimension (cm)/weight | 40x39x64/9,5 kg |

PLUS



Motor with suction system with by-pass cooling. Detergent pump 48W - 0,7 l/min - 5 bar



20 litres plastic tank



Shock proof trolley with two front pivoting wheels and two big rear wheels for better stability and easy movement



2 l detergent solution tank, instantly rechargeable when the indicator light turns on, unlimited autonomy

STANDARD EQUIPMENT

| | | | | |
|---|--|--|--|--|
|  • 10001-09516 Hose 2 m |  • 00080-01796 |  • 00080-03058 |  • 00080-03037 |  • 00080-01912 |
|  • 00080-03729 |  • 00080-01911 |  • 00080-02017 |  • 00080-02016 |  • 10001-08251 Washable filter |
|  • 00070-00533 |  • 00070-00535 | | | |

OPTIONAL

| | | | | |
|--|-------------------------------|--|--|--|
| • 00073-00142 LC-PREFOAM (no foaming system) | • 10001-09542 Antifoam device | | | |
|--|-------------------------------|--|--|--|

Jupiter

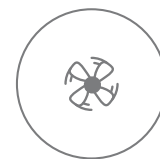

MORE INFO



CHARACTERISTICS

- Spray-extraction cleaner with a separate anti-foaming tank.
- Designed for rug, carpet, and upholstery cleaning in offices, clinics, cinemas and households, as well as car upholstery.
- Thorough cleaning through the 4 bar spray pressure and 230 mbar suction power.
- Spray and extraction functions are separately operable.
- Separate fresh and wastewater tanks, each containing 6,5 l.
- Separate container for anti-foaming agent.
- Clear, ergonomic nozzles.
- Long stainless steel vacuum tube for convenient, effortless work.
- 7,5 m power cable.
- Rubber-coated castor wheels and large back wheels.

TECHNICAL DATA

| | Jupiter |
|--------------------------|--------------------------------|
| code | 40038-00001 |
| voltage | 220-230V ~ 50/60Hz |
| n°motors - power (max) | 1 - 1100 W |
| column depression | 23 kPa/2300 mmH ₂ O |
| air suction | 50 l/s |
| total volume/dust/liquid | 6,5 l./5 l./6 l. |
| dimension (cm)/weight | 55 x 35 x 63,5/13 kg |

PLUS

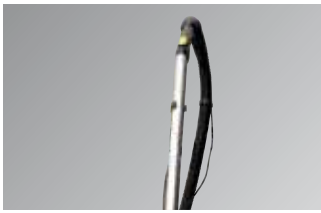

Long stainless steel vacuum tube for convenient, effortless work



Thorough cleaning through the 4 bar spray pressure and 230 mbar suction power



Professional plastic hooks



Rubber-coated castor wheels and large back wheels.

STANDARD EQUIPMENT

| | | | | |
|---|--|--|--|--|
|  <p>• 00080-01637 Hose 2,5 m</p> |  <p>• 2 x 00014-01066</p> |  <p>• 00080-03139</p> |  <p>• 00080-03140</p> | |
|---|--|--|--|--|

Apollo IF

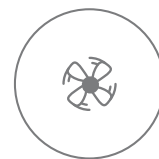

MORE INFO



CHARACTERISTICS

• Silenced two stage motor. • Suction system with by-pass cooling. • Stainless steel tank. • Detergent pump (1x26W – 1,2 l/m – 2,5bar) • Professional closing hooks. • Static electric shock inhibitor. • Drain hose system. • 11 l. detergent tank. • Shock proof trolley. • Liquid float valve. • Cloth filter. • 10 m power cable. • Easy standing head (during filter cleaning). • Traceless wheels. • Accessories Ø 40.

TECHNICAL DATA

| | Apollo IF |
|--------------------------|----------------------------------|
| code | 40010-00001 |
| voltage | 220-240V ~ 50Hz |
| n°motors - power (max) | 1 - 1200 (1400) W |
| column depression | 21,6 kPa/2200 mmH ₂ O |
| air suction | 53 l/s |
| total volume/dust/liquid | 50 l./21 l./35 l. |
| dimension (cm)/weight | 62x51x85/22 kg |

PLUS



Double stage motor, suction system with by-pass cooling, float valve and antistatic device



Detergent pump 26W – 1,2 l/m – 2,5 bar



Shock proof trolley with two front pivoting wheels and two big rear wheels for better stability and easy movement, 11 l detergent solution tank and 50 l stainless steel tank



Drain hose system for tank easy emptying

STANDARD EQUIPMENT

| | | | | |
|--|---|---|---|--|
|  <ul style="list-style-type: none"> • 10001-09449 Hose 2,5 m |  <ul style="list-style-type: none"> • 10001-09452 |  <ul style="list-style-type: none"> • 00080-03052 |  <ul style="list-style-type: none"> • 10001-09339 |  <ul style="list-style-type: none"> • 10001-09337 Cloth filter |
|--|---|---|---|--|

OPTIONAL

| | | | | |
|---|--|---|--|---|
| <ul style="list-style-type: none"> • 10001-08169 Paper collector filter set (10 pcs) | <ul style="list-style-type: none"> • 10001-08209 Nylon filter | <ul style="list-style-type: none"> • 10001-08251 Washable filter | <ul style="list-style-type: none"> • 10001-08252 Cartridge filter | <ul style="list-style-type: none"> • 10001-08253 HEPA filter |
|---|--|---|--|---|

Solaris IF



MORE INFO



CHARACTERISTICS

- Silenced two stage motor.
- Suction system with by-pass cooling.
- Stainless steel tank.
- Detergent pump (2x48W – 1 l/m – 7 bar).
- Professional closing hooks.
- Static electric shock inhibitor.
- Drain hose system.
- 25 l. detergent tank.
- Shock proof trolley.
- Liquid float valve.
- Cloth filter.
- 10 m power cable.
- Easy standing head (during filter cleaning).
- Traceless wheels.
- Accessories Ø 40.

TECHNICAL DATA

| | Solaris IF |
|--------------------------|--|
| code | 40011-00002 |
| voltage | 220-230V ~ 50Hz |
| n°motors - power (max) | 2 - 2200 (2400) W silenced two stage motor |
| column depression | 22 kPa/2240 mmH ₂ O |
| air suction | 108 l/s |
| total volume/dust/liquid | 78 l./35 l./48 l. |
| dimension (cm)/weight | 62x51x96/33 kg |

PLUS



2 double stage motors, suction system with by-pass cooling, float valve and antistatic device



2 detergent pumps 48W – 1 l/m – 7 bar



Shock proof trolley with two front pivoting wheels and two big rear wheels for better stability and easy movement, 25 l detergent solution tank and 78 l stainless steel tank



Drain hose system for tank easy emptying

STANDARD EQUIPMENT

| | | | | |
|--|---|---|--|--|
|  <ul style="list-style-type: none"> • 10001-09449 Hose 2,5 m |  <ul style="list-style-type: none"> • 10001-09452 |  <ul style="list-style-type: none"> • 00080-03052 |  <ul style="list-style-type: none"> • 00070-00679 Cloth filter | |
|--|---|---|--|--|

OPTIONAL

| | | | | |
|---|--|--|---|---|
| <ul style="list-style-type: none"> • 10001-08169 Paper collector filter set (10 pcs) | <ul style="list-style-type: none"> • 10001-09545 Cloth filter for fine dust | <ul style="list-style-type: none"> • 10001-08208 Nylon filter | <ul style="list-style-type: none"> • 10001-08168 Washable filter | <ul style="list-style-type: none"> • 10001-08178 HEPA filter |
|---|--|--|---|---|

Costellation IR



MORE INFO



CHARACTERISTICS

- 2 silenced two stage motor.
- Suction system with by-pass cooling.
- Stainless steel tank.
- Detergent pump (2x48W – 0,7-1,2 l/m – 5 bar).
- Professional closing hooks.
- Static electric shock inhibitor.
- Tilting tank.
- Fully removable tank.
- 11 l. detergent tank.
- Shock proof trolley.
- Liquid float valve.
- Cloth filter.
- 10 m power cable.
- Easy standing head (during filter cleaning).
- Traceless wheels.
- Accessories Ø 40.

TECHNICAL DATA

| | Costellation IR |
|--------------------------|--|
| code | 40011-00008 |
| voltage | 220-240V ~ 50Hz |
| n°motors - power (max) | 2 - 2200 (2400) W silenced two stage motor |
| column depression | 22 kPa/2240 mmH ₂ O |
| air suction | 108 l/s |
| total volume/dust/liquid | 78 l./35 l./48 l. |
| dimension (cm)/weight | 62x51x99/35,5 kg |

PLUS



2 double stage motors, suction system with by-pass cooling, float valve and antistatic device



2 detergent pumps 48W – 0,7/1,2 l/m – 5 bar



Shock proof trolley with two front pivoting wheels and two big rear wheels for better stability and easy movement, 11 l detergent solution tank and 78 l stainless steel tank



Tilting anti-corrosion stainless steel tank for easy emptying and fully removable tank if necessary

STANDARD EQUIPMENT

| | | | | |
|--|---|---|--|--|
|  <ul style="list-style-type: none"> • 10001-09449 Hose 2,5 m |  <ul style="list-style-type: none"> • 10001-09452 |  <ul style="list-style-type: none"> • 00080-03052 |  <ul style="list-style-type: none"> • 00070-00679 Cloth filter | |
|--|---|---|--|--|

OPTIONAL

| | | | | |
|--|--|---|---|--|
| <ul style="list-style-type: none"> • 10001-09545 Cloth filter for fine dust | <ul style="list-style-type: none"> • 10001-08208 Nylon filter | <ul style="list-style-type: none"> • 10001-08168 Washable filter | <ul style="list-style-type: none"> • 10001-08178 HEPA filter | |
|--|--|---|---|--|

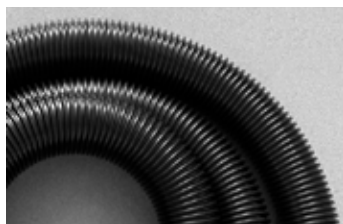

Flexible hose Ø 35

| Code | Description | m | Ø |
|-------------|--------------------------------------|----|----|
| 00014-01446 | Roll of flexible hose without swivel | 30 | 35 |

| Code | Description | Ø |
|------|-------------|---|
|------|-------------|---|



| | | |
|-------------|------------------|----|
| 00014-02331 | Sleeve tank side | 35 |
|-------------|------------------|----|



| | | |
|-------------|----------------------------------|----|
| 00009-02504 | Swivel straight accessories side | 35 |
|-------------|----------------------------------|----|



| | | |
|-------------|--------------------------------|----|
| 00026-01126 | Swivel curved accessories side | 35 |
|-------------|--------------------------------|----|



Flexible hose Ø 40

| Code | Description | m | Ø |
|-------------|--------------------------------------|----|----|
| 00014-01444 | Roll of flexible hose without swivel | 30 | 40 |

| Code | Description | Ø |
|------|-------------|---|
|------|-------------|---|



| | | |
|-------------|------------------|----|
| 00014-02334 | Sleeve tank side | 40 |
|-------------|------------------|----|



| | | |
|-------------|---------------------------|----|
| 00014-02333 | Straight accessories side | 40 |
|-------------|---------------------------|----|

Complete flexible hose Ø 40



| Code | Description | m | Ø |
|-------------|--|----|----|
| 00080-03990 | Flexible hose | 5 | 40 |
| 10001-09450 | Flexible hose for Injection extraction | 5 | 40 |
| 10001-09451 | Flexible hose for Injection extraction | 10 | 40 |



PVC spacer

Code 00035-00531



Ø 40 Spacer for plastic bag 58 l. (for Domus/Taurus/Solaris/Costellation models)
 This accessory is necessary when using collector bag: the use of collector bag is not possible without PVC spacer.
 The use of the collector bag grants easy filter cleaning and its quick replacement whenever necessary, saving time also during the operation of tank cleaning.



Ø 40 Gangway tool (only for Domus PR/Domus IR/Taurus PR/Taurus IR/Costellation IR models)

A set made of special accessory with front and back squeegee + a flex connection hose in order to vacuum easily and quickly water and liquid from the floor.

00085-02558 front squeegee strip with hole
 00085-02559 rear squeegee strip without hole

Gangway tool (only for liquid suction)

Code 00080-03076



Turbo brush Ø 35

Code 00080-01955



Antifoam device

Code 00080-03080

This device avoids the forming of foam that may affect the operation of the float.
 (For Zeus, Domus, Taurus, Apollo, Solaris, Costellation models)



Why wider filtering area is not making automatically a better machine?

In the industrial sector, productivity, resistance and breakeven expectations are growing. The ideal vacuum would be then a machine filtering any kind of dust (also the thinnest) being able to work continuously without the need to clean the filter and without any maintenance.

It is more important to get close effectively to this target rather than the way we can reach this. This is the reason why is useless having a big filtering area if the filter is still clogging up fast and more often I need to stop working to clean it.

In our machines we developed the best prevention of the problem (avoiding dust is reaching quickly the filter) rather than trying a solution afterwards (since the filter is clogging up quickly, extending the filtering area it is supposed to extend the effectiveness). It doesn't matter how wide is the filter, but for how long can work the machine without the need to clean the filter...

And with this issue, we are the best.

When either more airflow or more depression is necessary?

The airflow helps the dirt transport trough long pipes. Longer is the hose, better is bigger airflow; still with light dust it is better having lower depression: the inlet air speed will be lower, the harder the dirt is getting in touch with the filter. When residuals have high specific weight, depression is more important than airflow to win gravity force of dirt attached to the surface.

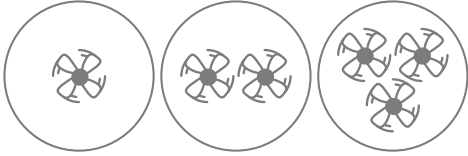

• Number of motors

It explains how many motors there are in the vacuum cleaner. Ignition is independent in order to increase progressively the performances. The working system (whenever it is more than one) is in parallel, so the air suction increases and the depression is steady whenever the motors are progressively switched on.



• Cloth filter

The cloth consistency and its shape allow a simple cleaning phase and the re-usage of the filter. It can be used only for vacuuming dry waste; if combined with nylon filter it is possible to work for a longer period of time.



• Cartridge filter

The continuous folders arranged in circle allow a higher filtering surface in a smaller area.

More cleaning autonomy with a thin filtering action. It can be used only for vacuuming dry waste and it is re-usable.



• Multipurpose washable filter

It combines all the advantages of the cartridge filter but with the plus that it can vacuum both dry and wet at the same time. It can be washed with tap water.



• **Pocket filter:** has a large filtering surface, guarantees high air filtration efficiency and a notable dust accumulation capacity



• Integrated submersible pump in the tank

the draining is continuous and without stopping working.

With this accessory it is possible to push out completely also melting residual up to 20 mm.



• Automatic self cleaning filter system (international copyright)

continuous vacuum performance without maintenance filters are automatically cleaned by mechanical vibration. It is not necessary to touch the filter or clean it outside the vacuum cleaner spreading again dust everywhere.



• Manual filter shaker

Mechanical horizontal and simple manual filter cleaning system



• Antistatic machine and accessories

Using specific conductive materials and engineering, there's the prevention of ignition sparks from the machine side, up to the end of any tool available for this machine range.

Nomenclature

S = Universal (motor)
D = Induction (motor)
P = Pneumatic

M = Single phase (motor)
T = Tri-Phase (motor)
V = Varnishing (tank)
X = Stainless steel (tank)

SMX 77 2-24 SH

Liters (tank) x 100 = 2400 W
Dust class
Filter shaker
n° Motor

Technical information

| Code | Model | Page | Voltage | Abs. Power | Column depression | Suction air | Tank capacity | Noise level | Filtering surface | Packaging | Packaging weight | Packaging weight | Pieces for pallet |
|-------------|-------------------|------|----------------------|------------|-------------------|-------------|---------------|-------------|-----------------------|--------------|------------------|------------------|-------------------|
| | | | V-Hz (Ph) | W | kPa | l/s | l | dB(A) | cm ² | cm L x l x H | kg | lbs | n° |
| 40033-00003 | SMX-R 80 3-36S DS | 206 | 230 V-50-60 Hz (1Ph) | 3000 | 24 kPa | 162 l/s | 80 l. | 76 dB(A) | 4460 cm ² | 70x91x141 | 66 | 145,5 | 1 |
| 40039-00007 | SMV100 3-36 SAH | 208 | 230 V-50 Hz | 3300 | 24 kPa | 142 l/s | 100 | 78 dB(A) | 27000 cm ² | 90x70x190 | 81 | 178 | 1 |
| 40034-00001 | DMX-R 80 1-22 | 210 | 230 V-50 Hz | 2200 | 25 kPa | 97 l/s | 80 | <74 dB(A) | 4300 cm ² | 78x66x175 | 80 | 176 | 1 |
| 40034-00002 | DTX-R 80 1-30 | 210 | 400 V-50 Hz (3Ph) | 3000 | 32 kPa | 97 l/s | 80 | <74 dB(A) | 4300 cm ² | 78x66x175 | 85 | 187 | 1 |



| Code | Model | Page | Voltage | Abs. Power | Column depression | Suction air | Tank capacity | Noise level | Filtering surface | Packaging | Packaging weight | Packaging weight | Pieces for pallet |
|-------------|-----------------|------|-------------------|------------|-------------------|-------------|---------------|-------------|-------------------|--------------|------------------|------------------|-------------------|
| | | | V-Hz (Ph) | W | kPa | l/s | l | dB(A) | cm ² | cm L x l x H | kg | lbs | n° |
| 40040-00052 | DTV100 1-30 SL | 212 | 400 V-50 Hz (3Ph) | 3000 | 32 kPa | 89 l/s | 100 | 78 dB(A) | 20000 | 90x70x190 | 124 | 273 | 1 |
| 40040-00053 | DTV100 1-30 OIL | 214 | 400 V-50 Hz (3Ph) | 3000 | 32 kPa | 89 l/s | 100 | 78 dB(A) | 20000 | 90x70x190 | 132 | 291 | 1 |
| 40040-00055 | DTV100 1-55 SL | 216 | 400 V-50 Hz (3Ph) | 5500 | 32 kPa | 156 l/s | 100 | 78 dB(A) | 20000 | 120x70x167 | 162 | 357 | 1 |



SMX-R 80



MORE INFO



CHARACTERISTICS

- 3 silenced two stage by-pass cooling motors • Stainless steel container • Mechanical horizontal and simple manual filter cleaning system • Steel closing hooks • Static electric shock inhibitor • Power coated steel structure • Trolley with front pivoting non-marking wheels (with brake) & large inbuilt accessories basket • Liquid float valve. • Drain System

TECHNICAL DATA

| | SMX-R 80 3-365 DS |
|---|----------------------------------|
| code | 40033-00003 |
| abs. power W | 3000 |
| n°/type motor | 3 x two stages universal |
| max vacuum (actual) | 24 kPa (2400 mmH ₂ O) |
| max Airflow | 162 l/s |
| container capacity | 80 l |
| noise level | 76 dB(A) |
| voltage | 220-240 V~50-60 Hz (1Ph) |
| inlet Ø - type (s=straight; t=tangential) | 70 mm - s |
| filtering capacity/surface | 5 µm/ 4460 cm ² |
| cable length | 7,5 m |
| dimension (cm)/weight | 68x58x130/45Kg |

PLUS



3 double stage silenced motors, suction system with by-pass cooling, liquid float valve and antistatic device



80 litres stainless steel tank



Cloth filter and manual filter shaker that keeps the filter clean thanks to a simple manual swing mechanism



Power coated steel structure with front pivoting non-marking wheels with brakes and large inbuilt storage compartment

STANDARD EQUIPMENT

| | | | | |
|--|---|--|--|--|
|  <ul style="list-style-type: none"> • 00070-00679 - Cloth filter | <ul style="list-style-type: none"> • 00014-02300 Quick release adaptor Ø70-50 (1x) | | | |
|--|---|--|--|--|

There isn't any hose or tool provided within the unit.

OPTIONAL

| | | | | |
|--|--|--|--|--|
| <p align="center"> • 10001-09534 KIT 1 for industrial cleaning, included: • 00014-02293 2 x Accessories sleeve eva Ø 50 • 00080-01831 4 x Eva conductive flexible hose Ø 50 (mt 4) • 00026-01129 Steel handle Ø50 • 00080-04097 Dust inox tool • 00080-01589 PVC flat lance with galvanized joint Ø50 • 00080-01590 PVC round brush with galvanized joint Ø50 </p> | | | | |
| <p align="center"> • 10001-09535 KIT 2 for oil and swarf cleaning, included: • 00014-02292 2 x Accessories sleeve PUR/PVC Ø 50 • 00080-01833 4 x Pur antistatic flexible hose Ø 50 (mt 4) • 00040-01251 Galvanized chip basket • 00080-01587 Rubber antistatic round lance Ø50 </p> | | | | |
| <p>Optional minimum set to run the unit:</p> <ul style="list-style-type: none"> • 10001-09372 3m complete EVA Ø50 hose set (1x) + 00080-01589 adapter | | | | |

SMV100 3-36 SAH

ONLY DRY



MORE INFO



CHARACTERISTICS

- 3 silenced two stage by-pass cooling motors • Power coated steel structure and containers • Self-cleaning filter system for continuous operations • 3 HEPA + PTFE cartridge conductive filters • Metal side inlet channel and AISI 304 stainless steel filter protection • Wheeled container with inbuilt quick release handle, drain plug and full load level • Trolley with front pivoting non-marking wheels (with brake) & large inbuilt accessories basket • Removable motors unit header through metal hooks

TECHNICAL DATA

| | SMV100 3-36 SAH |
|---|--|
| code | 40039-00007 |
| abs. power W | 3300 |
| n°/type motor | 3 x two stages universal |
| max vacuum (actual) | 24 kPa (2400 mmH ₂ O) |
| max Airflow | 510 m ³ /h - 142 l/s |
| container capacity | 100 l |
| noise level | 78 dB(A) |
| voltage | 230 V~50 Hz (1Ph) |
| inlet Ø - type (s=straight; t=tangential) | 60 mm - t |
| filtering capacity/surface | 1 µm - 99,995% (H Class)/ 9000 cm ² |
| cable length | 10 m |
| dimension (cm)/weight | 60x80x147/59 kg |

PLUS



3 double stage silenced motors, suction system with by-pass cooling, liquid float valve and antistatic device



Automatic self-cleaning filter shaker (international copyright): it activates automatically without stopping the vacuum phase



3 cartridge filters in the upper part and ULPA filter in the lower part to offer a structured and complete filtering



Sturdy structure in stove-painted steel with non-marking pivoting front wheels with brake and large inbuilt storage compartment

RECOMMENDED FOR: vacuuming great quantities of dust, it is ideal in road or construction sites. It can feature the LONGOPACK set as optional (code 25001-00640 together with 10001-07796 and 10001-07797) that allows easier emptying of the collected dust.

STANDARD EQUIPMENT

| | | | | |
|---|---|--|--|--|
| <ul style="list-style-type: none"> • 00070-00394 HEPA (H14) + PTFE cartridge filter (3x) | <ul style="list-style-type: none"> • 00009-03441 Quick release adaptor Ø60-50 (1x) | | | |
|---|---|--|--|--|

There isn't any hose or tool provided within the unit.

OPTIONAL

| | | |
|---|---|--|
| <p>Optional minimum set to run the unit:</p> <ul style="list-style-type: none"> • 10001-09372 3m complete EVA Ø50 hose set (1x) | <p>Longpack set:</p> <ul style="list-style-type: none"> • 10001-07796 Hopper for spool bag collection • 10001-07797 Tray for spool bag collection • 25001-00640 Longopack 22m bag spools (box of 4) | <ul style="list-style-type: none"> • 00070-00395 ULPA (H13) D.O.P. cartridge filter |
|---|---|--|

DMX-R 80/DTX-R 80

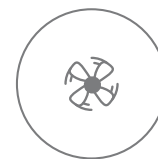

MORE INFO



CHARACTERISTICS

- IP 55 silenced turbine motor • Stainless steel container • Mechanical horizontal & simple manual filter cleaning system • Steel closing hooks • Static electric shock inhibitor • Power coated steel structure and containers • Steering wheels with brake • Liquid float valve • Pressure relief valve, safety device avoiding engine problems in case of clogging • Drain hose system • Quick release tank system

TECHNICAL DATA

| | DMX-R 80 1-22 | DTX-R 80 1-30 |
|---|--|--|
| code | 40034-00001 | 40034-00002 |
| abs. power W | 2200 | 3000 |
| n°/type motor | 1/induction | 1/induction |
| max vacuum (actual) | 21/25 kPa (2100/2500 mmH ₂ O) | 25/32 kPa (2500/3200 mmH ₂ O) |
| max Airflow | 97 l/s | 97 l/s |
| container capacity | 80 l. | 80 l. |
| noise level | 74 dB(A) | 74 dB(A) |
| voltage | 230 V~50 Hz (1Ph) | 400 V~50 Hz (3Ph) |
| inlet Ø - type (s=straight; t=tangential) | 40 mm - s | 40 mm - s |
| filtering capacity/surface | 5 µm/ 4300 cm ² | 5 µm/ 4300 cm ² |
| cable length | 10 m | 10 m |
| dimension (cm)/weight | 47x71x115/70 Kg | 47x71x115/70 Kg |

PLUS



IP 55 silenced turbine motor and pressure relief valve



Filter shaker that keeps the filter clean thanks to a simple manual swing mechanism





Drain hose system for tank easy emptying









Accessories diameter 40 mm

RECOMMENDED FOR: car wash sector

STANDARD EQUIPMENT

| | | | | |
|--|--|--|--|--|
|  <ul style="list-style-type: none"> • Flexible hose ø 40 - 3 m code 00080-04012 |  <ul style="list-style-type: none"> • Flat lance ø 40 code 00080-01931 |  <ul style="list-style-type: none"> • Cloth filter code 00070-00679 | | |
|--|--|--|--|--|

OPTIONAL

| | | | | |
|--|--|---|---|--|
|  <ul style="list-style-type: none"> • Washable filter 10001-08168 |  <ul style="list-style-type: none"> • Kit 10001-09435 | |  <ul style="list-style-type: none"> • 00080-03979 Flex hose 2,5m Ø40 |  <ul style="list-style-type: none"> • 00080-04005 Flex hose 4m Ø40 |
|  <ul style="list-style-type: none"> • 00080-03990 Flex hose 5m Ø40 |  <ul style="list-style-type: none"> • 10001-09446 KIT chromium plated pipe + curved chromium plated pipe Ø 40 mm |  <ul style="list-style-type: none"> • 00080-01932 Roud brush - Ø 40 mm |  <ul style="list-style-type: none"> • 00080-01956 Multipurpose accessories Ø 40 mm - 400 mm • 00080-02015 Multipurpose accessories Ø 40 mm - 300 mm |  <ul style="list-style-type: none"> • 00080-01957 Bristle accessory for dry suction (for floors) 400 mm • 00080-02004 Bristle accessory for dry suction (for floors) 300 mm |
|  <ul style="list-style-type: none"> • 00080-01958 Accessory for wet suction 400 mm • 00080-02005 Accessory for wet suction 300 mm |  <ul style="list-style-type: none"> • 00080-01959 Accessory for carpet 400 mm • 00080-02006 Accessory for carpet 300 mm |  <ul style="list-style-type: none"> • 00014-01444 Flexible hose Ø40 mm - 30 m | | |

DTV100 1-30 SL

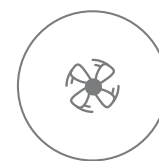

MORE INFO



CHARACTERISTICS

- 1 single stage side channel blower with three-phase induction motor
- Power coated steel structure and containers
- Mechanical horizontal & simple manual filter cleaning system
- Polyester non woven fabric pockets filter, class L
- Metal central inlet channel with deflector
- Wheeled container with inbuilt quick release handle, drain plug and full load level
- Trolley with front pivoting non-marking wheels (with brake) & large inbuilt accessories basket
- Removable motor unit header through metal hooks

TECHNICAL DATA

| | DTV100 1-30 SL |
|---|--|
| code | 40040-00052 |
| abs. power W | 3000 |
| n°/type motor | 1/induction |
| max vacuum (actual) | 32 kPa (2600 mmH ₂ O) |
| max Airflow | 320 m ³ /h - 89 l/s |
| container capacity | 100 l |
| noise level | 78 dB(A) |
| voltage | 400 V~50 Hz (3Ph) |
| inlet Ø - type (s=straight; t=tangential) | 70 mm - s |
| filtering capacity/surface | 2 µm - 99% (L Class)/20000 cm ² |
| cable length | 10 m |
| dimension (cm)/weight | 80x60x171/83 kg - 182 lbs |

PLUS



1 single stage side channel blower with three-phase induction motor



Polyester non woven fabric pocket filter, class L for increased filtering capacity



Filter shaker that keeps the filter clean thanks to a simple manual swing mechanism



Sturdy steel structure with non-marking pivoting front wheels with brake and large inbuilt storage compartment

RECOMMENDED FOR: use in industry sector: it is a very versatile product, thanks to the many optional packs available, it can adapt to the most varied needs. In case of wet suction it is possible to have the float (code 00069-00379 + 00040-01266) and the emptying tap (code 10001-07798) as options.

STANDARD EQUIPMENT

| | | | | |
|--|---|--|--|--|
| <ul style="list-style-type: none"> • 00070-00396 Polyester pockets filter 2m², class L | <ul style="list-style-type: none"> • 00014-02300 Adaptor Ø70-50 (1x) | | | |
|--|---|--|--|--|

There isn't any hose or tool provided within the unit.

OPTIONAL

| | | | | |
|--|--|---|--|--|
| <p>Optional minimum set to run the unit:</p> <ul style="list-style-type: none"> • 10001-09372 3m complete EVA Ø50 hose set (1x) | <p>Longpack set:</p> <ul style="list-style-type: none"> • 10001-07796 Hopper for spool bag collection • 10001-07797 Tray for spool bag collection • 25001-00640 Longpack 22m bag spools (box of 4) | | | <ul style="list-style-type: none"> • 00070-00397 Polyester pockets filter 3m², class L |
| <ul style="list-style-type: none"> • 00070-00398 Antistatic Polyester pockets filter 2m², class M • 00070-00399 Antistatic Polyester pockets filter 3m², class M | <ul style="list-style-type: none"> • 00070-00400 180°C Heatproof polyester pockets filter 2m², class M | <ul style="list-style-type: none"> • 10001-07799 Flat cartridge Hepa secondary filter assembly kit | <ul style="list-style-type: none"> • 00070-00401 Flat cartridge Hepa filter (replacement) | <ul style="list-style-type: none"> • 00040-01266 Galvanized floater support (without floater) |
| <ul style="list-style-type: none"> • 00069-00379 Floater for wet suction | <ul style="list-style-type: none"> • 00042-03611 Wet filter protection cone for floater stop | <ul style="list-style-type: none"> • 10001-07798 Container discharge faucet kit | <ul style="list-style-type: none"> • 00040-01331 Galvanized chip basket including floater | <ul style="list-style-type: none"> • 00042-03611 Wet filter protection cone for floater stop |

DTV100 1-30 OIL

Nylon



MORE INFO

**CHARACTERISTICS**

- 1 single stage side channel blower with three-phase induction motor
- Power coated steel structure and containers.
- Stainless steel AISI 304 submersible electric pump (S1) for liquid (and up to 20mm size mixed waste) automatic discharge.
- Washable nylon filter
- Metal central inlet channel with deflector
- Wheeled container with inbuilt quick release handle, drain plug and full load level
- Trolley with front pivoting non-marking wheels (with brake) & large inbuilt accessories basket
- Removable motor unit header through metal hooks

TECHNICAL DATA

| | DTV100 1-30 OIL |
|---|----------------------------------|
| code | 40040-00053 |
| abs. power W | 3000 |
| n°/type motor | 1/induction |
| max vacuum (actual) | 32 kPa (2600 mmH ₂ O) |
| max Airflow | 320 m ³ /h - 89 l/s |
| container capacity | 100 l |
| noise level | 78 dB(A) |
| voltage | 400V~ 50 Hz (3Ph) |
| inlet Ø - type (s=straight; t=tangential) | 70 mm - s |
| filtering capacity/surface | 3,2 µm/7000 cm ² |
| cable length | 10 m |
| dimension (cm)/weight | 80x60x171 / 83 kg - 182 lbs |

PLUS



1 single stage side channel blower with three-phase induction motor



Washable nylon filter; metal central inlet channel with deflector, ideal for wet suction



Brass submersible electric pump 550 Watt (S1) for liquid (and up to 20 mm size mixed waste) automatic discharge



Sturdy steel structure with non-marking pivoting front wheels with brake and large inbuilt storage compartment

RECOMMENDED FOR: wet suction, ideal for transferring liquids or oil

STANDARD EQUIPMENT

| | | | | |
|---|--|--|--|--|
| <ul style="list-style-type: none"> • 00070-00402 Washable nylon filter 0,7 m² | <ul style="list-style-type: none"> • 00014-02300 Adaptor Ø 70-50 (1x) | | | |
|---|--|--|--|--|

There isn't any hose or tool provided within the unit.

OPTIONAL

| | | | | |
|---|---|---|--|--|
| <p>Optional minimum set to run the unit:</p> <ul style="list-style-type: none"> • 10001-09374 3 m complete PUR Ø 50 hose set (1x) + 00080-01594 Liquid discharge hose & gun Ø 25 mm x 1,8 m | <ul style="list-style-type: none"> • 00070-00399 Antistatic Polyester pockets filter 3m², class M | <ul style="list-style-type: none"> • 00070-00400 180°C Heatproof polyester pockets filter 2 m², class M | <ul style="list-style-type: none"> • 00054-00569 Wheeled 100l container with inbuilt quick release handle, drain plug and full load level | <ul style="list-style-type: none"> • 00070-00397 Polyester pockets filter 3m², class L |
| <ul style="list-style-type: none"> • 10001-07793 Short galvanized chip basket | | | | |

DTV100 1-55 SL

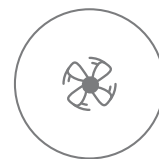

MORE INFO



CHARACTERISTICS

- 1 (parallel) double stage side channel blower with three-phase induction motor
- Power coated steel structure and containers
- Mechanical horizontal & simple manual filter cleaning system
- Polyester non woven fabric pockets filter, class L
- Metal central inlet channel with deflector
- Wheeled container with inbuilt quick release handle, drain plug and full load level
- Trolley with rear pivoting non-marking wheels (with breake) & large inbuilt accessories tray
- Removable top cover header through metal hooks

TECHNICAL DATA

| | DTV100 1-55 SL |
|---|---|
| code | 40040-00055 |
| abs. power W | 5500 |
| n°/type motor | 1/induction |
| max vacuum (actual) | 32 kPa (2600 mmH ₂ O) |
| max Airflow | 560 m ³ /h - 156 l/s |
| container capacity | 100 l |
| noise level | 78 dB(A) |
| voltage | 400 V~50 Hz (3Ph) |
| inlet Ø - type (s=straight; t=tangential) | 70mm - s |
| filtering capacity/surface | 2 µm - 99,9% (L Class)/ 20000 cm ² |
| cable lenght | 10 m |
| dimension (cm)/weight | 100x60x140 / 143 kg - 315 lbs |

PLUS

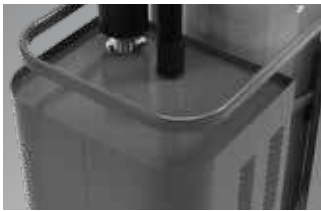

1 parallel double stage side channel blower with three-phase induction motor



Polyester non woven fabric pocket filter, class L for increased filtering capacity



Filter shaker that keeps the filter clean thanks to a simple manual swing mechanism



Sturdy steel structure with non-marking pivoting front wheels with brake and large inbuilt storage compartment

RECOMMENDED FOR: use in industry sector: it is a very versatile product, thanks to the many optional packs available, it can adapt to the most varied needs. It has great airflow and great pressure and can therefore also be used with longer hoses or by two or more operators

STANDARD EQUIPMENT

| | | | | |
|--|---|--|--|--|
| <ul style="list-style-type: none"> • 00070-00396 Polyester pockets filter 2m², class L | <ul style="list-style-type: none"> • 00014-02300 Adaptor Ø70-50 (1x) | | | |
|--|---|--|--|--|

There isn't any hose or tool provided within the unit.

OPTIONAL

| | | | | |
|--|--|---|--|--|
| <p>Optional minimum set to run the unit:</p> <ul style="list-style-type: none"> • 10001-09372 3m complete EVA Ø50 hose set (1x) | <p>Longpack set:</p> <ul style="list-style-type: none"> • 10001-07796 Hopper for spool bag collection • 10001-07797 Tray for spool bag collection • 25001-00640 Longpack 22m bag spools (box of 4) | | | <ul style="list-style-type: none"> • 00070-00397 Polyester pockets filter 3m², class L |
| <ul style="list-style-type: none"> • 00070-00398 Antistatic Polyester pockets filter 2m², class M • 00070-00399 Antistatic Polyester pockets filter 3m², class M | <ul style="list-style-type: none"> • 00070-00400 180°C Heatproof polyester pockets filter 2m², class M | <ul style="list-style-type: none"> • 10001-07799 Flat cartridge Hepa secondary filter assembly kit | <ul style="list-style-type: none"> • 00070-00401 Flat cartridge Hepa filter (replacement) | <ul style="list-style-type: none"> • 00040-01266 Galvanized floater support (without floater) |
| <ul style="list-style-type: none"> • 00069-00379 Floater for wet suction | <ul style="list-style-type: none"> • 00042-03611 Wet filter protection cone for floater stop | <ul style="list-style-type: none"> • 10001-07798 Container discharge faucet kit | <ul style="list-style-type: none"> • 00040-01331 Galvanized chip basket including floater | <ul style="list-style-type: none"> • 00042-03611 Wet filter protection cone for floater stop |

Complete single hose optional configurations sets:

EVA

Conductive, top lightness and flexibility, fluted inside

PU OIL PROOF

Antistatic, oil proof, medium lightness and flexibility, smooth inside

PU OIL & ABRASION PROOF

Antistatic, oil proof, abrasion proof, low lightness and flexibility, smooth inside

| | | SMW100 3-36 SAH | DMX-R 80 1-22 | DTX-R 80 1-30 | DTW100 1-30 SL | DTW1001-30 OIL | DTX100 1-26 SM EX 2-22 | DTW1001-55 SL |
|---|--|--|---------------|---------------|----------------|----------------|------------------------|---------------|
| EVA Ø 50 | | Quantities to be ordered accordingly with machine model | | | | | | |
| 00009-03441 | Adaptor Ø60-50 | 1 | n.a. | n.a. | n.a. | n.a. | 1 | n.a. |
| 00014-02300 | Adaptor Ø70-50 | n.a. | n.a. | n.a. | 1 | 1 | n.a. | 1 |
| 00078-00307 | Stainless steel clamp for hose | 2 | 2 | 2 | 2 | 2 | 2 | 2 |
| 00014-02293 | Conductive coupling for EVA flexible accessory side Ø 50 | 2 | 2 | 2 | 2 | 2 | 2 | 2 |
| 00080-01831 | EVA cond. hose Ø 50 - min 5 m. or mult., max 25 m. | To be ordered by meters, min. 5m or multiple up to 25m max | | | | | | |
| 00009-02990 | joint coupling for flexible Ø50 and accessory coupling Ø50 | 1 | 1 | 1 | 1 | 1 | 1 | 1 |
| PU OIL PROOF Ø 50 | | | | | | | | |
| 00009-03441 | Adaptor Ø60-50 | 1 | n.a. | n.a. | n.a. | n.a. | 1 | n.a. |
| 00014-02300 | Adaptor Ø70-50 | n.a. | n.a. | n.a. | 1 | 1 | n.a. | 1 |
| 00078-00307 | Stainless steel clamp for hose | 2 | 2 | 2 | 2 | 2 | 2 | 2 |
| 00014-02292 | Conductive coupling for PUR/PVC flexible accessory side Ø 50 | 2 | 2 | 2 | 2 | 2 | 2 | 2 |
| 00080-01833 | PUR antist. hose Ø 50 - min 5 m. or mult., max 20 m. | To be ordered by meters, min. 5m or multiple up to 20m max | | | | | | |
| 00009-02990 | joint coupling for flexible Ø50 and accessory coupling Ø50 | 1 | 1 | 1 | 1 | 1 | 1 | 1 |
| PU OIL & ABRASION PROOF Ø 50 | | | | | | | | |
| 00009-03441 | Adaptor Ø60-50 | 1 | n.a. | n.a. | n.a. | n.a. | 1 | n.a. |
| 00014-02300 | Adaptor Ø70-50 | n.a. | n.a. | n.a. | 1 | 1 | n.a. | 1 |
| 00078-00307 | Stainless steel clamp for hose | 2 | 2 | 2 | 2 | 2 | 2 | 2 |
| 00014-02293 | Conductive coupling for EVA flexible accessory side Ø 50 | 2 | 2 | 2 | 2 | 2 | 2 | 2 |
| 00080-01834 | PUR antioil hose Ø 50 - min 5 m. or mult., max 60 m. | To be ordered by meters, min. 5m or multiple up to 60m max | | | | | | |
| 00009-02990 | joint coupling for flexible Ø50 and accessory coupling Ø50 | 1 | 1 | 1 | 1 | 1 | 1 | 1 |

Complete double hoses optional configurations sets:

| EVA Ø 50 (5m) + "Y" + 2 x EVA Ø 40 | | Quantities to be ordered accordingly with machine model | | | | | | |
|--|---|--|------|------|------|------|------|------|
| 00009-03441 | Adaptor Ø60-50 | 1 | n.a. | n.a. | n.a. | n.a. | 1 | n.a. |
| 00014-02300 | Adaptor Ø70-50 | n.a. | n.a. | n.a. | 1 | 1 | n.a. | 1 |
| 00078-00307 | Stainless steel clamp for hose | 2 | 2 | 2 | 2 | 2 | 2 | 2 |
| 00014-02293 | Conductive coupling for EVA flexible accessory side Ø 50 | 2 | 2 | 2 | 2 | 2 | 2 | 2 |
| 00080-01831 | EVA cond. hose Ø 50 - min 5 m. or mult., max 25 m. | 5 | 5 | 5 | 5 | 5 | 5 | 5 |
| 00009-02991 | Double steel coupling | 1 | 1 | 1 | 1 | 1 | 1 | 1 |
| 00078-00307 | Stainless steel clamp for hose | 4 | 4 | 4 | 4 | 4 | 4 | 4 |
| 00014-02298 | Conductive coupling for EVA flexible Ø 38 - accessory side Ø 50 | 4 | 4 | 4 | 4 | 4 | 4 | 4 |
| 00080-01830 | EVA cond. Hose Ø 38 - min 5 m. or mult., max 30 m. | To be ordered by meters, min. 5m or multiple up to 30m max | | | | | | |
| PU OIL PROOF Ø50 (5m) + "Y" + 2x PU OIL PROOF Ø40 | | | | | | | | |
| 00009-03441 | Adaptor Ø60-50 | 1 | n.a. | n.a. | n.a. | n.a. | 1 | n.a. |
| 00014-02300 | Adaptor Ø70-50 | n.a. | n.a. | n.a. | 1 | 1 | n.a. | 1 |
| 00078-00307 | Stainless steel clamp for hose | 2 | 2 | 2 | 2 | 2 | 2 | 2 |
| 00014-02293 | Conductive coupling for EVA flexible accessory side Ø 50 | 2 | 2 | 2 | 2 | 2 | 2 | 2 |
| 00080-01833 | PUR antist. hose Ø 50 - min 5 m. or mult., max 20 m. | 5 | 5 | 5 | 5 | 5 | 5 | 5 |
| 00009-02991 | Double steel coupling | 1 | 1 | 1 | 1 | 1 | 1 | 1 |
| 00078-00307 | Stainless steel clamp for hose | 4 | 4 | 4 | 4 | 4 | 4 | 4 |
| 00014-02294 | Conductive coupling for PUR flexible accessory side Ø 40 | 4 | 4 | 4 | 4 | 4 | 4 | 4 |
| 00080-01832 | PUR antist. hose Ø 40 - min 5 m. or mul., max 20 m. | To be ordered by meters, min. 5m or multiple up to 20m max | | | | | | |
| Ø40 Tools for double hoses optional configurations sets | | | | | | | | |
| 00080-01602 | Ø 40 - steel flat lance mm 500 | 2 | 2 | 2 | 2 | 2 | 2 | 2 |
| 00080-01931 | Ø 40 - PVC flat lance | 2 | 2 | 2 | 2 | 2 | 2 | 2 |
| 00080-01932 | Ø 40 - PVC round brush | 2 | 2 | 2 | 2 | 2 | 2 | 2 |

Optional accessories Ø 50 mm

| | | SMV100 3-36 SAH | DTV100 1-30 SL | DTV100 1-30 OIL | DTX100 1-26 SM Ex 2-22 | DTV100 1-55 SL |
|---|---|-----------------|----------------|-----------------|------------------------|----------------|
|  | 00014-02298 Rubber sleeve for hose Ø 38 | ○ | ○ | ○ | ○ | ○ |
| | 00014-02292 Antistatic rubber sleeve for hose Ø 50 | ○ | ○ | ○ | ○ | ○ |
| | 00014-02293 Rubber sleeve for hose Ø 50 | ○ | ○ | ○ | ○ | ○ |
|  | 00080-01830 EVA CONDUCTIVE Ø 38 - min 5 mt or multiple, max 30 mt. | ○ | ○ | ○ | ○ | ○ |
| | 00080-01831 EVA CONDUCTIVE Ø 50 - min 5 mt or multiple, max 30 mt. | ○ | ○ | ○ | ○ | ○ |
|  | 00080-01833 PUR ANTISTATIC Ø 50 - min 5 mt or multiple, max 30 mt. | ○ | ○ | ○ | ○ | ○ |
|  | 00080-01834 PUR OILPROOF Ø 50 - min 5 mt or multiple, max 30 mt. | ○ | ○ | ○ | ○ | ○ |
|  | 00078-00307 Steel clamps for rubber sleeve Ø 50/Ø 38 | ○ | ○ | ○ | ○ | ○ |
|  | 00009-02990 Steel connection with button Ø 50/Ø 38 - accessory side | ○ | ○ | ○ | ○ | ○ |
|  | 00026-01129 Ø 50 - steel double curve with joint coupling | ○ | ○ | ○ | ○ | ○ |
|  | 00080-01585 Ø 50 - steel extension with joint coupling | ○ | ○ | ○ | ○ | ○ |
|  | 00080-01586 Ø 50 - steel flat lance mm 500 | ○ | ○ | ○ | ○ | ○ |
|  | 00080-01592 Ø 50 - antistatic rubber conic bend lance | ○ | ○ | ○ | ○ | ○ |
|  | 00080-01593 Ø 50 - antistatic rubber conic lance | ○ | ○ | ○ | ○ | ○ |
|  | 00080-01587 Ø 50 - antistatic rubber round lance | ○ | ○ | ○ | ○ | ○ |
|  | 10001-07791 Ø 50 - antistatic rubber suction lance | ○ | ○ | ○ | ○ | ○ |
|  | 00080-04097 Ø 50 - stainless steel accessory for dust suction with wheels | ○ | ○ | ○ | ○ | ○ |
|  | 00080-04098 Ø 50 - stainless steel accessory for wet suction with wheels | ○ | ○ | ○ | ○ | ○ |
|  | 00080-01589 Ø 50 - PVC flat lance | ○ | ○ | ○ | ○ | ○ |
|  | 00080-01590 Ø 50 - PVC round brush | ○ | ○ | ○ | ○ | ○ |

○ = optional

Accessories

| | | | SMX-R 80 3-36S DS | SMV100 3-36 SAH | DTV100 1-30 SL | DTV100 1-30 OIL | DTX100 1-26 SM Ex 2-22 | DTV100 1-55 SL |
|---|-------------|---|-------------------|-----------------|----------------|-----------------|------------------------|----------------|
|  | 00040-01266 | floating galvanized basket | | | ○ | | ○ | ○ |
|  | 00069-00379 | floater (in combination with 00040-01266) | | | ○ | | ○ | ○ |
|  | 10001-07792 | galvanized chip basket (in combination with 00054-00569) | | | ○ | | ○ | ○ |
| | 00040-01331 | galvanized chip basket including floater | | | | ○ | ○ | |
|  | 00080-01594 | liquids expulsion lance with gun Ø 25 x 1,8 m | | | | ○ | | |
|  | 00014-02301 | steel joint coupling Ø 50 | ○ | ○ | ○ | ○ | ○ | ○ |
| | 00014-02303 | steel joint coupling Ø 40 | | | | | | |
|  | 10001-07798 | Container discharge faucet kit | | | ○ | | ○ | ○ |
|  | 10001-07793 | stainless steel chip basket for tank with pump | | | | ○ | | |
| | 10001-07792 | stainless steel chip basket | ○ | | | | | |
| | 00040-01251 | stainless steel chip basket | ○ | | | | | |
|  | 00071-05507 | steel cyclone cone | ○ | | | | | |
| | 00042-03611 | Wet filter protection plastic cone for floater stop | | | ○ | | ○ | ○ |
|  | 00066-00009 | steel reduction Ø mm 70-40 | ○ | | | | | |
| | 00066-00010 | steel reduction Ø mm 70-50 | | | | | | |
| | 00014-02300 | adaptor Ø mm 70-50 | S | | S | S | | ○ |
| | 00009-03441 | adaptor Ø mm 60-50 | | ○ | | ○ | | |
|  | 00080-01601 | "L" steel pipe Ø 50 L 1200 | ○ | | | | | |
|  | 00014-02305 | nylon oven coupling | ○ | | | | | |

○ = optional

Accessories

| | | | SMX-R 80 3-36S DS | SMV100 3-36 SAH | DTV100 1-30 SL | DTV100 1-30 OIL | DTX100 1-26 SM Ex 2-22 | DTV100 1-55 SL |
|---|-------------|---|-------------------|-----------------|----------------|-----------------|------------------------|----------------|
|  | 10001-07796 | hopper for spool bag collection | | ○ | ○ | | ○ | ○ |
|  | 10001-07797 | Tray for spool bag collection | | ○ | ○ | | ○ | ○ |
|  | 25001-00640 | Longopack 22m bag spools (box of 4) | | ○ | ○ | | ○ | ○ |
|  | 00070-00406 | heat resistant oven filter | ○ | | | | | |
| | 00070-00407 | teflon filter | ○ | | | | | |
| | 00070-00679 | cloth filter | S | | | | | |
| | 00070-00402 | washable nylon filter 0,7m ² 300µm | | | S | | | |
|  | 00070-00396 | Polyester pockets filter 2m ² , class L | | S | | | | S |
| | 00070-00398 | Antistatic Polyester pockets filter 2m ² , class M | | ○ | | S | ○ | |
| | 00070-00400 | 180°C Heatproof polyester pockets filter 2m ² , class M | | ○ | ○ | ○ | ○ | |
|  | 00070-00397 | Polyester pockets filter 3m ² , class L | | ○ | ○ | | ○ | |
| | 00070-00399 | Antistatic Polyester pockets filter 3m ² , class M | | ○ | ○ | ○ | ○ | |
|  | 10001-07799 | Flat cartridge Hepa secondary filter assembly kit | | ○ | | | ○ | ○ |
|  | 00070-00401 | Flat cartridge Hepa filter (replacement) | | ○ | | | ○ | ○ |
|  | 00054-00569 | Wheeled 100 l container with inbuilt quick release handle, drain plug and full load level | | | ○ | | | |
|  | 00070-00394 | HEPA (H14) + PTFE cartridge filter | | S | | | | |
| | 00070-00395 | ULPA (H13) D.O.P. cartridge filter | | ○ | | | | |

S = standard equipment ○ = optional

Which are key components in a single disc machine?

The procedure to choose the right product for specific application must take into consideration of: the weight (that is the pressure over the brush), the surface to work, the RPM / type of construction of the motor and the transmission type. Generally speaking, the lower is the rotation speed, the most effective is the pressure over the brush and deeper is dirt removal. With the increasing of rotation speed, lower is the effect of the pressure over the floor. Different accessories combinations, rotation speed and motor power can provide the solution for any application: from dewaxing or deep scrub, up to polishing or buffing; from the crystallization up to spray cleaning; also carpet cleaning or sanding. Please see application chapter on the next pages.



How much power is necessary?

There is not a set rule, if not the common sense: higher is the friction over the floor (a combination of type of working, type of surface and type of accessory used), the higher will be the power request to the motor. So more powerful is the motor, the harder the job being able to be done.

The power is nothing without control....

Together with its construction simplicity there are the worst danger for the operator who has to control the machine for long working sessions. Only the perfect components and weights distribution on the machine allows a perfect balanced and ergonomic working posture, without any vibration and any strange effort to keep it in place. A cheap construction (less strength) not considering the perfect ergonomic for the user, further to the waste of money (less productivity), it's a serious danger for the health!

Application

| | Page | Code | Ø brush | Stripping synthetic floor (PVC) | Stripping cork present floor (linoleum) | Wet scrubbing/basic cleaning of stones, tiles and lino (sensitive floors) | Wet scrubbing/basic cleaning of synthetic or non sensitive floors pvc | Crystallizing | Carpet shampooing | Sanding wood | Sanding cement | Spray polishing and buffing |
|---------------------------|------|-------------|-----------|---------------------------------|---|---|---|---------------|-------------------|--------------|----------------|-----------------------------|
| SDM-R 45 G 16-130 | 224 | 46001-00027 | 430 - 17" | • | • | • | • | • | • | • | | |
| SDM-R 45 G 16-160 | 224 | 46001-00028 | 430 - 17" | • | • | • | • | • | • | | • | |
| SDM-R 45 G 16-180 | 224 | 46001-00029 | 430 - 17" | • | • | • | • | • | • | | | |
| SDM-R 53 G 150-130 | 226 | 46001-00030 | 510 - 20" | | | | | | | | | • |



- **Brush speed**

Means Rotation Per Minute of the brush.



- **Constant brush pressure**

The pressure of brushes on the floor is made by the heavy brush plate that follows irregularity on the floor and gives always the top pressure without any adjustment still with shorter bristles.

Applications pads



MICROFIBER PAD - Ideal for "gres & porcelain" and carpet/moquette if used with dried foam shampoo.

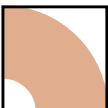

BEIGE PAD - POLISHING - Polyester To polish all kinds of floor. Use dry.



GREEN PAD - INTERMEDIATE CLEANING ACTION - Nylon To remove all the old superficial wax, rests, obtaining ready floors to be recoated. Use wet.



BLACK PAD - WET STRIPPING - Nylon For wet stripping of heavy layers of wax. Ideal to remove old floor finish scu and cement marks.

SDM-R 45 G

↑
BRUSH
NOT INCLUDED



MORE INFO

**CHARACTERISTICS**

- Complete range of single disc machines professional, sturdy, manageable, practical and simple to use.
- Ergonomic handle with integrated safety controls.
- Strong handle joint.
- Powerful and noiseless motor.
- Adapted in order to satisfy all the cleaning requirements, marble restoration and treatment and natural stones, woods and parquet, moquette, dewaxing, hard scrubbing.

TECHNICAL DATA

| | SDM-R 45G 16-130 | SDM-R 45G 16-160 | SDM-R 45G 16-180 |
|-------------------------|------------------------|------------------------|------------------------|
| code | 46001-00027 | 46001-00028 | 46001-00029 |
| type | low speed | low speed | low speed |
| brush speed | 165 RPM | 165 RPM | 165 RPM |
| scrubbing width | 430 mm | 430 mm | 430 mm |
| voltage | 230V / 50HZ | 230V / 50HZ | 230V / 50HZ |
| abs. power | 1300 W | 1600 W | 1800 W |
| transmission | | | helical gear system |
| brush contact pressure | 40,8 g/cm ² | 41,3 g/cm ² | 44,3 g/cm ² |
| noise level | 60 dB(A) | 60 dB(A) | 60 dB(A) |
| cable lenght | 12 m | 12 m | 12 m |
| body height | 280 mm | 280 mm | 280 mm |
| dimension (cm) / weight | 54,2x42,5x120/35 Kg | 54,2x42,5x120/41 Kg | 54,2x42,5x120/52 Kg |

PLUS



Ergonomic handle with integrated safety controls



Powerful and noiseless motor



Helical gear system granting continuous power, long life and noiselessness of the machine



Strong handle joint

Accessories and brushes are not included. For available accessories refer to accessories below.

OPTIONAL

| | | | | |
|--|---|--|--|---|
| <ul style="list-style-type: none"> • 00054-00587 Tank 10 l |  <ul style="list-style-type: none"> • 00080-04121 carpet brush |  <ul style="list-style-type: none"> • 00080-04114 scrubbing brush pp 0,6 |  <ul style="list-style-type: none"> • 00080-04111 tynex brush |  <ul style="list-style-type: none"> • 00080-03128 EWU pad holder |
|  <ul style="list-style-type: none"> • 00080-03124 Abrasive disc holder |  <ul style="list-style-type: none"> • 00080-03132 carborundum disc |  <ul style="list-style-type: none"> • 10001-10770 Pad microfiber 5 pcs |  <ul style="list-style-type: none"> • 10001-09937 Pad red 5 pcs |  <ul style="list-style-type: none"> • 10001-09918 Pad green 5 pcs |
|  <ul style="list-style-type: none"> • 10001-09923 Pad black 5 pcs |  <ul style="list-style-type: none"> • 10001-10769 Pad silver inox 5 pcs |  <ul style="list-style-type: none"> • 00080-01628 Emery paper GR24 disc |  <ul style="list-style-type: none"> • 00080-01629 Emery paper GR60 disc |  <ul style="list-style-type: none"> • 00080-03130 Vidia disc GR24 |
|  <ul style="list-style-type: none"> • 00080-03131 Vidia disc GR36 | | | | |

SDM-R 53 G

MORE INFO

**CHARACTERISTICS**

- Professional ultra-highspeed and high efficiency single disc machine ideal for polishing whichever type of natural or treated with metalized waxes floors (brush not included).
- Ergonomic handle with integrated controls and sturdy joint.
- Powerful and quiet motor.
- Vacuum system. Including a paper collector bag (5 pcs set optional, code 00070-00422).
- Flexible disc holder counterbalancing eventual unevenness

TECHNICAL DATA

| | SDM-R 53G 150-130 |
|------------------------|---------------------------------|
| code | 46001-00030 |
| type | High speed |
| brush speed | 1500 RPM |
| scrubbing width | 510 mm |
| voltage | 230V/50HZ |
| abs. power | 1300 W |
| transmission | direct belt transmission |
| brush contact pressure | 22 g/cm ² adjustable |
| noise level | 56 dB(A) |
| cable length | 12 m |
| body height | 280 mm |
| dimensions / weight | 88 x 55 h 125 cm/48,8 Kg |

PLUS



Ergonomic handle with integrated safety controls



Strong handle joint



Flexible disc-holder counterbalancing eventual unevenness (disc not included)







Vacuum system, including a paper collector bag

Brushes are not included. For available accessories refer to accessories below.



OPTIONAL

| | | | | |
|--|--|--|--|--|
| <ul style="list-style-type: none"> • 00070-00422 Paper collector bag (5 pcs). |  <ul style="list-style-type: none"> • 10001-07815 Abrasive disc. blue with pad holder included | | | |
|--|--|--|--|--|

Application

| Description | Code | Models | Stripping synthetic floor (PVC) | Stripping cork present floor (linoleum) | Wet scrubbing/basic cleaning of stones, tiles and lino (sensitive floors) | Wet scrubbing/basic cleaning of synthetic or non sensitive floors pvc | Crystallizing | Carpet shampooing | Sanding wood | Sanding cement | Spray cleaning | Spray polishing and buffing |
|---|-------------|-----------|---------------------------------|---|---|---|---------------|-------------------|--------------|----------------|----------------|-----------------------------|
| Brushes (*) | | | | | | | | | | | | |
|  Carpet brush | 00080-04121 | SDM-R 45G | | | | | | x | | | | |
|  Scrubbing brush PP 0,6 mm | 00080-04114 | SDM-R 45G | | x | x | | | | | | | |
|  Tynex brush | 00080-04111 | SDM-R 45G | x | | | x | | | | | | |
| Pad Holder | | | | | | | | | | | | |
|  EWU pad holder | 00080-03128 | SDM-R 45G | x | x | x | x | x | | | x | x | |
|  Abrasive Disc Holder | 00080-03124 | SDM-R 45G | | | | | | | x | x | | |
| Abrasive disc. blue with pad holder included | 10001-07815 | SDM-R 53G | | | | | | | | | | x |



| Description | Code | Models | Stripping synthetic floor (PVC) | Stripping cork present floor (linoleum) | Wet scrubbing/basic cleaning of stones, tiles and lino (sensitive floors) | Wet scrubbing/basic cleaning of synthetic or non sensitive floors, pvc | Crystallizing | Carpet shampooing | Sanding wood | Sanding cement | Spray cleaning | Spray polishing and buffing |
|---|-------------|-----------|---------------------------------|---|---|--|---------------|-------------------|--------------|----------------|----------------|-----------------------------|
| Special Disc | | | | | | | | | | | | |
|  Carborundum disc | 00080-03132 | SDM-R 45G | | | | | | | | x | | |
| Pads | | | | | | | | | | | | |
|  Pad micro fiber 5 pcs | 10001-10770 | SDM-R 45G | | | | | x | | | | | |
| Pad red 5 pcs | 10001-09937 | SDM-R 45G | | | x | | | | | | x | |
| Pad green 5 pcs | 10001-09918 | SDM-R 45G | | x | | x | | | | | | |
| Pad black 5 pcs | 10001-09923 | SDM-R 45G | x | | | | | | | | | |
| Pad silver Inox 5 pcs | 10001-10769 | SDM-R 45G | | | | | x | | | | | |
| Emery paper GR24 disc | 00080-01628 | SDM-R 45G | | | | | | | x | | | |
| Emery paper GR60 disc | 00080-01629 | SDM-R 45G | | | | | | | x | | | |
| Vidia disc GR24 | 00080-03130 | SDM-R 45G | | | | | | | | x | | |
| Vidia disc GR36 | 00080-03131 | SDM-R 45G | | | | | | | | x | | |

X = suitable





Direct experience of professional people has resulted in LAVOR floor scrubbers range: easy to handle, powerful, efficient, carefully conceived and designed by using top-quality materials.

Why cilindric brush?

High speed rotation for a polishing effect; great dirt degrease in floors with grout ; possibility to link together the sweeping function; the rotation direction assists forwarding in models without traction.

Why disc brush?

Extended mechanical action of the bristles on the floor, ideal for persistent dirt: the special setting of the brush plate allows a balanced gripping effect, assisting easy use in the non traction models. Complete cleaning also next to walls is possible and the compact washing element lower at the sides is studied to scrub also under edges.

How a squeegee should be designed?

The shape and the material used grant a perfect drying in every condition, also on floors with grout or when quick U turns are necessary. The floating body can stay in the machine operating space (compact/room saving) The manual adjusting system grants a perfect drying on each kind of floors.

How long do battery charges last?

It is impossible to determine exactly how long a battery charge lasts and so how long a machine can work in autonomy.

Battery autonomy changes depending on type of surface, dirt quantity, brush type and way in which traction system is used (speed and slope).

Battery life is made up of number of charge cycles (also incomplete), if usage conditions, charging and service are perfectly observed.

Manufacturing technology diversifies numbers of cycles, service needed, usage/charging conditions and performances.



• **Number of disc brushes**

The scrubbing group meets different cleaning path need with 1, 2 or 3 disc brushes.



• **Number of cilindric brushes**

Scrubbing group offer 1 or 2 roller brush solutions together with the sweeping capability. Bristles of different material allows perfect cleaning in any conditions, (carpet and parquet included).



• **Cilindric brush quick connection and release:**

The fittings and releasing of brushes is toolless. Ordinary cleaning maintenance are simple and quick for anybody.



• **Solenoid valve**

Together with the reliable mechanical solution faucet, this system reduce chemical consumption and avoid solution waste. The flow is open only when brush is working, there is no accidental leak with machine stopped. The system is protected by a filter with easy maintenance.



• **Integrated battery charger**

Some models are equipped with integrated battery charger, other ones have the predisposition only. It is possible to charge batteries in different rooms, without coming back to the same place.



• **Integrated battery**

Standard integrated battery is built with a maintenance free technology and it does not require restrictions about the place for battery charging. The non stop research allow to use always up-to-date batteries that combined with appropriate battery charger grant machine top performances.



• **Hour meter**

This device allows you to control work sessions (of the machine and the operator) and correctly plan stops to recharge the batteries or maintain the machines. Maximum productivity and investment protection.



• **Lithium batteries as standard**

They provide more power, longer life and much faster charging times.

They are not affected by the memory effect and are lighter in weight with lower maintenance costs.



• **Charge meter and battery protection**

It informs when the autonomy is finishing , allowing the end of the cleaning task (stopping brushes first and then the rest). It prevents damages to the batteries, preventing the complete discharge with any kind of technologies.



• **Eco Energy System**

no-stop and separate control of water quantity and chemical product concentration with automatic and delayed stop of the supply when the machine stops (Automatic Detergent Measuring System).

Applications pads

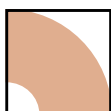

BEIGE PAD - POLISHING
Polyester To polish all kinds of floor. Use dry.



GREEN PAD - INTERMEDIATE CLEANING ACTION - Nylon To remove all the old superficial wax, rests, obtaining ready floors to be recoated. Use wet.



BLACK PAD - WET STRIPPING - Nylon For wet stripping of heavy layers of wax. Ideal to remove old floor finish scu and cement marks.

Nomenclature

Model

Next EVO 66 BTA Li

Scrubbing width

E = ELECTRIC
 B = BATTERY
 BT = BATTERY with TRACTION
 Li = LI-ION BATTERY
 A = Automatic brush plate lifting for walk behind

Technical information

| Code | Model | Page | Power supply | Brushes | Scrubbing width | Squeegee width | Max working capacity | Solution tank capacity | Recovery tank capacity | Packaging | Weight | Weight | pcs x pallet |
|-------------|----------------|------|--------------|---------|-----------------|----------------|--|------------------------|------------------------|---------------------------|--------|--------|--------------|
| | | | V | n° | mm | mm | m ² /h - ft ² /h | l/gal | l/gal | L x l x H cm/inc | kg | lbs | n° |
| 37021-00002 | Sprinter | 234 | 230V/50HZ | 1 | 290 | 320 | 1015-10925 | 2,8/0,74 | 5,6/1,48 | 119X40X37/46x16x14 | 17 | 37 | 10 |
| 37021-00004 | Crystal Clean | 236 | 230V/50HZ | 1 | 290 | 320 | 1015-10925 | 2,8/0,74 | 5,6/1,48 | 119X40X37/46x16x14 | 19 | 42 | 10 |
| 37024-00001 | Fit 35 B Li | 238 | 25,2V | 1 | 390 | 422 | 1500-16145 | 1,9/0,5 | 1,5/0,39 | 53x49x29,5/20,8x19,2x11,6 | 11,3 | 24 | 24 |
| 47001-00001 | Ready 32B Li | 240 | 36V | 2 | 320 | 340 | 1500-16145 | 3,5/0,92 | 6,0/1,59 | 65x51x36/25,5x20x14 | 18 | 39 | 8 |
| 37004-00004 | Quick 36E | 242 | 230V/50HZ | 1 | 360 | 460 | 1260-13562 | 11/2,91 | 12/3,17 | 81x56x80/32x22x32 | 62 | 135 | 1 |
| 37004-00003 | Quick 36B | 242 | 12V | 1 | 360 | 460 | 1260-13562 | 11/2,91 | 12/3,17 | 81x56x80/32x22x32 | 70 | 154 | 1 |
| 37004-00077 | Quick 36B Li | 242 | 12V | 1 | 360 | 460 | 1260-13562 | 11/2,91 | 12/3,17 | 81x56x80/32x22x32 | 42 | 92 | 1 |
| 37012-00031 | Dart 36E | 244 | 230V/50HZ | 1 | 360 | 460 | 1260-13562 | 15/3,96 | 16/4,23 | 98x47x78 /39x19x31 | 79 | 174 | 1 |
| 37012-00032 | Dart 36B | 244 | 24V | 1 | 360 | 460 | 1260-13562 | 15/3,96 | 16/4,23 | 98x47x78 /39x19x31 | 56 | 147 | 1 |
| 37012-00033 | Dart 36B | 244 | 24V | 1 | 360 | 460 | 1260-13562 | 15/3,96 | 16/4,23 | 98x47x78 /39x19x31 | 80 | 231 | 1 |
| 37012-00049 | Dart 38B Li | 244 | 24V | 1 | 380 | 460 | 1260-13562 | 15/3,96 | 16/4,23 | 98x47x78 /39x19x31 | 63 | 138 | 1 |
| 37011-00051 | Dynamic 45E | 246 | 230V/50HZ | 1 | 450 | 540 | 1500-16145 | 30/7,9 | 35/9,24 | 117x58x78/46x22x30 | 88 | 194 | 1 |
| 37011-00052 | Dynamic 45B | 246 | 24V | 1 | 450 | 540 | 1500-16145 | 30/7,9 | 35/9,24 | 117x58x78/46x22x30 | 74 | 163 | 1 |
| 37011-00053 | Dynamic 45B | 246 | 24V | 1 | 450 | 540 | 1500-16145 | 30/7,9 | 35/9,24 | 117x58x78/46x22x30 | 112 | 247 | 1 |
| 37011-00079 | Dynamic 45B Li | 246 | 24V | 1 | 450 | 540 | 1500-16145 | 30/7,9 | 35/9,24 | 117x58x78/46x22x30 | 77,5 | 170 | 1 |
| 37031-00003 | Free EVO 50E | 248 | 230V/50HZ | 1 | 500 | 800 | 2000-21527 | 44/11,63 | 50/13,21 | 125x57x116/49,5x22,5x46 | 117 | 258 | 1 |
| 37031-00104 | Free EVO 50B | 248 | 24V | 1 | 500 | 800 | 2000-21527 | 44/11,63 | 50/13,21 | 125x57x116/49,5x22,5x46 | 83 | 183 | 1 |
| 37031-00001 | Free EVO 50B | 248 | 24V | 1 | 500 | 800 | 2000-21527 | 44/11,63 | 50/13,21 | 125x57x116/49,5x22,5x46 | 84 | 187 | 1 |
| 37031-00013 | Free EVO 50B | 248 | 24V | 1 | 500 | 800 | 2000-21527 | 44/11,63 | 50/13,21 | 125x57x116/49,5x22,5x46 | 138 | 304 | 1 |
| 37031-00105 | Free EVO 50BT | 248 | 24V | 1 | 500 | 800 | 2000-21527 | 44/11,63 | 50/13,21 | 125x57x116/49,5x22,5x46 | 87 | 187 | 1 |
| 37031-00002 | Free EVO 50BT | 248 | 24V | 1 | 500 | 800 | 2000-21527 | 44/11,63 | 50/13,21 | 125x57x116/49,5x22,5x46 | 88 | 191 | 1 |
| 37031-00016 | Free EVO 50BT | 248 | 24V | 1 | 500 | 800 | 2000-21527 | 44/11,63 | 50/13,21 | 125x57x116/49,5x22,5x46 | 142 | 313 | 1 |



| Code | Model | Page | Power supply | Brushes | Scrubbing width | Squeegee width | Max working capacity | Solution tank capacity | Recovery tank capacity | Packaging | Weight | Weight | pcs x pallet |
|-------------|----------------------------|------|--------------|---------|-----------------|----------------|----------------------|------------------------|------------------------|----------------------|--------|--------|--------------|
| | | | V | n° | mm | mm | m²/h - ft²/h | l/gal | l/gal | L x l x H cm/inc | kg | lbs | n° |
| 37033-00002 | Moving 55 E | 250 | 230V/50HZ | 1 | 550 | 800 | 2000-21527 | 55/14,52 | 60/16 | 127x65x117/50x25x46 | 99 | 218 | 1 |
| 37033-00003 | Moving 55 B | 250 | 24V | 1 | 550 | 800 | 2000-21527 | 55/14,52 | 60/16 | 127x65x117/50x25x46 | 99 | 218 | 1 |
| 37033-00004 | Moving 55 B | 250 | 24V | 1 | 550 | 800 | 2000-21527 | 55/14,52 | 60/16 | 127x65x117/50x25x46 | 100 | 220 | 1 |
| 37033-00005 | Moving 55 B | 250 | 24V | 1 | 550 | 800 | 2000-21527 | 55/14,52 | 60/16 | 127x65x117/50x25x46 | 155 | 341 | 1 |
| 37033-00001 | Moving 55 BT | 252 | 24V | 1 | 550 | 800 | 2000-21527 | 55/14,52 | 60/16 | 127x65x117/50x25x46 | 108 | 238 | 1 |
| 37033-00006 | Moving 55 BT | 252 | 24V | 1 | 550 | 800 | 2000-21527 | 55/14,52 | 60/16 | 127x65x117/50x25x46 | 109 | 240 | 1 |
| 37033-00007 | Moving 55 BT | 252 | 24V | 1 | 550 | 800 | 2000-21527 | 55/14,52 | 60/16 | 127x65x117/50x25x46 | 164 | 361 | 1 |
| 37033-00008 | Moving 55 BT | 252 | 24V | 1 | 550 | 800 | 2000-21527 | 55/14,52 | 60/16 | 127x65x117/50x25x46 | 164 | 361 | 1 |
| 37027-00089 | Next EVO 55BT | 254 | 24V | 1 | 550 | 800 | 2200-24210 | 55/14,52 | 65/17,17 | 142x72x123/56x28x48 | 133 | 293 | 1 |
| 37027-00101 | Next EVO 55BT | 254 | 24V | 1 | 550 | 800 | 2200-24210 | 55/14,52 | 65/17,17 | 142x72x123/56x28x48 | 133 | 293 | 1 |
| 37027-00090 | Next EVO 66BTA | 254 | 24V | 2 | 660 | 800 | 2640-28416 | 55/14,52 | 65/17,17 | 142x72x123/56x28x48 | 138 | 304 | 1 |
| 37027-00102 | Next EVO 66BTA | 254 | 24V | 2 | 660 | 800 | 2640-28416 | 55/14,52 | 65/17,17 | 142x72x123/56x28x48 | 138 | 304 | 1 |
| 37002-00093 | Easy-R 55BT | 256 | 24V | 2 | 550 | 800 | 2475-26640 | 67/17,70 | 77/20,35 | 142x72x123/56x28x48 | 127 | 279 | 1 |
| 37002-00101 | Easy-R 66BT | 256 | 24V | 2 | 660 | 800 | 2970-31968 | 67/17,70 | 77/20,35 | 142x72x123/56x28x48 | 122 | 268 | 1 |
| 37003-00010 | Midi-R 75BT | 258 | 24V | 2 | 750 | 900 | 4275-46015 | 88/23,25 | 91/24,04 | 156x74x128/61x29x50 | 180 | 396 | 1 |
| 37010-00052 | Comfort XXS 66 | 260 | 24V | 2 | 660 | 855 | 3250-34982 | 75/19,81 | 80/21,13 | 140x82x135/56x33x53 | 175 | 390 | 1 |
| 37010-00053 | Comfort XXS 66 | 260 | 24V | 2 | 660 | 855 | 3250-34982 | 75/19,81 | 80/21,13 | 140x82x135/56x33x53 | 247 | 544 | 1 |
| 37010-00060 | Comfort XXS 66 | 260 | 24V | 2 | 660 | 855 | 3250-34982 | 75/19,81 | 80/21,13 | 140x82x135/56x33x53 | 177 | 394 | 1 |
| 37010-00075 | Comfort XXS 66 UP | 262 | 24V | 2 | 660 | 855 | 3250-34982 | 75/19,81 | 80/21,13 | 140x82x135/56x33x53 | 177 | 394 | 1 |
| 37010-00079 | Comfort XXS 66 UP | 262 | 24V | 2 | 660 | 855 | 3250-34982 | 75/19,81 | 80/21,13 | 140x82x135/56x33x53 | 177 | 394 | 1 |
| 37010-00076 | Comfort XXS 66 UP Li | 262 | 24V | 2 | 660 | 855 | 3250-34982 | 75/19,81 | 80/21,13 | 140x82x135/56x33x53 | 177 | 394 | 1 |
| 37006-00068 | Comfort XS-R1 75 Essential | 264 | 24V | 2 | 750 | 900 | 4350-46823 | 110/29,06 | 130/34,34 | 152x97x154/59x39x61 | 217 | 478 | 1 |
| 37006-00070 | Comfort XS-R1 85 Essential | 264 | 24V | 2 | 750 | 900 | 5000-53819 | 110/29,06 | 130/34,34 | 152x97x154/59x39x61 | 222 | 489 | 1 |
| 37006-00080 | Comfort XS-R1 75 UP | 266 | 24V | 2 | 750 | 900 | 4350-46823 | 110/29,06 | 130/34,34 | 152x97x154/59x39x61 | 223 | 491 | 1 |
| 37006-00082 | Comfort XS-R1 85 UP | 266 | 24V | 2 | 820 | 1000 | 5000-53819 | 110/29,06 | 130/34,34 | 152x97x154/59x39x61 | 229 | 504 | 1 |
| 37007-00025 | Comfort SR 100 | 268 | 36V | 2 | 1000 | 1000 | 6800-73194 | 140/36,99 | 150/39,63 | 200x118x171/79x46x67 | 300 | 661 | 1 |
| 37007-00027 | Comfort SR 100 UP | 268 | 36V | 2 | 1000 | 1000 | 6800-73194 | 140/36,99 | 150/39,63 | 200x118x171/79x46x67 | 320 | 705 | 1 |
| 37009-00005 | Comfort M102 | 270 | 36V | 2 | 1020 | 1250 | 7140-76854 | 200/52,84 | 210/55,48 | 200x118x171/79x46x67 | 386 | 850 | 1 |
| 37005-00002 | Comfort L122 | 272 | 36V | 3 | 1220 | 1450 | 8540-91923 | 280/73,97 | 315/83,22 | 230x135x190/91x53x74 | 684 | 1507 | 1 |
| 37025-00004 | Comfort Duotech 85 CS | 274 | 24V | 2 | 850 | 900 | 4250-45746 | 75/19,81 | 80/21,13 | 140x105x130/56x41x51 | 450 | 991 | 1 |
| 37025-00010 | Comfort Duotech 85 CS RS | 274 | 24V | 2 | 850 | 900 | 4250-45746 | 75/19,81 | 80/21,13 | 140x105x130/56x41x51 | 450 | 991 | 1 |



Sprinter



MORE INFO



CHARACTERISTICS

- Suitable to work in high congested areas like small shops, offices, kitchens, schools, hospitals, bars, gyms, restaurants
- Three controls for brush drive, washing and drying operations
- Double floor squeegee for both forward and reverse drying
- Sound pressure 68 dB (A)
- Min. working height required 200 mm
- Structure built with durable materials
- Suitable load on the brush for an optimal cleaning efficiency
- Detachable detergent/recovery tank
- Cable holder
- 7mt electric cable
- Non-marking wheels.

TECHNICAL DATA

| | Sprinter |
|---------------------------|-------------------------------|
| code | 37021-00002 |
| power supply | 230 V - 50 Hz |
| scrubbing/squeegee width | 290/320 mm |
| max working capacity | 1015 m ² /h |
| solution tank capacity | 2.8 l/0.74 gal |
| recovery tank capacity | 5.6 l/1.48 gal |
| traction | mechanical |
| RPM/pressure on the brush | 1000/7 kg/15,43 lbs |
| brush motor power | 200 W |
| noise level dB (A) | 68 |
| depression/vacuum motor | 1428 mmH ₂ O/800 W |
| dimension (cm)/weight | 37 x 37 x 113/13 kg |

PLUS

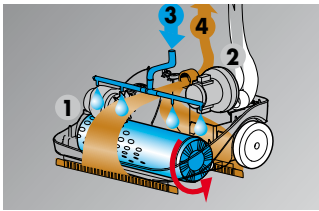

- 1) Brush motor
- 2) Vacuum motor
- 3) Detergent solution flow
- 4) Dirty liquid flow



Double squeegee for both forward and reverse washing and drying. PP brush suitable for most common floors (brush for carpet and moquette cleaning available cod. 10001-09817). ABS shock-proof covers. Non-marking rubber wheels.

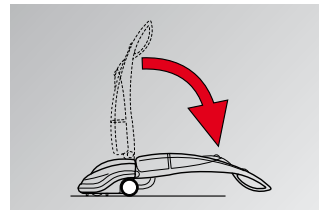

Minimum working height 200 mm, allowing perfect cleaning under furnitures, chairs, tables, beds, etc. The tilting handle makes easy and stressless the daily use of the machine. Large tank capacity avoiding frequent refilling of the unit





Cylindrical brush quick connection and release: the fitting and releasing of the brush does not require the use of tools. Ordinary cleaning and maintenance are simple and quick for anybody

STANDARD EQUIPMENT

| | | | | |
|---|--|--|---|--|
|  <ul style="list-style-type: none"> • 10001-09810 PP brush Ø 100 mm |  <ul style="list-style-type: none"> • 10001-09809 Squeegee kit |  <ul style="list-style-type: none"> • 00054-01445 Stationary plate |  <ul style="list-style-type: none"> • 00073-00036 4 x 100 ml concentrated detergent | |
|---|--|--|---|--|

OPTIONAL

| | | | | |
|---|---|--|--|--|
|  <ul style="list-style-type: none"> • 10001-09817 Carpet cleaning kit |  <ul style="list-style-type: none"> • 00058-02618 Extension electric cord 15 m with Schuko plug | | | |
|---|---|--|--|--|

Crystal clean

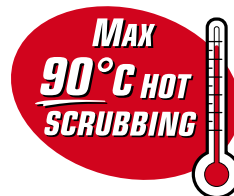

MORE INFO



CHARACTERISTICS

- Suitable to work in high congested areas like small shops, offices, kitchens, schools, hospitals, bars, gyms, restaurants
- Max 90°C hot scrubbing
- Three controls for brush drive, washing and drying operations
- Double floor squeegee for both forward and reverse drying
- Sound pressure 68 dB (A)
- Min. working height required 200 mm
- Structure built with durable materials
- Suitable load on the brush for an optimal cleaning efficiency
- Detachable detergent/recovery tank
- Cable holder
- 10 mt electric cable
- Non-marking wheels.

TECHNICAL DATA

| | Crystal Clean |
|---------------------------|-------------------------------|
| code | 37021-00004 |
| power supply | 230 V - 50 Hz |
| scrubbing/squeegee width | 290/320 mm |
| max working capacity | 1015 m ² /h |
| solution tank capacity | 2.8 l/0.74 gal |
| recovery tank capacity | 5.6 l/1.48 gal |
| traction | mechanical |
| RPM/pressure on the brush | 1000/7 kg/15,43 lbs |
| brush motor power | 200 W |
| noise level dB (A) | 68 |
| depression/vacuum motor | 1428 mmH ₂ O/800 W |
| dimension (cm)/weight | 37 x 37 x 113/14 kg |

PLUS

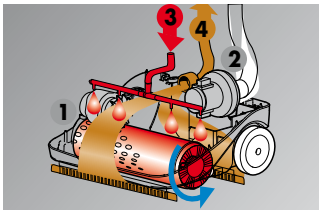

- 1) Brush motor
- 2) Vacuum motor
- 3) Hot water with detergent solution flow
- 4) Dirty liquid flow



Double squeegee for both forward and reverse washing and drying. PP brush suitable for most common floors and soft brush for carpet and moquette cleaning.

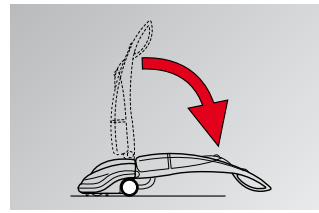

Minimum working height 200 mm, allowing perfect cleaning under furniture, chairs, tables, beds, etc. The tilting handle makes easy and stressless the daily use of the machine. Large tank capacity avoiding frequent refilling of the unit





Hot water cleaning for a faster and perfect removal of the most common organic dirt (grease, mud, oil, etc.)

STANDARD EQUIPMENT

| | | | | |
|---|---|--|---|---|
|  <ul style="list-style-type: none"> • 10001-09810 PP brush Ø 100 mm |  <ul style="list-style-type: none"> • 10002-06673 Soft brush Ø 100 mm |  <ul style="list-style-type: none"> • 10001-09809 Squeegee kit |  <ul style="list-style-type: none"> • 00054-01445 Stationary plate |  <ul style="list-style-type: none"> • 00073-00036 4 x 100 ml concentrated detergent |
|---|---|--|---|---|

OPTIONAL

| | | | | |
|---|---|--|--|--|
|  <ul style="list-style-type: none"> • 10001-09817 Carpet cleaning kit |  <ul style="list-style-type: none"> • 00058-02618 Extension electric cord 15 m with Schuko plug | | | |
|---|---|--|--|--|

Fit

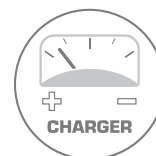
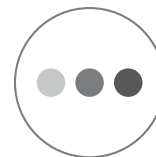

MORE INFO



CHARACTERISTICS

- Compact design for easy operation • Cordless design with Lithium-ion battery • Height adjustment handle • Foldable design for easy storage • High speed rolling brush • Detachable water tanks • LED lights at front and switches • Easy maintenance for scrubbers and brush
- Suitable for many commercial and household occasions

TECHNICAL DATA

| | Fit 35 B Li |
|--------------------------|--|
| code | 37024-00001 |
| power supply | Lithium-ion battery type 25,2V/6400mAh |
| scrubbing/squeegee width | 350/422 mm |
| max working capacity | 1500 m ² /h |
| solution tank capacity | 1,9 l/0.50 gal |
| recovery tank capacity | 1,50 l/0.39 gal |
| traction | Mechanical |
| RPM | 350 |
| brush motor power | 32 W |
| noise level dB (A) | <70 |
| suction/vacuum motor | 500 mmH ₂ O/ 70 W |
| dimension (cm)/weight | 44,7x42,2x115,9/11,3 Kg |

PLUS



Mini floor-scrubber dryer for daily cleaning, designed for the Ho.re. ca sector and cleaning companies. Washes and dries quickly saving time and effort. Lithium-ion technology: always ready to use, fast charge, maximum power.



Agile, compact and versatile: easy cleaning in the tightest areas, suitable for the cleaning of all types of "hard" floors. Ergonomic handle. Height-adjustable handle. Professional brushes to clean the most stubborn dirt.



Joint that allows to maneuver the mini floor scrubber dryer with extreme simplicity. LED headlamp. Removable detergent solution tank. Removable dirt water tank easy to empty.



Practical on/off foot switch. Drying: the squeegee ensures the floor instant drying.

STANDARD EQUIPMENT

| | | | | |
|--|---|---|---|--|
|  <ul style="list-style-type: none"> • 00080-04154 PP Brush |  <ul style="list-style-type: none"> • 00005-02201 Front squeegee blade • 00005-02202 Rear squeegee blade |  <ul style="list-style-type: none"> • 00056-00081 Battery charger UE plug |  <ul style="list-style-type: none"> • 00055-00082 Li-ION battery | |
|--|---|---|---|--|

OPTIONAL

| | | | | |
|---|--|--|--|--|
|  <ul style="list-style-type: none"> • 00056-00082 - UK plug market battery charger • 00056-00083 - USA plug market battery charger | | | | |
|---|--|--|--|--|

Ready



**LI-ION
BATTERY**

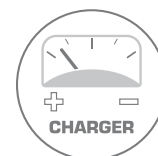
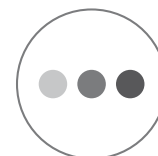

MORE INFO



CHARACTERISTICS

- Ready: washes, sweeps and dries in both working directions.
- High cleaning performance thanks to the dual contra-rotating cylindrical brushes.
- Key features: sweeping action, bi-directional drying, multi-surface capabilities (including carpets and rugs).
- "Start-stop" safety handle.
- Lightweight (only 15Kg) and easy to handle, cleaning the floor has never been less tiring.
- Maintenance and lubrication free
- Low running noise <70 dB

TECHNICAL DATA

| | Ready 32B Li |
|---------------------------|------------------------------------|
| code | 47001-00001 |
| power supply | 36V (battery and charger included) |
| scrubbing/squeegee width | 320/340 mm |
| max working capacity | 1500 m ² /h |
| solution tank capacity | 3,5 l/0.92 gal |
| recovery tank capacity | 6,0 l/1.59 gal |
| traction | mechanical |
| RPM/pressure on the brush | 650/17 kg/37.50 lbs |
| brush motor power | 200 W |
| noise level dB (A) | <70 |
| depression/vacuum motor | 1000 mmH ₂ O/100 W |
| dimension(cm)/weight | 49x41x112/15 Kg |

PLUS



Dual contra-rotating cylindrical brushes offer up to 40% more cleaning performance in a single pass, significantly increasing productivity. The machine features a safety handle for switching it on and off instantaneously.



Sweeping function thanks to the dual contra-rotating cylindrical brushes, combined with a special "mechanical" recovery system, Ready washes, sweeps and dries at the same time.



it is suited for wood, cotto, ceramic floor tiles, stone, marble, textured flooring, bolted rubber flooring, carpet tiles and carpets with ease.





The perfect balance: the centrally mounted motor and tank ensure a perfect balance, the essential prerequisite for light weight and good handling in all conditions. Completely protected components: the only fully sealed machine: no water, dust or residue of any kind can get into it.

STANDARD EQUIPMENT

| | | | | |
|--|--|--|---|---|
|  <ul style="list-style-type: none"> • 2 x 00080-04085 <p>Grey Brush (universal, all-purpose for all types of flooring)</p> |  <ul style="list-style-type: none"> • 10001-07783 <p>Kit squeegee dual - assembled</p> |  <ul style="list-style-type: none"> • 10001-07784 <p>Kit squeegee mono – not assembled</p> |  <ul style="list-style-type: none"> • 00055-00100 LH-ION battery |  <ul style="list-style-type: none"> • 00056-00010 <p>Battery Charger (V 110/115/240 50/60 Hz)</p> |
|--|--|--|---|---|

OPTIONAL

| | | | | |
|--|--|--|--|--|
|  <ul style="list-style-type: none"> • 2 x 00080-04086 <p>Black Brush (hard, all-purpose for hard floor, moquettes)</p> |  <ul style="list-style-type: none"> • 00056-00011 Fast charger | | | |
|--|--|--|--|--|

Quick



1

Model:
Quick 36B

STOP

Model:
Quick 36B Li

Model:
Quick 36B

MORE INFO



CHARACTERISTICS

- Suitable to work in high congested areas like small shops, offices, kitchens, schools, hospitals, bars, gyms, restaurants
- Adjustable flow (automatic start-stop with solenoid valve) of the detergent solution depending on type of surface
- Brush with quick release
- Removable recovery tank
- **Li-ion battery 12V** (36B Li)
- Available in battery version (36B) with integrated battery charger with data memory and for any type of batteries
- Battery included (36 B)
- Squeegee lifting lever
- Compact reclining handle with control switches
- Easy access and simple service of the components.

TECHNICAL DATA

| | Quick 36E | Quick 36B | Quick 36B Li |
|---------------------------|------------------------------|---------------------------------------|--|
| code | 37004-00004 | 37004-00003 | 37004-00077 |
| power supply | 220/240 V - 50/60 Hz | 12 V (batteries and charger included) | 12 V (Li-ion battery and charger included) |
| scrubbing/squeegee width | 360/460 mm | 360/460 mm | 360/460 mm |
| max working capacity | 1260 m ² /h | 1260 m ² /h | 1260 m ² /h |
| solution tank capacity | 11 l/2.91 gal | 11 l/2.91 gal | 11 l/2.91 gal |
| recovery tank capacity | 12-13 l/3.2 gal | 12-13 l/3.2 gal | 12-13 l/3.2 gal |
| traction | mechanical | mechanical | mechanical |
| RPM/pressure on the brush | 130/25 kg/55 lbs | 145/22 kg/48,5 lbs | 130/18 kg/39,6 lbs |
| brush motor power | 370 W | 250 W | 250 W |
| detergent solution system | solenoid valve | solenoid valve | solenoid valve |
| depression/vacuum motor | 850 mmH ₂ O/400 W | 650 mmH ₂ O/180 W | 650 mmH ₂ O/180 W |
| dimension (cm)/weight | 120x43x97/49kg | 120x43x97/57kg | 120x43x97/42,5kg |

PLUS



Reclining handle: fit on any operator's height and allowing the perfect cleaning also on 90° corners. Shock-absorbing covers, simple cleaning of the recovery tank, non marking wheels.



Easy access to mechanical parts (easy maintenance of each component), removable recovery tank without tools.









User friendly analogic control panel. Control lever for brush operation and detergent water outflow. General ON/OFF switch, brush and vacuum motor switch, solenoid valve operation switch.









Parabolic squeegee, easy rubber blades replacement. The floating brush plate and squeegee grant the right cleaning pressure on any type of floor.

STANDARD EQUIPMENT

| | | | | |
|---|---|--|---|--|
|  <ul style="list-style-type: none"> • 10002-08103 PP brush Ø 360 mm - 14" |  <ul style="list-style-type: none"> • 00005-02259 Front squeegee blade L.537 mm - Th. 1,5 mm • 00005-02260 Rear squeegee blade L.590 mm - Th. 3,0 mm |  <ul style="list-style-type: none"> • 1x 00055-00147 Maintenance free battery 12V MFP 50 65Ah C20/50Ah C-5 only for model code: 37004-00003 |  <ul style="list-style-type: none"> • 00056-00054 On-board Battery charger 12V 8A only for model code: 37004-00003 |  <ul style="list-style-type: none"> • 00058-00723 Power cable 1,5 mt. for battery charger only for model code: 37004-00003 |
|  <ul style="list-style-type: none"> • 1 x 00055-00145 Li-ion battery 12V 50Ah 705 Wh only for model code: 37004-00077 |  <ul style="list-style-type: none"> • 00056-00073 On-board Battery charger UY360 12V 20A 110-230V / 50/60Hz + 00058-02642 connection cable only for model code: 37004-00077 | | | |

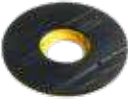
OPTIONAL

| | | | | |
|--|---|---|---|--|
|  <ul style="list-style-type: none"> • 00055-00146 Battery AGM 12V 55Ah only for model code: 37004-00003 |  <ul style="list-style-type: none"> • 00056-00046 Booster battery charger |  <ul style="list-style-type: none"> • 00005-02257 Polyurethane front blade L.537 TH. 2 • 00005-02258 Polyurethane rear blade L.590 TH. 2,5 |  <ul style="list-style-type: none"> • 10002-08104 Tynex brush Ø 360 mm-14" • 10002-08105 PP 0,3 brush Ø 360 mm-14" • 10002-08106 PES brush Ø 360 mm-14" |  <ul style="list-style-type: none"> • 10002-08107 EWU pad driver Ø 360mm-14" |
|  <ul style="list-style-type: none"> • 10001-09944 Abrasive pad Ø 381 mm-15" - beige (5 pcs.) • 10001-09945 Abrasive pad Ø 381 mm-15" - green (5 pcs.) • 10001-09942 Abrasive pad Ø 381 mm-15" - black (5 pcs.) |  <ul style="list-style-type: none"> • 00058-02618 Extension electric cord 15 m with Schuko plug (optional on model 37004-00004) | | | |

Dart



Model:
Dart 38B

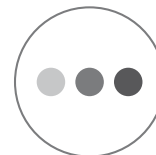

Model:
Dart 38B Li

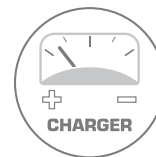

Model:
Dart 38B



MORE INFO



CHARACTERISTICS

• Ideal for small and medium floors up to 1260 sqm, especially when congested by people or furnishing like in wellness centres, gyms, car showroom, retail shops, hospitals and schools. • **Li-ion battery 24V** (38B Li) • Automatic brush attachment, discharge and delayed cut-off. • Narrow body with both side brush protrusion and 300° squeegee spin. • Toolless removable recovery tank with large visual inspection window and stretchable discharge hose. • Adjustable driving handle with dead man switches, soft touch controls and diagnosis (Eco Energy mode and battery low level automatic cut-off for DC version). • Clean water tank level indicator • Large non marking working wheels and sturdy rear roller for displacements.

TECHNICAL DATA

| | Dart 36E | Dart 36B | Dart 36B | Dart 38B Li |
|---------------------------|------------------------------|--------------------------------|--------------------------------------|---|
| code | 37012-00031 | 37012-00032 | 37012-00033 | 37012-00049 |
| power supply | 220/240 V 50/60Hz | 24V (battery charger included) | 24V (batteries and charger included) | 24V (Li-ion battery and charger included) |
| scrubbing/squeegee width | 360/460 mm | 360/460 mm | 360/460 mm | 380/460 mm |
| max working capacity | 1260 m ² /h | 1260 m ² /h | 1260 m ² /h | 1350 m ² /h |
| solution tank capacity | 15 l/3.96 gal | 15 l/3.96 gal | 15 l/3.96 gal | 15 l/3.96 gal |
| recovery tank capacity | 16 l/4.23 gal | 16 l/4.23 gal | 16 l/4.23 gal | 16 l/4.23 gal |
| traction | mechanical | mechanical | mechanical | mechanical |
| RPM/pressure on the brush | 130/18 kg/40 lbs | 160/27 kg/60 lbs | 160/27 kg/60 lbs | 160/27 kg/60 lbs |
| brush motor power | 300 W | 400 W | 400 W | 400 W |
| detergent solution system | solenoid valve | solenoid valve | solenoid valve | solenoid valve |
| depression/vacuum motor | 850 mmH ₂ O/350 W | 850 mmH ₂ O/270 W | 850 mmH ₂ O/270 W | 850 mmH ₂ O/270 W |
| dimension (cm)/weight | 98x47x99/57 kg | 98x47x99/46 kg | 98x47x99/70 kg | 98x47x99/63 kg |

PLUS



On/off switch protecting unintentional use. Protection against overloads, battery discharge abuse (DC only) and undesired run. Convenient one switch maintenance over the brush. Eco Energy setting for extensive working time and extremely quite operations (DC only).



Extensive squeegee spin for easy blade replacement and perfect suction even on corners. Easy setting and automatic solution release to save chemical and fit different floor conditions. High stability and capability to overtake small steps.









Easy access and handling to clean recovery tank and floater. Less downtimes due to simple maintenance and construction. Great visibility and cleaning capability on hard to reach edges on both sides of the brush.









They provide more power, longer life and much faster charging times. They are not affected by the memory effect and are lighter in weight with lower maintenance costs.

STANDARD EQUIPMENT

| | | | | |
|--|--|---|---|--|
|  <ul style="list-style-type: none"> • 10002-08145 PP brush Ø 380 mm - 15" (38 B Li) • 10002-13271 PP brush Ø 360 mm - 14" (36 B- 36 E) |  <ul style="list-style-type: none"> • 00005-02259 Front squeegee blade L.537 mm - Th. 1,5 mm • 00005-02296 Rear squeegee blade L.590 mm - Th. 3,0 mm |  <ul style="list-style-type: none"> • 00056-00064 On-board Battery charger 24V-5A only for model code: 37012-00032 37012-00033 |  <ul style="list-style-type: none"> • 2x 00055-00098 AGM NP3312 12 V 33 Ah C20/28 Ah C5 (only for model code: 37012-00033) | |
|  <ul style="list-style-type: none"> • 00056-00076 On-board Battery charger 29,4V 12A 110-230V 50/60Hz only for model code: 37012-00049 |  <ul style="list-style-type: none"> • 1 x 00055-00144 Li-ion battery 12V 50Ah 705 Wh only for model code: 37012-00049 | | | |

OPTIONAL

| | | | | |
|--|---|---|---|--|
|  <ul style="list-style-type: none"> • 2x 00055-00098 AGM NP3312 12 V 33 Ah C20/28 Ah C5 |  <ul style="list-style-type: none"> • 00005-02257 Polyurethane front blade L.537 TH. 2 • 00005-02258 Polyurethane rear blade L.590 TH. 2,5 |  <ul style="list-style-type: none"> • 10002-08104 Tynex brush Ø 360 mm-14" • 10002-08105 PP 0,3 brush Ø 360 mm-14" • 10002-08106 PES brush Ø 360 mm-14" |  <ul style="list-style-type: none"> • 10002-08146 Tynex brush Ø 380 mm-15" • 10002-08147 PP 0,3 brush Ø 380 mm-15" • 10002-08148 PES brush Ø 380 mm - 15" |  <ul style="list-style-type: none"> • 10002-08107 EWU pad driver Ø 360mm-14" |
|  <ul style="list-style-type: none"> • 10001-09944 Abrasive pad Ø 381 mm-15" - beige (5 pcs.) • 10001-09945 Abrasive pad Ø 381 mm-15" - green (5 pcs.) • 10001-09942 Abrasive pad Ø 381 mm-15" - black (5 pcs.) |  <ul style="list-style-type: none"> • 00058-02618 Extension electric cord 15 m with Schuko plug (optional on model 37012-00031) | | | |

Dynamic



Model:
Dynamic 45B

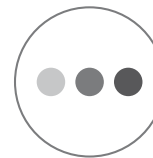

Model:
Dynamic 45B Li

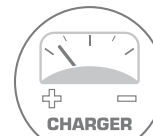

Model:
Dynamic 45B



MORE INFO



CHARACTERISTICS

• Ideal for small and medium floors up to 1600sqm, especially when congested by people or furnishing like in wellness centres, gyms, car showroom, retail shops, hospitals and schools. • **Li-ion battery 24V** (45B Li) • Automatic brush attachment, discharge and delayed cut-off. • Adjustable solution release with automatic cut-off. • Narrow body with both side brush protrusion and 300° squeegee spin. • Toolless removable recovery tank with large visual inspection window and stretchable discharge hose. • Adjustable driving handle with dead man switches, soft touch controls and diagnosis (Eco Energy mode and battery low level automatic cut-off for DC version). • Large non marking working wheels and sturdy rear roller for displacements.

TECHNICAL DATA

| | Dynamic 45E | Dynamic 45B | Dynamic 45B | Dynamic 45B Li |
|---------------------------|-------------------------------|--------------------------------|--------------------------------------|------------------------------------|
| code | 37011-00051 | 37011-00052 | 37011-00053 | 37011-00079 |
| power supply | 230V-50Hz | 24V (battery charger included) | 24V (batteries and charger included) | 24V (battery and charger included) |
| scrubbing/squeegee width | 450/540 mm | 450/540 mm | 450/540 mm | 450/540 mm |
| max working capacity | 1600 m ² /h | 1600 m ² /h | 1600 m ² /h | 1600 m ² /h |
| solution tank capacity | 30 l/7.92 gal | 30 l/7.92 gal | 30 l/7.92 gal | 30 l/7.92 gal |
| recovery tank capacity | 32-35 l/8.45 - 9.24 gal | 32-35 l/8.45 - 9.24 gal | 32-35 l/8.45 - 9.24 gal | 32-35 l/8.45 - 9.24 gal |
| traction | mechanical | mechanical | mechanical | mechanical |
| RPM/pressure on the brush | 145/32 kg/70,5 lbs | 145/32 kg/70,5 lbs | 145/32 kg/70,5 lbs | 150/31 kg/68 lbs |
| brush motor power | 300 W | 400 W | 400 W | 400 W |
| detergent solution system | solenoid valve | solenoid valve | solenoid valve | solenoid valve |
| depression/vacuum motor | 1200 mmH ₂ O/700 W | 1200 mmH ₂ O/400 W | 1200 mmH ₂ O/400 W | 1200 mmH ₂ O/400 W |
| dimension (cm)/weight | 117x58x99/66 kg | 117x58x99/53 kg | 117x58x99/94 kg | 117x58x99/77,5 kg |

PLUS



On/off switch protecting unintentional use. Protection against overloads, battery discharge abuse (DC only) and undesired run. Convenient one switch maintenance over the brush. Eco Energy setting for extensive working time and extremely quite operations (DC only).



Accessible on-board charger (DC only, when provided), far away from sprays. Time saving convenient foot operating squeegee lift. Handle can be easily adjusted to fit comfort of operators even in narrow spaces.



Easy access and handling to clean recovery tank and floater. Less downtimes due to simple maintenance and construction. Great visibility and cleaning capability on hard to reach edges on both sides of the brush.









They provide more power, longer life and much faster charging times. They are not affected by the memory effect and are lighter in weight with lower maintenance costs.

STANDARD EQUIPMENT

| | | | | |
|--|--|--|---|--|
|  <ul style="list-style-type: none"> • 10002-08117 PP brush Ø 430 mm - 17" |  <ul style="list-style-type: none"> • 00005-02276 Front squeegee blade Shore 40 Th. 2,5 mm • 00005-02277 Rear squeegee blade Shore 40 Th. 3,0 mm |  <ul style="list-style-type: none"> • 00056-00062 On-board Battery charger 24V 10A (only for model code: 37011-00052/37011-00053) |  <ul style="list-style-type: none"> • 2 x 00055-00147 Maintenance free battery 12V MFP 50 65Ah C20/50Ah C-5 only for model code: 37011-00053 | |
|  <ul style="list-style-type: none"> • 00056-00076 On-board Battery charger 29,4V 12A 110-230V 50/60Hz only for model code: 37011-00079 |  <ul style="list-style-type: none"> • 1x 00055-00144 Li-ion battery 24V 30 Ah 700Wh only for model code: 37011-00079 | | | |

OPTIONAL

| | | | | |
|---|---|---|---|--|
|  <ul style="list-style-type: none"> • 2 x 00055-00146 Battery AGM 12V 55Ah only for model code: 37011-00053 |  <ul style="list-style-type: none"> • 00005-02278 Polyurethane front blade L.665 • 00005-02279 Polyurethane rear blade L.775 |  <ul style="list-style-type: none"> • 10002-08118 Tynex brush Ø 430 mm-17" • 10002-08119 PP 0,3 brush Ø 430 mm-17" • 10002-08120 PES brush Ø 430 mm - 17" |  <ul style="list-style-type: none"> • 10002-13151 EWU pad driver Ø 430 mm-17" |  <ul style="list-style-type: none"> • 10001-09913 Abrasive pad Ø 430 mm-17" - beige (5 pcs.) • 10001-09918 Abrasive pad Ø 430 mm-17" - green (5 pcs.) • 10001-09923 Abrasive pad Ø 430 mm-17" - black (5 pcs.) |
|  <ul style="list-style-type: none"> • 00058-02618 Extension electric cord 15 m with Schuko plug (optional on model 37011-00051) | <ul style="list-style-type: none"> • 00055-00088 Li-ion battery 55 Ah | <ul style="list-style-type: none"> • 00056-00093 Battery charger CBH2D 24V 20A | | |

Free Evo



Model:
Free 50B

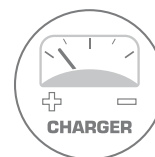
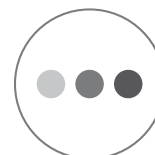

Model:
Free 50B

MORE INFO



CHARACTERISTICS

- Very compact scrubbing machines suitable to work for the maintenance cleaning of limited-size areas (up to 1.500 m²)
- Especially suitable for cleaning: car shops, sales points, gym, health care
- Control panel with operator presence safety system
- Low level battery indicator: brush/vacuum and traction progressive cut off (Battery models)
- Solution water filter and solenoid valve
- Easy access to the battery compartment
- Quick drain and easily inspectable recovery tank
- Non-marking wheels
- Roto-molded polyethylene tanks, shock and acid resistant
- The lower tank also serves as battery compartment
- Low noise operation thanks to the protected positioning of vacuum motor.

Other available versions:

- 37031-00013 - Free Evo 50B with batteries and battery charger
- 37031-00016 - Free Evo 50BT with batteries and battery charger

TECHNICAL DATA

| | Free Evo 50E | Free Evo 50B | Free Evo 50B | Free Evo 50BT | Free Evo 50BT |
|---------------------------|------------------------------|------------------------------|--------------------------------|------------------------------|--------------------------------|
| code | 37031-00003 | 37031-00104 | 37031-00001 | 37031-00105 | 37031-00002 |
| power supply | 230 V - 50 Hz | 24V | 24V (battery charger included) | 24V | 24V (battery charger included) |
| scrubbing/squeegee width | 500/800 mm | 500/800 mm | 500/800 mm | 500/800 mm | 500/800 mm |
| max working capacity | 2000 m ² /h | 2000 m ² /h | 2000 m ² /h | 2000 m ² /h | 2000 m ² /h |
| solution tank capacity | 44 l/11,63 gal | 44 l/11,63 gal | 44 l/11,63 gal | 44 l/11,63 gal | 44 l/11,63 gal |
| recovery tank capacity | 50-60 l/13,21-16 gal | 50-60 l/13,21-16 gal | 50-60 l/13,21-16 gal | 50-60 l/13,21-16 gal | 50-60 l/13,21-16 gal |
| traction/traction motor | mechanical | mechanical | mechanical | automatic/150W | automatic/150W |
| RPM/pressure on the brush | 145/20 kg/44 lbs | 145/20 kg/44 lbs | 145/20 kg/44 lbs | 145/20 kg/44 lbs | 145/20 kg/44 lbs |
| brush motor power | 550W | 550W | 550W | 550W | 550W |
| detergent solution system | solenoid valve | solenoid valve | solenoid valve | solenoid valve | solenoid valve |
| depression/vacuum motor | 1700 mmH ₂ O/800W | 1280 mmH ₂ O/400W | 1280 mmH ₂ O/400W | 1280 mmH ₂ O/400W | 1280 mmH ₂ O/400W |
| dimension (cm)/weight | 116x46x98/95 kg | 116x51x98/62 kg | 116x51x98/63 kg | 116x51x98/66 kg | 116x51x98/67 kg |

PLUS



Powerful gearmotor; metal brush plate with integrated plastic splash guard/bumper.



The outflow of the detergent solution is controlled by a solenoid valve. The actuation of the solenoid valve is operated by the control lever, avoiding the detergent solution outflow when the brush is stopped during the interruptions of work.



Renovated squeegee with new pressure adjusting system. Quick and easy squeegee coupling through the two large knobs; the squeegee is released without any damage in the event of accidental impact.





Easy and intuitive controls. The outflow of the cleaning solution is easily controlled using the mechanical lever placed on the control panel. Inspectable mesh filter to trap any existing solid body in the cleaning solution.









Upgrade battery model to *Li-ion battery model*

- 1x 00055-00088 Li-ion battery 55 Ah
- 1x 00056-00093 Battery charger CBH2D 24V 20A
- 2x 00078-00231 Strip dual lock
- 1x 00058-03383 electric extension cable for battery to battery charger connection 8 m
- 1x 10002-09736 ballast

STANDARD EQUIPMENT

| | | | | |
|---|---|---|--|--|
|  <ul style="list-style-type: none"> • 10002-08127 PP brush Ø 483 mm - 19" |  <ul style="list-style-type: none"> • 00005-02298 Front squeegee blade L.830 mm Shore 40 Th. 2.5 mm • 00005-02297 Rear squeegee blade L.870 mm Shore 40 Th. 3 mm |  <ul style="list-style-type: none"> • 00056-00038 On-board Battery charger 24V 10A only for model code: 37031-00001/37031-00002 37031-00013/37031-00016 |  <ul style="list-style-type: none"> • 2 x 00055-00151 Maintenance free battery 12V 75Ah BT DC 5.5 only for model code: 37031-00013/37031-00016 | |
|---|---|---|--|--|

OPTIONAL

| | | | | |
|--|---|---|---|---|
|  <ul style="list-style-type: none"> • 2 x 00055-00149 Tubular battery Pb-acid 12V 118Ah C5 |  <ul style="list-style-type: none"> • 2 x 00055-00130 GEL Battery 12 MFP 105 12V 105Ah C5 |  <ul style="list-style-type: none"> • 00005-02268 Polyurethane front blade L.830 TH. 3 • 00005-02267 Polyurethane rear blade L.870 TH. 4 |  <ul style="list-style-type: none"> • 10002-08128 Tynex brush Ø 483 mm-19" • 10002-08129 PP 0,3 brush Ø 483 mm-19" • 10002-08130 PES brush Ø 483 mm - 19" |  <ul style="list-style-type: none"> • 10002-08131 EWU pad driver Ø 483 mm-19" |
|  <ul style="list-style-type: none"> • 10001-09914 Abrasive pad Ø 483 mm-19" - beige (5 pcs.) • 10001-09919 Abrasive pad Ø 483 mm-19" - green (5 pcs.) • 10001-09924 Abrasive pad Ø 483 mm-19" - black (5 pcs.) |  <ul style="list-style-type: none"> • 00058-02618 Extension electric cord 15 m with Schuko plug (optional on model 37031-00003) | | | |

Moving 55E/55B

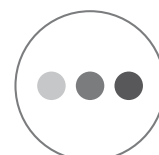
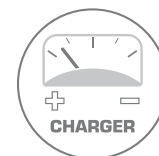

MORE INFO



CHARACTERISTICS

- Very compact floor scrubber dryer suitable to work for the maintenance cleaning of limited-size areas
- Ideal for cleaning car shops, sales points, gym, health care
- Control panel with operator presence safety system
- Low level battery indicator with brush/vacuum and traction progressive cut off (Battery models)
- Solution water filter and solenoid valve
- Easy access to the battery compartment
- Quick drain and easily inspectable recovery tank
- Non-marking wheels
- Roto-molded polyethylene tanks, shock and acid resistant
- Shock and acid resistant
- The lower tank is also battery compartment
- Low noise operation thanks to the protected positioning of vacuum motor.
- Possibility to mount Li-ion batteries
- Accessory storage facility on request
- Chemical dispenser tank (optional)
- New fulcrum and new lever for squeegee adjustment
- New detergent solution adjustment level
- New control panel with electrical board with Fleet Management System (available on request)
- Solution tank easy to refill thanks to the special hose supplied as standard which can be connected directly to the water supply

TECHNICAL DATA

| | Moving 55E | Moving 55B | Moving 55B | Moving 55B |
|---------------------------|------------------------------|------------------------------|---------------------------------|-------------------------------------|
| code | 37033-00002 | 37033-00003 | 37033-00004 | 37033-00005 |
| power supply | 230 V - 50 Hz | 24 V | 24 V (battery charger included) | 24 V (battery and charger included) |
| scrubbing/squeegee width | 550/800 mm | 550/800 mm | 550/800 mm | 550/800 mm |
| max working capacity | 2200 m ² /h | 2200 m ² /h | 2200 m ² /h | 2200 m ² /h |
| solution tank capacity | 55 l/14,5 gal | 55 l/14,5 gal | 55 l/14,5 gal | 55 l/14,5 gal |
| recovery tank capacity | 60 l/16 gal | 60 l/16 gal | 60 l/16 gal | 60 l/16 gal |
| traction/traction motor | mechanical | mechanical | mechanical | mechanical |
| RPM/pressure on the brush | 165/22 kg/48 lbs | 150/22 kg/48 lbs | 150/22 kg/48 lbs | 150/22 kg/48 lbs |
| brush motor power | 550W | 550W | 550W | 550W |
| detergent solution system | solenoid valve | solenoid valve | solenoid valve | solenoid valve |
| depression/vacuum motor | 1700 mmH ₂ O/800W | 1280 mmH ₂ O/400W | 1280 mmH ₂ O/400W | 1280 mmH ₂ O/400W |
| dimension (cm)/weight | 127x65x102/74 kg | 127x65x102/74 kg | 127x65x102/75 kg | 127x65x102/130 kg |

PLUS



Large and easily inspectable roto-molded polyethylene tank, shock and acid resistant



Solution tank level indicator



Electromechanical sensor for dirty water level signaling

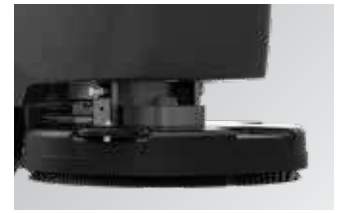





Sturdy aluminium brush plate with brush coupling and release









Upgrade battery model to *Li-ion battery model*

- 1x 00055-00088 Li-ion battery 55 Ah
- 1x 00056-00093 Battery charger CBH2D 24V 20A
- 2x 00078-00231 Strip dual lock
- 1x 00058-03383 electric extension cable for battery to battery charger connection 8 m
- 1x 10002-09736 ballast

STANDARD EQUIPMENT

| | | | | |
|---|---|--|--|---|
|  <ul style="list-style-type: none"> • 10002-14574 PP brush Ø 533 mm - 21" |  <ul style="list-style-type: none"> • 00005-02282 Rear squeegee blade L.900 mm Shore 40 Th. 3 mm • 00005-02283 Front squeegee blade L.860 mm Shore 33 Th. 2 mm |  <ul style="list-style-type: none"> • 00056-00062 On-board Battery charger 24V 10A only for model code: 37033-00004/37033-00005) |  <ul style="list-style-type: none"> • 2 x 00055-00151 Maintenance free battery 12V 75Ah BT DC 5.5 only for model code: 37033-00005 |  <ul style="list-style-type: none"> • Refill hose |
|---|---|--|--|---|

OPTIONAL

| | | | | |
|--|---|---|---|---|
|  <ul style="list-style-type: none"> • 2 x 00055-00149 Tubular battery Pb-acid 12V 118Ah C5 |  <ul style="list-style-type: none"> • 2 x 00055-00130 GEL Battery 12 MFP 105 12V 105Ah C5 |  <ul style="list-style-type: none"> • 2x 00055-00088 Battery Li-ion 25,6V 55Ah 1382Wh |  <ul style="list-style-type: none"> • 1x 00056-00093 battery charger 24V 20A |  <ul style="list-style-type: none"> • 00005-02284 Polyurethane rear blade L.900 TH. 3 • 00005-02285 Polyurethane front blade L.860 TH. 2 |
|  <ul style="list-style-type: none"> • 10002-14572 Tynex brush Ø 533 mm-21" • 10002-14571 PP 03 brush Ø 533 mm-21" • 10002-14573 PES brush Ø 533 mm-21" |  <ul style="list-style-type: none"> • 10002-14570 EWU pad driver Ø 505 mm-20" |  <ul style="list-style-type: none"> • Float filling system with acquastop on request |  <ul style="list-style-type: none"> • 10001-12852 accessory hook kit | |

Moving 55BT

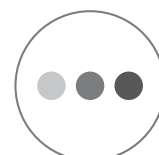
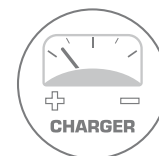

MORE INFO



CHARACTERISTICS

- Very compact floor scrubber dryer suitable to work for the maintenance cleaning of limited-size areas
- Ideal for cleaning car shops, sales points, gym, health care
- Control panel with operator presence safety system
- Low level battery indicator with brush/vacuum and traction progressive cut off
- Solution water filter and solenoid valve
- Easy access to the battery compartment
- Quick drain and easily inspectable recovery tank
- Non-marking wheels
- Roto-molded polyethylene tanks, shock and acid resistant
- Shock and acid resistant
- The lower tank is also battery compartment
- Low noise operation thanks to the protected positioning of vacuum motor.
- Separate chemist.
- Possibility to mount Li-ion batteries
- Accessory storage facility on request
- Detergent dosing kit 1,5 l only code 37033-00008
- New fulcrum and new lever for squeegee adjustment
- New detergent solution adjustment level
- New control panel with electrical board with Fleet Management System (available on request)
- Sturdy aluminium brush plate with brush coupling and release
- Solution tank easy to refill thanks to the special hose supplied as standard which can be connected directly to the water supply

TECHNICAL DATA

| | Moving 55BT | Moving 55BT | Moving 55BT | Moving 55BT |
|---------------------------|------------------------------|---------------------------------|-------------------------------------|-------------------------------------|
| code | 37033-00001 | 37033-00006 | 37033-00007 | 37033-00008 |
| power supply | 24 V | 24 V (battery charger included) | 24 V (battery and charger included) | 24 V (battery and charger included) |
| scrubbing/squeegee width | 550/800 mm | 550/800 mm | 550/800 mm | 550/800 mm |
| max working capacity | 2200 m ² /h | 2200 m ² /h | 2200 m ² /h | 2200 m ² /h |
| solution tank capacity | 55 l/14,5 gal | 55 l/14,5 gal | 55 l/14,5 gal | 55 l/14,5 gal |
| recovery tank capacity | 60 l/16 gal | 60 l/16 gal | 60 l/16 gal | 60 l/16 gal |
| traction/traction motor | automatic/180W | automatic/180W | automatic/180W | automatic/180W |
| RPM/pressure on the brush | 150/22 kg/48 lbs | 150/22 kg/48 lbs | 150/22 kg/48 lbs | 150/22 kg/48 lbs |
| brush motor power | 550W | 550W | 550W | 550W |
| detergent solution system | solenoid valve | solenoid valve | solenoid valve | solenoid valve + dosing kit |
| depression/vacuum motor | 1280 mmH ₂ O/400W | 1280 mmH ₂ O/400W | 1280 mmH ₂ O/400W | 1280 mmH ₂ O/400W |
| dimension (cm)/weight | 127x65x102/83 kg | 127x65x102/84 kg | 127x65x102/139 kg | 127x65x102/139 kg |

PLUS

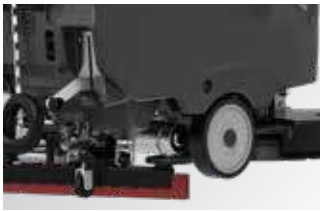

Front-wheel drive equipped with reverse



Large and easily inspectable rotomolded polyethylene tank, shock and acid resistant



Solution tank level indicator







Chemical dispenser tank (optional)
Standard on the model code 37033-00008 Moving 55BT











Upgrade battery model to *Li-ion battery model*

- 1x 00055-00088 Li-ion battery 55 Ah
- 1x 00056-00093 Battery charger CBH2D 24V 20A
- 2x 00078-00231 Strip dual lock
- 1x 00058-03383 electric extension cable for battery to battery charger connection 8 m
- 1x 10002-09736 ballast

STANDARD EQUIPMENT

| | | | | |
|---|---|--|--|---|
|  <ul style="list-style-type: none"> • 10002-14574 PP brush Ø 533 mm - 21" |  <ul style="list-style-type: none"> • 00005-02282 Rear squeegee blade L.900 mm Shore 40 Th. 3 mm • 00005-02283 Front squeegee blade L.860 mm Shore 33 Th. 2 mm |  <ul style="list-style-type: none"> • 00056-00062 On-board Battery charger 24V 10A only for model code: 37033-00006/37033-00007/37033-00008) |  <ul style="list-style-type: none"> • 2 x 00055-00151 Maintenance free battery 12V 75Ah BT DC 5.5 only for model code: 37033-00007/37033-00008 |  <ul style="list-style-type: none"> • Refill hose |
|---|---|--|--|---|

OPTIONAL

| | | | | |
|--|---|---|---|---|
|  <ul style="list-style-type: none"> • 2 x 00055-00149 Tubular battery Pb-acid 12V 118Ah C5 |  <ul style="list-style-type: none"> • 2 x 00055-00130 GEL Battery 12 MFP 105 12V 105Ah C5 |  <ul style="list-style-type: none"> • 2x 00055-00088 Battery Li-ion 25,6V 55Ah 1382Wh |  <ul style="list-style-type: none"> • 1x 00056-00093 battery charger 24V 20A |  <ul style="list-style-type: none"> • 00005-02284 Polyurethane rear blade L.900 TH. 3 • 00005-02285 Polyurethane front blade L.860 TH. 2 |
|  <ul style="list-style-type: none"> • 10002-14572 Tynex brush Ø 533 mm-21" • 10002-14571 PP 03 brush Ø 533 mm-21" • 10002-14573 PES brush Ø 533 mm-21" |  <ul style="list-style-type: none"> • 10002-14570 EWU pad driver Ø 505 mm-20" |  <ul style="list-style-type: none"> • Float filling system with acquastop on request |  <ul style="list-style-type: none"> • 10001-12852 accessory hook kit | |

Next Evo

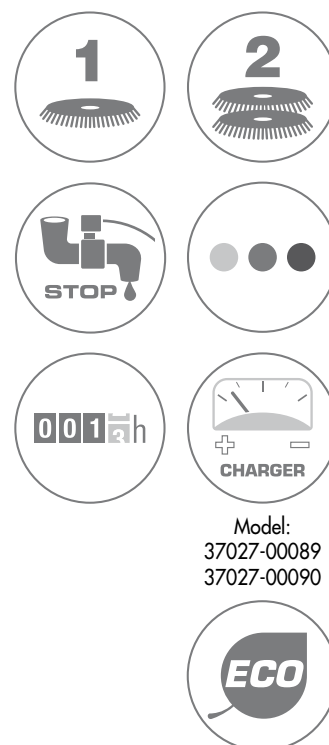

Model:
37027-00089
37027-00090

MORE INFO



CHARACTERISTICS

- Designed for the maintenance and deep cleaning of large areas (up to 1.700 m²)
- Especially suitable for cleaning: car shops, sales points, gym, health care
- User friendly control panel
- Hour meter
- Automatic brush lifting (only model 66BTA)
- Fully accessible recovery water tank with visual inspection
- Automatic detergent measuring system
- Big size traction wheels
- Handle with control lever.

TECHNICAL DATA

| | Next Evo 55BT | Next Evo 55BT | Next Evo 66BTA | Next Evo 66BTA |
|-----------------------------|-------------------------------|--------------------------------|-------------------------------|--------------------------------|
| code | 37027-00101 | 37027-00089 | 37027-00102 | 37027-00090 |
| power supply | 24V | 24V (battery charger included) | 24V | 24V (battery charger included) |
| scrubbing/squeegee width | 550/800 mm | 550/800 mm | 660/800 mm | 660/800 mm |
| max working capacity | 2200 m ² /h | 2200 m ² /h | 2640 m ² /h | 2640 m ² /h |
| solution tank capacity | 55 l/14.5 gal | 55 l/14.5 gal | 55 l/14.5 gal | 55 l/14.5 gal |
| recovery tank capacity | 55-65 l/14.52-17.17 gal | 55-65 l/14.52-17.17 gal | 55-65 l/14.52-17.17 gal | 55-65 l/14.52-17.17 gal |
| traction/traction motor | automatic/200W | automatic/200W | automatic/200W | automatic/200W |
| RPM/pressure on the brushes | 165/30 kg/66 lbs | 165/30 kg/66 lbs | 175/33 kg/72 lbs | 175/33 kg/72 lbs |
| brush motor power | 550 W | 550 W | 2 x 400 W | 2 x 400 W |
| detergent solution system | solenoid valve | solenoid valve | solenoid valve | solenoid valve |
| depression/vacuum motor | 1200 mmH ₂ O/400 W | 1200 mmH ₂ O/400 W | 1200 mmH ₂ O/400 W | 1200 mmH ₂ O/400 W |
| dimension (cm)/weight | 128x71x106/106 kg | 128x71x106/106 kg | 128x71x106/110 kg | 128x71x106/110 kg |

PLUS



User friendly analogic control panel. Control lever for brush operation and detergent water outflow. ON/OFF and battery cutout key switch, brush and vacuum motor switch, detergent regulation device.



Detergent regulation device. Recovery tank drain hose with adjustable flow system. Automatic brush lifting (only model 66BTA).



Automatic detergent dosing system (only for model code: 37027-00089/37027-00090) Fully accessible recovery water tank with visual inspection. Easy access to the recovery tank. Easy access and simple service of the components without use of tools.

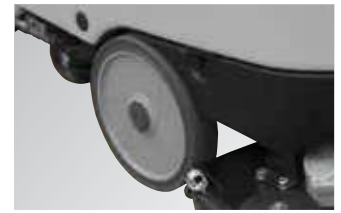

Big size wheels for better maneuverability and effortless use. Battery trolley for a quick and easy battery change (only for model code: 37027-00089/37027-00090)

STANDARD EQUIPMENT

| | | | | |
|---|---|---|---|--|
|  <p>Next Evo 55 • 10002-08132 PP brush Ø 533 mm - 21"</p> |  <p>Next Evo 66 • 2 x 10002-08102 PP brush Ø 330 mm - 13"</p> |  <p>• 00005-02283 Front squeegee blade L.860 mm Shore 33 Th. 4 mm • 00005-02282 Rear squeegee blade L.900 mm Shore 40 Th. 4 mm</p> |  <p>• 00056-00052 On-board Battery charger 24V 12A only for model code: 37027-00089/ 37027-00090</p> | |
|---|---|---|---|--|

OPTIONAL

| | | | | |
|--|--|---|---|--|
|  <p>• 2 x 00055-00149 Tubular battery Pb-acid 12V 118Ah C5</p> |  <p>• 2 x 00055-00130 GEL Battery 12 MFP 105 12V 105Ah C5</p> |  <p>• 00056-00065 Battery Charger 24V 13A 220-240/50-60</p> |  <p>• 00005-02285 Polyurethane front blade L.860 TH. 2 • 00005-02284 Polyurethane rear blade L.900 TH. 3</p> |  <p>• 10002-08133 Tynex brush Ø 533 mm-21" • 2x 10002-08098 Tynex brush Ø 330 mm-13"</p> |
|  <p>• 10002-08134 PP brush Ø 533 mm-21" • 2x 10002-08099 PP 0,3 brush Ø 330 mm-13" 2x</p> |  <p>• 10002-08135 PES brush Ø 533 mm-21" • 2x 10002-08100 PES brush Ø 330 mm-13" 2x</p> |  <p>• 10002-08136 EWU pad driver Ø 533mm-21" • 2x 10002-08101 EWU pad driver Ø 330mm-13"</p> |  <p>(5 pcs package) • 10001-09915 - Ø 533 mm-21"- beige • 10001-09920 - Ø 533 mm-21"- green • 10001-09925 - Ø 533 mm-21"- black</p> |  <p>(5 pcs package) • 10001-09911 - Ø 340 mm-13"- beige • 10001-09916 - Ø 340 mm-13"- green • 10001-09921 - Ø 340 mm-13"- black</p> |

Easy-R

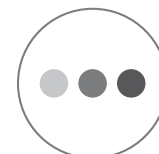

MORE INFO



CHARACTERISTICS

- Suitable to work for the maintenance and deep cleaning of large areas (up to 2.200 m²)
- User friendly control panel: forward speed setting, scrubbing and vacuuming selectors, battery charge indicator, traction direction indicator, key main switch
- Large handle with traction driving lever for forward and backward directions
- Self levelling brush plate
- Cover removable without tools provided with self locking system
- Quick vacuum motor and filter inspection, without tools
- Detergent solution tank with large opening protected by quick locking cap
- Parking brake directly on the wheel
- Non-marking wheels
- Easy squeegee regulation without tools
- Movable shock-proof squeegee
- Hour meter and solenoid valve.
- Quick refilling system

TECHNICAL DATA

| | Easy-R 55BT | Easy-R 66BT |
|-----------------------------|------------------------------|------------------------------|
| code | 37002-00093 | 37002-00101 |
| power supply | 24V | 24V |
| scrubbing/squeegee width | 550/800 mm | 660/800 mm |
| max working capacity | 2475 m ² /h | 2970 m ² /h |
| solution tank capacity | 67 l/17.70 gal | 67 l/17.70 gal |
| recovery tank capacity | 75-95 l/20.35-25 gal | 75-95 l/20.35-25 gal |
| traction/traction motor | automatic/200W | automatic/200W |
| RPM/pressure on the brushes | 150/45 kg/99.20 lbs | 150/24 kg/52.91 lbs |
| brush motor power | 600 W | 600 W |
| detergent solution system | solenoid valve | solenoid valve |
| depression/vacuum motor | 1280 mmH ₂ O/450W | 1280 mmH ₂ O/450W |
| dimension (cm)/weight | 135x56x102/100 kg | 135x56x102/93 kg |

PLUS



User friendly control panel. Speed adjustment selectors. General ON/OFF and key switch, brush and vacuum motor switch. Thermal circuit breaker to protect vacuum motor and brush motor, battery level control, hour meter.



Easy access to battery and vacuum motor compartment, without using tools. Large tank capacity, at the top in the category (67 l). 2 x 12V -118 Ah C5 batteries to grant long work autonomy, up to 3 hours.



Control lever for brush operation and detergent water outflow. Recovery tank drain hose. Quick fitting battery charger plug.



Heavy duty 15 mm steel monobloc brush plate. Great pressure on the floor for a deep cleaning even on the toughest dirt. Self levelling system. Solenoid valve to stop the detergent water outflow during the work interruptions.

STANDARD EQUIPMENT

| | | | | |
|---|---|---|--|--|
|  <p>Easy-R 55BT • 2 x 10002-08092 PP brush Ø 275 mm - 10"</p> |  <p>Easy-R 66BT • 2 x 10002-08097 PP brush Ø 330 mm - 13"</p> |  <ul style="list-style-type: none"> • 00005-02298 Front squeegee blade L.830 mm Shore 40 Th. 2.5 mm • 00005-02297 Rear squeegee blade L.870 mm Shore 40 Th. 3 mm | | |
|---|---|---|--|--|

OPTIONAL

| | | | | |
|--|--|--|---|--|
|  <ul style="list-style-type: none"> • 2 x 00055-00149 Tubular battery Pb-acid 12V 118Ah C5 |  <ul style="list-style-type: none"> • 2 x 00055-00130 GEL Battery 12 MFP 105 12V 105Ah C5 |  <ul style="list-style-type: none"> • 00056-00065 Battery Charger 24V 13A 220-240/50-60 |  <ul style="list-style-type: none"> • 10001-08511 On-board Battery charger kit - 24V - 12A |  <ul style="list-style-type: none"> • 00005-02268 Polyurethane front blade L.830 TH. 3 • 00005-02267 Polyurethane rear blade L.870 TH. 4 |
|  <ul style="list-style-type: none"> • 2x 10002-08093 Tynex brush Ø 275 mm-10" • 2x 10002-08094 PP 0,3 brush Ø 275 mm-10" • 2x 10002-08095 PES brush Ø 275 mm-10" |  <ul style="list-style-type: none"> • 2x 10002-08098 Tynex brush Ø 330 mm-13" • 2x 10002-08099 PP 0,3 brush Ø 330 mm-13" • 2x 10002-08100 PES brush Ø 330 mm-13" |  <ul style="list-style-type: none"> • 2x 10002-08096 EWU pad driver Ø 275mm-10" • 2x 10002-08101 EWU pad driver Ø 330mm-13" |  <p>(5 pcs package)</p> <ul style="list-style-type: none"> • 10001-09927 - Ø 280 mm-11"- beige • 10001-09928 - Ø 280 mm-11"- green • 10001-09929 - Ø 280 mm-11"- black |  <p>(5 pcs package)</p> <ul style="list-style-type: none"> • 10001-09911 - Ø 340 mm-13"- beige • 10001-09916 - Ø 340 mm-13"- green • 10001-09921 - Ø 340 mm-13"- black |

Midi-R

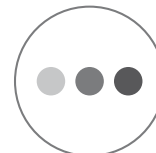

MORE INFO



CHARACTERISTICS

- Capable to work for the maintenance and deep cleaning of large areas (up to 2.600 m²)
- User friendly control panel: forward speed setting, scrubbing and vacuuming selectors, battery charge indicator, traction direction indicator, key main switch
- Large handle with traction driving lever for forward and backward directions
- Self levelling brush plate
- Cover removable without tools
- Quick vacuum motor and filter inspection, without tools
- Detergent solution filter
- Detergent solution tank provided with large opening protected by quick locking cap.
- Quick refilling system

TECHNICAL DATA

| | Midi-R 75BT |
|-------------------------------|-------------------------------|
| code | 37003-00010 |
| power supply | 24V |
| scrubbing/squeegee width | 750/900 mm |
| max working capacity | 4275 m ² /h |
| solution tank capacity | 88 l/23.25 gal |
| recovery tank capacity | 91-95 l/24.04-25 gal |
| traction type/power | automatic/300 W |
| RPM - pressure on the brushes | 150 - 48,5 kg/107.48 lbs |
| brush motor power | 1000 W |
| detergent solution system | solenoid valve |
| depression/vacuum motor | 1733 mmH ₂ O/550 W |
| dimension (cm)/weight | 133x73x117/150 kg |

PLUS



Easy access to battery and vacuum motor compartment, without using tools. Large capacity shock and acid proof polyethylene tanks (88 l) avoid frequent refilling and idle time. 4 x 6V - 180 Ah C5 batteries granting continuous working time up to 4-5 hours.



Adjustable speed ensures high precision in cleaning congested areas with obstacles. Intuitive controls reduce operator's training time. Safety thermal breakers prevent motor problems in case of overheating or operator's misuse.



Heavy duty V-shaped squeegee ensures perfect drying of every type of floor, even with large joints. Non-marking wheels avoid marks after the drying. Completely adjustable to fit any surface.







Strong mechanical control levers for heavy duty use. Large size drain hose for a fast emptying and a better cleaning of the recovery tank. Quick fitting battery charger plug.

STANDARD EQUIPMENT

| | | | | |
|---|--|--|--|--|
|  <ul style="list-style-type: none"> • 2 x 10002-08108 PP brush Ø 360 mm - 14" |  <ul style="list-style-type: none"> • 00005-02240 Front squeegee blade L.925 mm Shore 40 Th. 3 mm • 00005-02237 Rear squeegee blade L.1015 mm Shore 30 Th. 4 mm | | | |
|---|--|--|--|--|

OPTIONAL

| | | | | |
|--|--|--|--|--|
|  <ul style="list-style-type: none"> • 4 x 00055-00013 Tubular battery Pb-acid 6V 180Ah C20 + 2 x 10002-07046 connection cable batteries |  <ul style="list-style-type: none"> • 4 x 00055-00142 Gel battery 6 MFP 180 6V 180Ah C5 + 2 x 10002-07046 connection cable batteries |  <ul style="list-style-type: none"> • 00056-00067 Battery Charger 24V 30A 115-240/50-60 Connection cable batteries 00056-00067 SB50-SB80: 10002-08044 |  <ul style="list-style-type: none"> • 10001-08512 On-board Battery charger kit - 24V - 25A |  <ul style="list-style-type: none"> • 00005-02253 Polyurethane front blade L.925 TH.3 Sh.40 • 00005-02252 Polyurethane rear blade L.1015 TH.4 Sh.40 |
|  <ul style="list-style-type: none"> • 2x 10002-08109 Tynex brush Ø 360 mm-14" • 2x 10002-08110 PP 0,3 brush Ø 360 mm-14" • 2x 10002-08111 PES brush Ø 360 mm - 14" |  <ul style="list-style-type: none"> • 2x 10002-08107 EWU pad driver Ø 360 mm-14" |  <p>(5 pcs package)</p> <ul style="list-style-type: none"> • 10001-09944 - Ø 380 mm-15"- beige • 10001-09945 - Ø 380 mm-15"- green • 10001-09942 - Ø 380 mm-15"- black | | |

Comfort XXS







Model:
37010-00053



Model:
37010-00053
37010-00060









CHARGER

MORE INFO



CHARACTERISTICS

Designed for the maintenance and deep cleaning of large areas (up to 3200 m².) with a very important reduction of cleaning cost. Very compact size and great maneuverability like walk behind models: suited for maintenance cleaning. • 32 kg. of constant pressure on the brushes. • Double counter rotating brush (66 cm of scrubbing width) obtaining better stability and constant pressure. • Great working autonomy thanks to the possibility to use 4 batteries 6 V 240 Ah and to rear wheel-drive. • Large load tank capacity (real load of 85 l.), resulting in reduced numbers of stops and maximum use of battery for effective operation of the machine. • Ergonomic steering wheel of new design with user friendly controls and digital display. • Easy access to electrical components. • Inspection cover for fast and easy cleaning and sanification of dirt water tank. • Automatic device that stops brushes and detergent water outflow when the machine is stationary. • Self-levelling brush plate. • **Automatic detergent dosing system.**

TECHNICAL DATA

| | Comfort XXS 66 BT | Comfort XXS 66 BT | Comfort XXS 66 BT |
|------------------------------|-------------------------------|--------------------------------|--|
| code | 37010-00052 | 37010-00060 | 37010-00053 |
| power supply | 24V | 24V (battery charger included) | 24V (batteries and battery charger included) |
| scrubbing/squeegee width | 660/855 mm | 660/855 mm | 660/855 mm |
| max working capacity | 3250 m ² /h | 3250 m ² /h | 3250 m ² /h |
| solution tank capacity | 80 l/19.81 gal | 80 l/19.81 gal | 80 l/19.81 gal |
| recovery tank capacity | 80-85 l/19.81-21.13 gal | 80-85 l/19.81-21.13 gal | 80-85 l/19.81-21.13 gal |
| traction | rear wheel-drive/400 W | rear wheel-drive/400 W | rear wheel-drive/400 W |
| RPM/pressure on the brushes | 170/32 kg/70.54 lbs | 170/32 kg/70.54 lbs | 170/32 kg/70.54 lbs |
| brush motor power | 2 X 400 W | 2 X 400 W | 2 X 400 W |
| max gradient empty/full tank | 13%/10% | 13%/10% | 13%/10% |
| depression/vacuum motor | 1300 mmH ₂ O/400 W | 1300 mmH ₂ O/400 W | 1300 mmH ₂ O/400 W |
| dimension (cm)/weight | 123x63x121/139 kg | 123x63x121/142 kg | 123x63x121/217 kg |

PLUS



Great working autonomy thanks to the possibility to use 4 batteries 6 V 180 Ah granting continuous working up. Possibility to use also 2 batteries 12V. Less battery consumption thanks to rear wheel-drive. Large load tanks made of shock and acid proof polyethylene (real load of 85 l.), avoiding frequent stop for refilling.



User friendly control panel. Steering wheel with digital controls and display. Squeegee and brush plate mechanical and user friendly lifting lever: min. maintenance cost training time for the users. Scrubbing unit with double brush with brush plate made of steel for a great pressure (32 Kg.) on the floor resulting in an easy and deep cleaning of any kind of dirt.



Detergent solution is cleaned by an external completely accessible filter, that holds any impurities, thus protecting the solenoid valve. The easy access to all internal components of XXS make it possible to reduce maintenance cost. Detergent tank 2lt.



The comfortable and ergonomic seat allows the operator to work effortless for a long time, improving productivity. Its very compact size make it perfect to work in small areas where walk behind models are usually used. The use of XXS makes working easier and quicker with a huge saving of time.

STANDARD EQUIPMENT

| | | | | |
|---|--|--|---|--|
|  <ul style="list-style-type: none"> • 2 x 10002-08102 PP Brush Ø 330 mm - 13" |  <ul style="list-style-type: none"> • 00005-02293 Front squeegee blade L.960 mm Th. 2,5 mm • 00005-02292 Rear squeegee blade L.1000 mm Th. 3 mm |  <ul style="list-style-type: none"> • 00056-00048 On-board Battery charger 24V 20A (only for models code: 37010-00053/37010-00060) |  <ul style="list-style-type: none"> • 2 x 00055-00130 Gel battery 12V 105 A/C 5/120A C20 (only for model code: 37010-00053) | |
|---|--|--|---|--|

OPTIONAL

| | | | | |
|---|--|---|---|--|
|  <ul style="list-style-type: none"> • 4 x 00055-00013 Tubular battery Pb-acid 6V 180Ah C20 + 2 x 10002-07046 connection cable batteries |  <ul style="list-style-type: none"> • 4 x 00055-00142 Gel battery 6 MFP 180 6V 180Ah C5 + 2 x 10002-07046 connection cable batteries |  <ul style="list-style-type: none"> • 2 x 00055-00149 Tubular battery Pb-acid 12V 118 Ah C5 |  <ul style="list-style-type: none"> • 00056-00067 Battery Charger 24V 30A 115-240/50-60 Connection cable batteries 00056-00067 SB50-SB80: 10002-08044 |  <ul style="list-style-type: none"> • 00005-02289 Polyurethane front blade L.960 TH.3 Sh.40 • 00005-02291 Polyurethane rear blade L.1000 TH.4 Sh.40 |
|  <ul style="list-style-type: none"> • 2 x 10002-08098 Tynex brush Ø 330 mm-13" • 2 x 10002-08099 PP 0,3 brush Ø 330 mm-13" • 2 x 10002-08100 PES brush Ø 330 mm - 13" |  <ul style="list-style-type: none"> • 2 x 10002-08101 EWU pad driver Ø 330 mm-13" |  <p>(5 pcs package)</p> <ul style="list-style-type: none"> • 10001-09911 - Ø 340 mm - 13"-beige • 10001-09916 - Ø 340 mm - 13"-green • 10001-09921 - Ø 340 mm - 13"-black |  <ul style="list-style-type: none"> • 10001-09859 Flashing light | <ul style="list-style-type: none"> • 10001-10972 Vacuum kit (on request) |

Comfort XXS Up

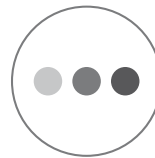

Model:
37010-00076
37010-00079

Model:
Comfort XXS
Up Li

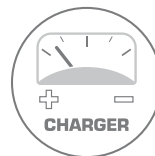

Model:
37010-00076
37010-00079

MORE INFO



CHARACTERISTICS

Designed for the maintenance and deep cleaning of large areas (up to 3200 m².) with a very important reduction of cleaning cost. Very compact size and great maneuverability like walk behind models: suited for maintenance cleaning. • 32 kg. of constant pressure on the brushes. • Double counter rotating brush (66 cm of scrubbing width) obtaining better stability and constant pressure. • Great working autonomy thanks to the possibility to use 4 batteries 6 V 240 Ah and to rear wheel-drive. • Large load tank capacity (real load of 85 l.), resulting in reduced numbers of stops and maximum use of battery for effective operation of the machine. • Ergonomic steering wheel of new design with user friendly controls and digital display. • Easy access to electrical components. • Inspection cover for fast and easy cleaning and sanitification of dirt water tank. • Automatic device that stops brushes and detergent water outflow when the machine is stationary. • Self-levelling brush plate. • **Automatic detergent dosing system.** • **Automatic brush plate and squeegee lifting system**

TECHNICAL DATA

| | Comfort XXS 66 Up | Comfort XXS 66 Up | Comfort XXS 66 Up Li |
|------------------------------|-------------------------------|--|---|
| code | 37010-00075 | 37010-00079 | 37010-00076 |
| power supply | 24V | 24V (batteries and batteries charger included) | 24V (Li-ion battery and battery charger included) |
| scrubbing/squeegee width | 660/855 mm | 660/855 mm | 660/855 mm |
| max working capacity | 3250 m ² /h | 3250 m ² /h | 3250 m ² /h |
| solution tank capacity | 80 l/19.81 gal | 80 l/19.81 gal | 80 l/19.81 gal |
| recovery tank capacity | 80-85 l/19.81-21.13 gal | 80-85 l/19.81-21.13 gal | 80-85 l/19.81-21.13 gal |
| traction | rear wheel-drive/400 W | rear wheel-drive/400 W | rear wheel-drive/400 W |
| RPM/pressure on the brushes | 170/32 kg/70.54 lbs | 170/32 kg/70.54 lbs | 170/32 kg/70.54 lbs |
| brush motor power | 2 X 400 W | 2 X 400 W | 2 X 400 W |
| max gradient empty/full tank | 13%/10% | 13%/10% | 13%/10% |
| depression/vacuum motor | 1300 mmH ₂ O/400 W | 1300 mmH ₂ O/400 W | 1300 mmH ₂ O/400 W |
| dimension (cm)/weight | 123x63x121/139 kg | 123x63x121/139 kg | 123x63x121/142 kg |

PLUS



Great working autonomy thanks to the possibility to use 4 batteries 6 V 180 Ah (mod. 37010-00076/37010-00079) granting continuous working up. Possibility to use also 2 batteries 12V. Less battery consumption thanks to rear wheel-drive. Large load tanks made of shock and acid proof polyethylene (real load of 85 l.)

User friendly control panel. Steering wheel with digital controls and display. Squeegee and brush plate mechanical and user friendly lifting lever: min. maintenance cost training time for the users. Scrubbing unit with double brush with brush plate made of steel for a great pressure (32 Kg.) on the floor resulting in an easy and deep cleaning of any kind of dirt.

Detergent solution is cleansed by an external completely accessible filter, that holds any impurities, thus protecting the solenoid valve. The easy access to all internal components of XXS make it possible to reduce maintenance cost. Detergent tank 2lt.

They provide more power, longer life and much faster charging times. They are not affected by the memory effect and are lighter in weight with lower maintenance costs.

STANDARD EQUIPMENT

| | | | | |
|--|--|---|---|--|
| <ul style="list-style-type: none"> • 2 x 10002-08102 PP Brush Ø 330 mm - 13" | <ul style="list-style-type: none"> • 00005-02293 Front squeegee blade L.960 mm Th. 2,5 mm • 00005-02292 Rear squeegee blade L.1000 mm Th. 3 mm | <ul style="list-style-type: none"> • 00056-00087 On-board Battery charger 24V 30A 115-240V 50/60Hz + 00058-03628 connection cable only for model code: 37010-00076 | <ul style="list-style-type: none"> • 00055-00088 Li-ion battery 55 Ah only for model code: 37010-00076 | |
| <ul style="list-style-type: none"> • 00056-00048 On-board Battery charger 24V 20A only for models code: 37010-00079 | <ul style="list-style-type: none"> • 2 x 00055-00130 Gel battery 12V 105 A/C 5/120A C20 only for models code: 37010-00079 | | | |

OPTIONAL

| | | | | |
|---|--|---|---|--|
| <ul style="list-style-type: none"> • 4 x 00055-00013 Tubular battery Pb-acid 6V 180Ah C20 + 2 x 10002-07046 connection cable batteries | <ul style="list-style-type: none"> • 4 x 00055-00142 Gel battery 6 MFP 180 6V 180Ah C5 + 2 x 10002-07046 connection cable batteries | <ul style="list-style-type: none"> • 2 x 00055-00149 Tubular battery Pb-acid 12V 118 Ah C5 | <ul style="list-style-type: none"> • 00056-00067 Battery Charger 24V 30A 115-240/50-60 Connection cable batteries 00056-00067 SB50-SB80: 10002-08044 | <ul style="list-style-type: none"> • 00005-02289 Polyurethane front blade L.960 TH.3 Sh.40 • 00005-02291 Polyurethane rear blade L.1000 TH.4 Sh.40 |
| <ul style="list-style-type: none"> • 2 x 10002-08098 Tynex brush Ø 330 mm-13" • 2 x 10002-08099 PP 0,3 brush Ø 330 mm-13" • 2 x 10002-08100 PES brush Ø 330 mm - 13" | <ul style="list-style-type: none"> • 2 x 10002-08101 EWU pad driver Ø 330 mm-13" | <p>(5 pcs package)</p> <ul style="list-style-type: none"> • 10001-09911 - Ø 340 mm - 13"-beige • 10001-09916 - Ø 340 mm - 13"-green • 10001-09921 - Ø 340 mm - 13"-black | <ul style="list-style-type: none"> • 10001-09859 Flashing light | <ul style="list-style-type: none"> • 10001-10972 Vacuum kit (on request) |

Comfort XS-R1 Essential

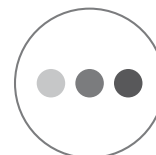

MORE INFO



CHARACTERISTICS

- Capable to work for the maintenance and deep cleaning of large areas (up to 3.700 m²) with a very important reduction of cost of cleaning
- More than 50 kg of constant pressure on the brushes • Large load tank capacity, resulting in reduced number of stops and maximum use of battery charge for effective operation of the machine • Compact size (810 mm) • Stability even when fully loaded, front independent wheeldrive with tight steering radius • Recovery tank control window for cleaning and easy ordinary maintenance • Easy access to electrical components • Automatic device that stops brushes and detergent water outflow when the machine is stationary • Self-levelling brushes. • New control panel • Automatic brush release • Separate eco mode for brush and suction

TECHNICAL DATA

| | Comfort XS-R1 75 Essential | Comfort XS-R1 85 Essential |
|------------------------------|------------------------------|------------------------------|
| code | 37006-00068 | 37006-00070 |
| power supply | 24V | 24V |
| scrubbing/squeegee width | 750/900 mm | 850/1000 mm |
| max working capacity | 4350 m ² /h | 5000 m ² /h |
| solution tank capacity | 110 l/29.05 gal | 110 l/29.05 gal |
| recovery tank capacity | 130-155 l/34.35-40.95 gal | 130-155 l/34.35-40.95 gal |
| traction type/power | front motorwheel/600 W | front motorwheel/600 W |
| RPM/pressure on the brushes | 170/50 kg/110.23 lbs | 170/50 kg/110.23 lbs |
| brush motor power | 2 x 400 W | 2 x 400 W |
| max gradient empty/full tank | 13%/10% | 13%/10% |
| depression/vacuum motor | 1300 mmH ₂ O/400W | 1300 mmH ₂ O/400W |
| dimension (cm)/weight | 146x81x138/184 kg | 146x87x138/187 kg |

PLUS



The detergent water tank serves as battery compartment, allowing the housing of great capacity batteries granting continuous working time up . Large capacity shock and acid proof polyethylene tank (110 l)improves productivity avoiding frequent refilling and idle time.



Simple and intuitive controls reduce operator's training time. Easy mechanical brush plate and squeegee lifting system, for low maintenance costs. The enbloc brush plate apply a very high pressure (50 kg) to the floor, strongly and deeply removing any kind of dirt.



New control panel with digital controls and display. Digital display: with hour meter, battery charge level indicator, empty water tank level indicator, forward/ reverse traction indicator. Speed control adjustment, horn, suction motor switch with delayed switch-off, brush plate lifting/lowering selector switch, brush motor switch.



The ergonomic and comfortable shape of the machine allows the operator to work effortlessly for a long time, improving productivity.

STANDARD EQUIPMENT

| | | | | |
|--|--|--|--|--|
|  <p>Comfort XS-R1 75 • 2 x 10002-08108 PP brush Ø 360 mm - 14"</p> <p>Comfort XS-R1 85 • 2 x 10002-08138 PP brush Ø 430 mm - 17"</p> |  <p>Comfort XS-R1 75 • 00005-02240 Front squeegee blade L.925 mm Shore 40 Th. 3 mm</p> |  <p>Comfort XS-R1 75 • 00005-02237 Rear squeegee blade L.1015 mm Shore 30 Th. 4 mm</p> |  <p>Comfort XS-R1 85 • 00005-02270 Front squeegee blade L.1027 mm Shore 40 Th. 3 mm</p> |  <p>Comfort XS-R1 85 • 00005-02269 Rear squeegee blade L.1150 mm Shore 33 Th. 4 mm</p> |
|--|--|--|--|--|

OPTIONAL

| | | | | |
|--|---|---|--|--|
|  <p>• 4 x 00055-00013 Tubular battery Pb-acid 6V 180Ah C5</p> |  <p>• 4 x 00055-00142 GEL Battery 6 MFP 180 6V 180Ah C5</p> |  <p>• 00056-00067 Battery Charger 24V 30A 115-240/50-60 Connection cable batteries 00056-00067 SB50- SB80: 10002-08044</p> |  <p>• 10001-08560 On-board Battery charger kit 24V - 20A</p> |  <p>• 00005-02253 Polyurethane front blade L.925 TH.3 Sh.40 • 00005-02252 Polyurethane rear blade L.1015 TH.4 Sh.40</p> |
|  <p>• 00005-02273 Polyurethane front blade L.1027 TH.3 • 00005-02274 Polyurethane rear blade L.1150 TH.4</p> |  <p>• 2x 10002-08109 Tynex brush Ø 360 mm-14" • 2x 10002-08110 PP 0,3 brush Ø 360 mm-14" • 2x 10002-08111 PES brush Ø 360 mm - 14"</p> |  <p>• 2x 10002-08118 Tynex brush Ø 430 mm-17" • 2x 10002-08119 PP 0,3 brush Ø 430 mm-17" • 2x 10002-08120 PES brush Ø 430 mm - 17"</p> |  <p>• 2x 10002-08137 EWU pad driver Ø 380 mm-15" • 2x 10002-08121 EWU pad driver Ø 430 mm-17"</p> |  <p>(5 pcs package) • 10001-09944 - Ø 380 mm - 15"- beige • 10001-09945 - Ø 380 mm - 15"- green • 10001-09942 - Ø 380 mm - 15"- black</p> |
|  <p>(5 pcs package) • 10001-09913 - Ø 430 mm - 17"- beige • 10001-09918 - Ø 430 mm - 17"- green • 10001-09923 - Ø 430 mm - 17"- black</p> | | | | |

Comfort XS-R1 Up

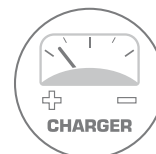
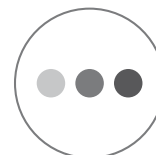

MORE INFO



CHARACTERISTICS

- Capable to work for the maintenance and deep cleaning of large areas (up to 4.000 m²) with a considerable reduction of cleaning costs
- More than 50 kg of constant pressure on the brushes • Large load tank capacity, resulting in reduced number of stops and maximum use of battery charge for effective operation of the machine • Compact size (810 mm) • Stability even when fully loaded, front independent wheeldrive with tight steering radius • Recovery tank control window for cleaning and easy ordinary maintenance • Automatic brush plate lifting system • Automatic squeegee lifting system • Automatic squeegee lifting while reverse going • Automatic device that stops brushes and detergent water outflow when the machine is stationary • Antifoam device • Self-levelling brushes • Integrated on-board battery charger • Automatic brush release • Separate eco mode for brush and suction

TECHNICAL DATA

| | Comfort XS-R1 75 Up | Comfort XS-R1 85 Up |
|------------------------------|--------------------------------|--------------------------------|
| code | 37006-00080 | 37006-00082 |
| power supply | 24V (battery charger included) | 24V (battery charger included) |
| scrubbing/squeegee width | 750/900 mm | 850/1000 mm |
| max working capacity | 4350 m ² /h | 5000 m ² /h |
| solution tank capacity | 110 l/29.05 gal | 110 l/29.05 gal |
| recovery tank capacity | 130-155 l/34.35-40.95 gal | 130-155 l/34.35-40.95 gal |
| traction type/power | front motorwheel/600 W | front motorwheel/600 W |
| RPM/pressure on the brushes | 170/50 kg/110.23 lbs | 170/50 kg/110.23 lbs |
| brush motor power | 2 x 400 W | 2 x 400 W |
| max gradient empty/full tank | 13%/10% | 13%/10% |
| depression/vacuum motor | 1300 mmH ₂ O/400W | 1300 mmH ₂ O/400W |
| dimension (cm)/weight | 146x81x138/189 kg | 146x87x138/195 kg |

PLUS



The easy access to the recovery tank allows fast cleaning and sanitation of the tank; the filling tank together with a large size drain hose allow the complete emptying of the tank and the removal of any type of solid dirt. The antifoam device protects suction motor, as well as the electronic floating switch that stops suction when the tank is full.



All motors are protected by thermal breakers. The detergent water tank serves as battery compartment, allowing the housing of great capacity batteries. Battery charger and suction motor are placed the recovery tank, vacuum motor allows to drastically reduce the operating noise.



Comfort XS-R1 Up is equipped with actuators for the automatic lifting of the brush plate and squeegee. New control panel with digital controls and display. Hour meter, battery charge level indicator, empty water tank level indicator and forward/reverse traction indicator. Speed control adjustment, horn, suction motor







The ergonomic and comfortable shape of the machine allows the operator to work effortless for a long time, improving productivity. Thanks to the compact dimensions the machine can work with agility even in narrow spaces.

STANDARD EQUIPMENT

| | | | | |
|---|--|---|---|--|
|  <p>Comfort XS-R1 75 Up • 2 x 10002-08108 PP brush Ø 360 mm - 14"</p> |  <p>Comfort XS-R1 85 Up • 2 x 10002-08138 PP brush Ø 430 mm - 17"</p> |  <p>Comfort XS-R1 75 Up • 00005-02240 Front squeegee blade L.925 mm Shore 40 Th. 3 mm</p> |  <p>Comfort XS-R1 75 Up • 00005-02237 Rear squeegee blade L.1015 mm Shore 30 Th. 4 mm</p> |  <p>Comfort XS-R1 85 Up • 00005-02270 Front squeegee blade L.1027 mm Shore 40 Th. 3 mm</p> |
|  <p>Comfort XS-R1 85 Up • 00005-02269 Rear squeegee blade L.1150 mm Shore 33 Th. 4 mm</p> |  <p>• 00056-00048 On-board Battery charger 24V 20A (only for model code: 37006-00080/37006-00082)</p> | | | |

OPTIONAL

| | | | | |
|--|--|--|--|---|
|  <p>• 4 x 00055-00013 Tubular battery Pb-acid 6V 180Ah C5</p> |  <p>• 4 x 00055-00142 GEL Battery 6 MFP 180 6V 180Ah C5</p> |  <p>• 00056-00067 Battery Charger 24V 30A 115-240/50-60 Connection cable batteries 00056-00067 SB50-SB80: 10002-08044</p> |  <p>• 00005-02253 Polyurethane front blade L.925 TH.3 Sh.40 • 00005-02252 Polyurethane rear blade L.1015 TH.4 Sh.40</p> |  <p>• 00005-02273 Polyurethane front blade L.1027 TH.3 • 00005-02274 Polyurethane rear blade L.1150 TH.4</p> |
|  <p>• 2x 10002-08109 Tynex brush Ø 360 mm-14" • 2x 10002-08110 Tynex brush Ø 360 mm-14" • 2x 10002-08111 PES brush Ø 360 mm - 14"</p> |  <p>• 2x 10002-08118 Tynex brush Ø 430 mm-17" • 2x 10002-08119 Tynex brush Ø 430 mm-17" • 2x 10002-08120 PES brush Ø 430 mm - 17"</p> |  <p>• 2x 10002-08137 EWU pad driver Ø 380 mm-15" • 2x 10002-08121 EWU pad driver Ø 430 mm-17"</p> |  <p>(5 pcs package) • 10001-09944 - Ø 380 mm - 15"-beige • 10001-09945 - Ø 380 mm - 15"-green • 10001-09942 - Ø 380 mm - 15"-black</p> |  <p>(5 pcs package) • 10001-09913 - Ø 430 mm - 17"-beige • 10001-09918 - Ø 430 mm - 17"-green • 10001-09923 - Ø 430 mm - 17"-black</p> |

Comfort S-R 100

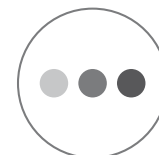

MORE INFO



CHARACTERISTICS

- Suitable for maintenance and deep cleaning of medium and large areas (up to 7.400 m²) with a considerable reduction of cleaning costs
- Large load tank capacity, resulting in reduced number of stops.
- Quick refilling system
- Antifoam device
- High-performance batteries resulting in high-working efficiency.
- Stability even when fully loaded.
- Up to more than 130 kg max of pressure on the brushes (S-R 100 Up)
- Self-levelling brushes
- Front independent wheel-drive with tight steering radius.
- Total wheel protection (S-R 100 Up)
- Cleaning solution distribution by pump (S-R 100 Up)
- Easy access to electrical components
- Automatic brush plate and squeegee lifting system. Automatic squeegee lifting while reverse going
- Automatic device that stops brushes and detergent water outflow when the machine is stationary
- Frontal light (S-R 100 Up)
- Possibility to use Li-ion batteries

TECHNICAL DATA

| | Comfort S-R 100 | Comfort S-R 100 Up |
|------------------------------|------------------------------|------------------------------|
| code | 37007-00025 | 37007-00027 |
| power supply | 36V | 36V |
| scrubbing/squeegee width | 1000/1000 mm | 1000/1000 mm |
| max working capacity | 6500 m ² /h | 7400 m ² /h |
| solution tank capacity | 140 l/36.99 gal | 140 l/36.99 gal |
| recovery tank capacity | 150-180 l/39.6-47 gal | 150-180 l/39.6-47 gal |
| traction type/power | front motorwheel/900 W | front motorwheel/1200 W |
| RPM/pressure on the brushes | 150/75 kg max/165 lbs | 150/130 kg max/286 lbs |
| brush motor power | 2 x 700 W | 2 x 700 W |
| max gradient empty/full tank | 10%/8% | 16%/14% |
| depression/vacuum motor | 1734 mmH ₂ O/550W | 1734 mmH ₂ O/550W |
| dimension (cm)/weight | 180x103x150/300 kg | 180x103x150/320 kg |

PLUS



New brush plate 1000 mm for increased working capacity. Implementation of the ECO MODE function for brushes and suction to reduce energy consumption and noise. Acquistop kit to allow solution tank refilling without the operator's presence. Automatic brush attachment and release.



The control electronics allows the pump to be managed according to the specific washing requirements. 1200W motor wheel for increased performance in terms of speed and climbing ability. Parking brake to ensure the necessary safety in case of steep slopes. Pressure control on the brush plate up to 130Kg.



Quick lock recovery tank cap allows for fast and easy cleaning and sanitation of the tank; the tilting tank together with a large size drain hose allow the complete emptying of the tank and the removal of any type of solid dirt. The antifoam device protects suction motor, as well as the electronic floating switch that stops suction when the tank is full.

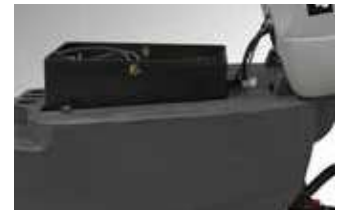





70 kg of continuous brush plate pressure with Self Leveling System to strongly and deeply removing any kind of dirt on any kind of floor. Strong oil-proof polyurethane wheels. 36V 300 Ah C5 battery box allowing continuous working time up to 5 hours. Possibility to use Li-Ion batteries.

STANDARD EQUIPMENT

| | | | | |
|---|--|---|---|--|
|  <ul style="list-style-type: none"> • 2 x 10002-13159 PP brush Ø 457 mm - 18" |  <ul style="list-style-type: none"> • 00005-02270 Front squeegee blade L.1027 mm Shore 40 Th. 3 mm |  <ul style="list-style-type: none"> • 00005-02269 Rear squeegee blade L.1150 mm Shore 33 Th. 4 mm | <ul style="list-style-type: none"> • 2x 00072-00423 red bumper | |
|---|--|---|---|--|

OPTIONAL

| | | | | |
|---|---|---|--|--|
|  <ul style="list-style-type: none"> • 00055-00108 Battery box Pb-acid 36V 300Ah C5 • 00055-00127 Battery box Gel 36V 261Ah C5 | <ul style="list-style-type: none"> • 00056-00070 battery charger 36V 60A 230V/50-60Hz 160A |  <ul style="list-style-type: none"> • 00005-02273 Polyurethane front blade L.1027 TH. 3 • 00005-02274 Polyurethane rear blade L.1150 TH. 4 |  <ul style="list-style-type: none"> • 2x 10002-13160 Tynex brush Ø 483 mm-19" • 2x 10002-13161 PP 0,3 brush Ø 483 mm-19" • 2x 10002-13162 PES brush Ø 483 mm - 19" |  <ul style="list-style-type: none"> • 10002-13163 - 2x EWU pad driver Ø 488 mm-19" |
|  <p>(5 pcs package)</p> <ul style="list-style-type: none"> • 10001-11427 - Ø 488 mm-19"-beige • 10001-11428 - Ø 488 mm-19"-green • 10001-11429 - Ø 488 mm-19"-black | | | | |

Comfort M

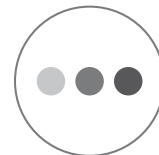

MORE INFO



CHARACTERISTICS

- Suitable for maintenance and deep cleaning of medium and large areas (up to 6.000 m²)
- More than 90/120 kg of constant pressure on the brushes
- Large load tank capacity, resulting in reduced number of stops and maximum use of battery charge for effective operation of the machine
- Stability even when fully loaded
- Front independent wheel-drive with tight steering radius
- Easy access to electrical components
- Automatic brush plate lifting system
- Automatic squeegee lifting system
- Automatic squeegee lifting while reverse going
- Automatic control system for brush rotation and detergent water outflow
- Antifoam device
- Self-levelling brush plate
- Hour meter
- High-performance batteries resulting in high-working efficiency.
- Quick refilling system

TECHNICAL DATA

| | Comfort M 102 |
|------------------------------|-------------------------------|
| code | 37009-00005 |
| power supply | 36V |
| scrubbing/squeegee width | 1020/1250 mm |
| max working capacity | 7140 m ² /h |
| solution tank capacity | 200 l/52.84 gal |
| recovery tank capacity | 210-240 l/55.5-63.4 gal |
| traction type/power | front motorwheel/900 W |
| RPM/pressure on the brushes | 150/120 kg/246 lbs |
| brush motor power | 1500 W |
| max gradient empty/full tank | 10%/8% |
| depression/vacuum motor | 1800 mmH ₂ O/550 W |
| dimension (cm)/weight | 190x112x145/342 kg |

PLUS



The unique anti foam device dramatically reduces the foam generation and prevents it from touching the suction motor, thus protecting its operation. The electronic floating switch stops suction when the tank is full. Large tank opening for fast and easy cleaning and sanitation.



The strong V-shaped floor squeegee made of steel profile is widely adjustable and allows to combine the operation of the rubber blades with the high suction power, to get a perfect drying result on every surface. The special filter box retains solid debris and prevents the obstruction of the suction hose.



Easy to use thanks to the simple and user friendly controls. From the control panel the operator can adjust the maximum forward speed and the quantity of cleaning solution outflow, selecting the options most suitable to the dirt type. Job is simplified and made faster by the automatic lifting of the squeegee and of the brush plate.







Thanks to the optimal weight distribution and to the use of strong oil-proof polyurethane wheels the drive is perfect in all working conditions. The emptying of the solution water tank is quick with a simple and easy accessible mechanical tap.

STANDARD EQUIPMENT

| | | | | |
|---|--|---|--|--|
|  <ul style="list-style-type: none"> • 2 x 10002-13270 PP brush Ø 483 mm - 19" |  <ul style="list-style-type: none"> • 00005-02220 Front squeegee blade L.1270 mm Shore 40 Th. 4 mm |  <ul style="list-style-type: none"> • 00005-02219 Rear squeegee blade L.1345 mm Shore 33 Th. 6 mm | | |
|---|--|---|--|--|

OPTIONAL

| | | | | |
|---|--|---|--|--|
|  <ul style="list-style-type: none"> • 00055-00115 Battery box Pb-acid 36V 360Ah C5 • 00055-00150 Gel battery box 36V 320Ah C5 | <ul style="list-style-type: none"> • 00056-00070 Battery Charger 24V/36V 50/60A - 220-240/50-60 |  <ul style="list-style-type: none"> • 00005-02263 Polyurethane front blade L.1270 TH. 4 • 00005-02249 Polyurethane rear blade L.1345 TH. 6 |  <ul style="list-style-type: none"> • 2x 10002-08128 Tynex brush Ø 483 mm-19" • 2x 10002-08129 PP 0,3 brush Ø 483 mm-19" • 2x 10002-08130 PES brush Ø 483 mm - 19" |  <ul style="list-style-type: none"> • 2x 10002-08131 EWU pad driver Ø 483 mm-19" |
|  <p>(5 pcs package)</p> <ul style="list-style-type: none"> • 10001-09914 - Ø 483 mm - 19"-beige • 10001-09919 - Ø 483 mm - 19"-green • 10001-09924 - Ø 483 mm - 19"-black | | | | |

Comfort L

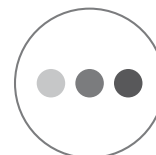

MORE INFO



CHARACTERISTICS

- Suitable for maintenance and deep cleaning of medium and large areas (up to 7.000 m²)
- More than 120-170 kg of constant pressure on the brushes
- 300 litres solution tank capacity allows exceptional autonomy and productivity
- Stability even when fully loaded
- Innovative traction system with three independent motor wheels controlled by electronic cards
- Easy access to electrical components
- Automatic brush plate lifting system
- Automatic squeegee lifting system
- Automatic squeegee lifting while reverse going
- Automatic control system for brush rotation and detergent water outflow
- Antifoam device
- Self-levelling brushes, hour meter, solenoid valve. High-performance batteries resulting in high-working efficiency.
- Quick refilling system

TECHNICAL DATA

| | Comfort L 122 |
|------------------------------|-------------------------------|
| code | 37005-00002 |
| power supply | 36V |
| scrubbing/squeegee width | 1220/1450 mm |
| max working capacity | 8540 m ² /h |
| solution tank capacity | 280 l/73.97 gal |
| recovery tank capacity | 315-340 l/83.2-89 gal |
| traction type/power | 3-wheels drive/3 x 600 W |
| RPM/pressure on the brushes | 150/170 kg/374 lbs |
| brush motor power | 3 x 1000 W |
| max gradient empty/full tank | 10%/8% |
| depression/vacuum motor | 1800 mmH ₂ O/600 W |
| dimension (cm)/weight | 222x130x169/607 kg |

PLUS



Designed to perform the hardest work and to resist even to extreme stresses with maximum comfort; the frame is made of steel profiles with a thickness varying from 5 to 12 mm, protected with a high resistance corrosion-proof paint.



The unique anti foam device dramatically reduces the foam generation and prevents it from touching the suction motor, thus protecting its operation. The electronic floating switch stops suction when the tank is full. Large tank opening for fast and easy cleaning and sanitation.



The cleaning solution tank with an exceptional capacity of 300 liters and the high autonomy of the battery ensure a productivity at the top of the range. The wide rear opening allows for an easy and quick refilling of the cleaning solution tank.







The motorwheels, designed and built by Lavor, grant optimal performances and exceptional reliability (over 30.000 hours). The innovative three-wheel drive system ensures perfect traction in every operating condition.

STANDARD EQUIPMENT

| | | | | |
|---|--|---|--|--|
|  <ul style="list-style-type: none"> • 3 x 10002-08112 PP brush Ø 406 mm - 16" |  <ul style="list-style-type: none"> • 00005-02222 Front squeegee blade L.1500 mm Shore 40 Th. 4 mm |  <ul style="list-style-type: none"> • 00005-02221 Rear squeegee blade L.1580 mm Shore 33 Th. 6 mm | | |
|---|--|---|--|--|

OPTIONAL

| | | | | |
|---|--|---|---|--|
|  <ul style="list-style-type: none"> • 00055-00137 Battery box Pb-acid 36V 525 Ah C5 • 00055-00101 Gel battery box 36V 400 Ah C5 | <ul style="list-style-type: none"> • 00056-00070 Battery Charger 24V/36V 50/60A - 220-240/50-60 |  <ul style="list-style-type: none"> • 00005-02264 Polyurethane front blade L.1500 TH. 4 • 00005-02265 Polyurethane rear blade L.1580 TH. 5 |  <ul style="list-style-type: none"> • 3x 10002-08113 Tynex brush Ø 406 mm-16" • 3x 10002-08114 PP 0,3 brush Ø 406 mm-16" • 3x 10002-08115 PES brush Ø 406 mm - 16" |  <ul style="list-style-type: none"> • 3x 10002-08116 EWU pad driver Ø 406 mm-16" |
|  <p>(5 pcs package)</p> <ul style="list-style-type: none"> • 10001-09912 - Ø 406 mm - 16"-beige • 10001-09917 - Ø 406 mm - 16"-green • 10001-09922 - Ø 406 mm - 16"-black | | | | |

Comfort Duotech / 3 in 1

Sweeps | Washes | Dries

HOW DOES DUOTECH WORK?

The collection of dust and debris during the washing of the floor takes place simultaneously with the anti-clockwise action of the cylindrical brush with adjustable pressure. The debris, together with the washing solution mixed with the dirt collected, are collected in the underlying compartment from which they are sucked up and conveyed into specific collection containers. The remaining film of water that escapes the primary collection is then sucked in by a second motor.

The collection, suction and washing solution system is the real heart of the Comfort Duotech.

The solution is atomized by the variable delivery nozzles in a uniform quantity adjacent to the washing roller. The exhaust air of the two suction motors is conveyed and blown through the side diffusers.

The roller, rotating anti-clockwise, together with the diffusers allow to keep a smaller quantity of solution for a long time for a superior washing and at the same time much cheaper and faster than traditional methods.

The perfect drying of the Comfort Duotech when cornering is also achieved thanks to the automatic translation of the wiper and side brushes during the steering action.

The solution consumption per minute of Comfort Duotech ranges from 500ml to 1500ml (in the case of large concentrations of dirt), compared to 1500-4500ml per minute for competing machines.

Innovation enables reduced water and detergent consumption amounting to 50% less than traditional systems with roller brushes that require multiple ducts to deliver the solution over the entire length of the brush and consequently cause high dispersion and consumption.

In the innovative patented AIR RECOVERY principle, this advantage is achieved by recovering the suction motors air return, which is conveyed and compressed in the left and right sides in front of the central brush. In this way, by using only two nozzles that deliver a

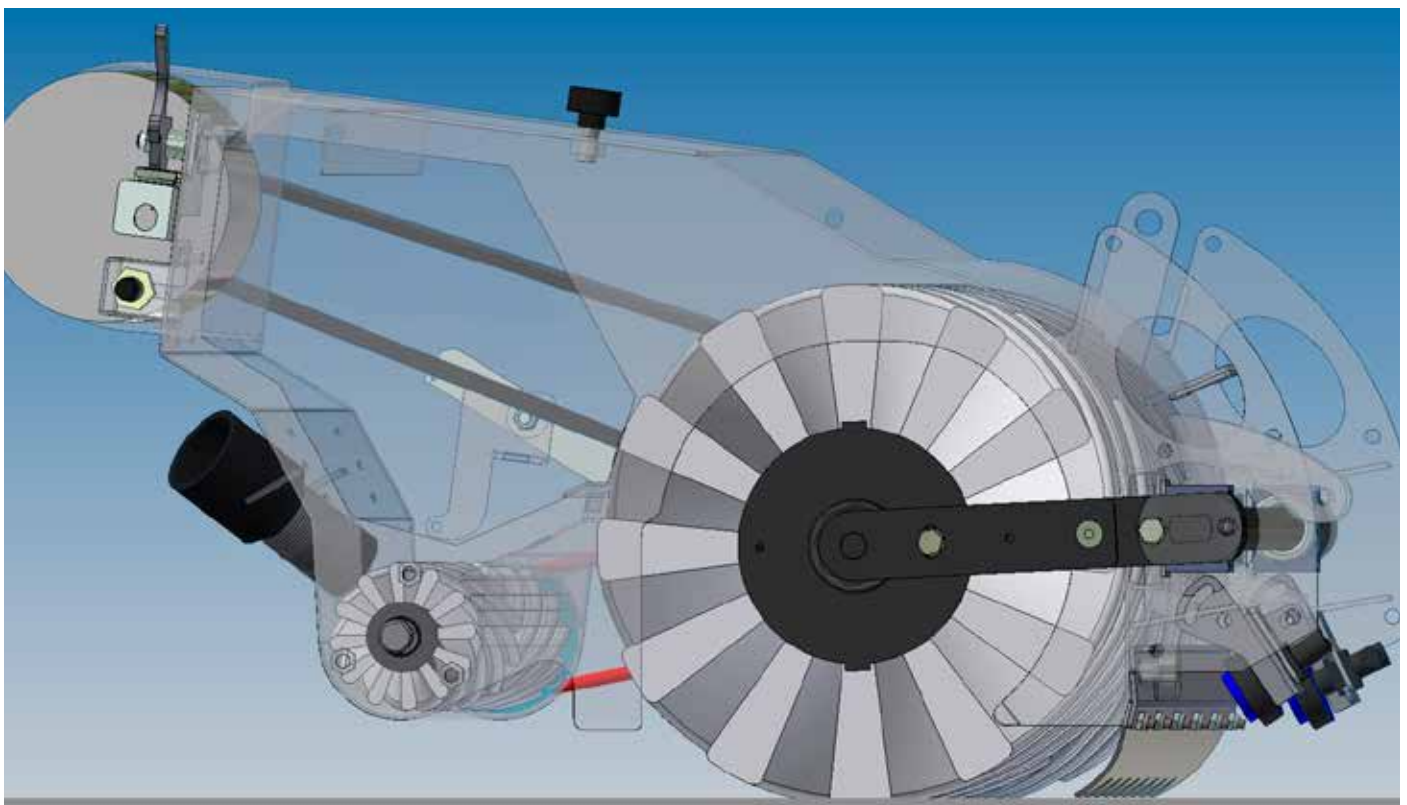

calibrated amount of solution), it is possible to deliver the solution over the entire width of the brush and keep a constant accumulation of cleaning solution in front of the brush.

Compressed air helps preventing lateral dispersion of the water/detergent solution

Debris is conveyed upward and into the perforated drawer. Unlike the other roller scrubber driers, the central roller turns very fast (about 950 rpm) and also conveys dirty water; this does not return to the floor but flows into a tank where a small helical brush is located. The function of this brush is conveying the muddy water to the centre where the suction pipe is located.

EVO draws the 85% of the water directly from the central brush. The only function of the rear is completing the drying for the remaining 15% of water left on the floor.

EVO allows easy access to all its components for any action required.

The tanks can easily be tipped over so that they can be washed and sanitised inside.

TO WHAT AND TO WHOM COMFORT DUOTECH IS PARTICULARLY ADDRESSED TO?

Considering the features and performances described above, Comfort Duotech is particularly suitable for cleaning very dirty surfaces, even in presence of heavy debris that need to be swept before being washed.

Comfort Duotech is also fit to clean uneven surfaces. It is apt to sweep, wash and dry areas where delicate packaging or goods packed into carton boxes are stored and operator's attention is required while working nearby.

Thanks to its great speed and work autonomy as well as its superior sturdiness and reliability, not to mention user friendli-ness, Comfort Duotech is the ideal machine for companies that provide cleaning services and often use heterogeneous staff, subject to frequent rotation and therefore not always well trained. Then in order to summarize some possible uses and identify potential users Comfort Duotech suits to:

- Warehouses and stores
- Factories, plants and workshops
- Railways stations
- Airports
- Parking areas
- Shopping malls
- Supermarkets
- Cleaning contractors



Comfort Duotech

NEW



MORE INFO



CHARACTERISTICS

• **Comfort Duotech it is a 3 in 1 machine: it sweeps, washes, and dries** • Ultra compact dimensions and great handling like a walk behind scrubber dryer, ideal for maintenance cleaning • Complete right/left side brush (1060 mm working width) • Great battery autonomy (up to 4h) thanks to the very low consumption of washing solution and tanks large capacity • Very precise detergent dosing system, proportional to the water supply, which determines a reduced number of stops and maximum use of the battery charge for the effective operation of the machine • Ergonomic steering wheel of new conception with very small turning radius (860mm) which allows it to rotate practically on itself both to the right and to the left • Self-leveling central brush that allows perfect work even on uneven surfaces • Forced air flows keep the solution always within the washing track patented • Sweeping, up to 1060mm, thanks to large diameter and intelligent side brushes (Active) which retract automatically both in the event of an impact and when cornering to allow the perfect collection of all the material. • Up to 30 L solid debris tank • Double floor drying process that allows the rear wheels to travel without slipping on wet surfaces. • Green feature: very low water consumption • Seat hight kit available • **Raised seat kit standard (only code 37025-00010)**

TECHNICAL DATA

| | Comfort Duotech 85 CS | Comfort Duotech 85 CS RS |
|--------------------------------------|-----------------------------------|-----------------------------------|
| code | 37025-00004 | 37025-00010 |
| power supply | 24V | 24V |
| cleaning width with right side brush | 880 mm | 880 mm |
| cleaning width with two side brushes | 1060 mm | 1060 mm |
| scrubbing width/squeegee width | 850/900 mm | 850/900 mm |
| max working capacity | 6160 m ² /h | 6160 m ² /h |
| turning radius | 860 mm | 860 mm |
| clean water tank capacity | 75 l/19,8 gal | 75 l/19,8 gal |
| dirty water tank capacity | 80 l/21,1 gal | 80 l/21,1 gal |
| chemical tank capacity | 3 l/0,79 gal | 3 l/0,79 gal |
| solid waste container capacity | 30 l/7,92 gal | 30 l/7,92 gal |
| working speed/max | 4/5,5 km/h | 4/5,5 km/h |
| max gradient/power | 12%/2800W | 12%/2800W |
| main brush size | Ø300 x L 850 mm | Ø300 x L 850 mm |
| main brush speed | 900 RPM/min | 900 RPM/min |
| main brush pressure | adjustable from the control panel | adjustable from the control panel |
| dimension (cm)/weight | 140x105x130/374 kg | 140x105x130/374 kg |

PLUS



Control panel with easy and intuitive controls featuring: hour meter, battery charge level indicator, empty tank light and forward/reverse drive indicator. Speed adjustment, horn, main brush pressure adjustment, automatic squeegee height adjustment. Detergent dosing system.



Sturdy and large central brush d.300 self-levelling, with adjustable pressure and anti-clockwise rotation. Stainless steel brush assembly. Innovative AIR RECOVERY system (patented), thanks to compressed air channelled in front of the brush: the lateral dispersion of the detergent solution is avoided.



Sturdy steel squeegee system. Perfect drying even in the tightest corners.

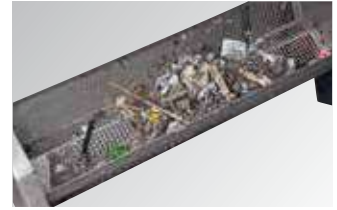



Wide stainless steel 30 l collector tank it allows collecting solid debris.

STANDARD EQUIPMENT

| | | | | |
|---|--|---|---|--|
|  <ul style="list-style-type: none"> • 00080-04645 Main brush PPL/Tynex Duotech 85 |  <ul style="list-style-type: none"> • 2 x 00080-04646 PPL side brush dx/sx |  <ul style="list-style-type: none"> • 00005-02341 Front squeegee blade Duotech 85 LINATEX@/AIROFLEX |  <ul style="list-style-type: none"> • 00005-02340 Rear squeegee blade Duotech 85 LINATEX | |
|---|--|---|---|--|

OPTIONAL

| | | | | |
|--|--|---|--|---|
| <p>Only for model 37025-00004</p>  <ul style="list-style-type: none"> • 4x00055-00120-Battery box Pb-Acid 6V 240Ah C5 +00071-05303 metal box for battery  <ul style="list-style-type: none"> • 00056-00067 Battery Charger 24V 30A 115-240/50-60 for 00055-00120 + 10002-08044 Connection cable batteries SB50-SB80 | | <p>Only for model 37025-00010</p>  <ul style="list-style-type: none"> • 1x00055-00085 Battery box Pb-Acid 24V 320Ah C5 • 1x00055-00086 Battery box Pb-Acid 24V 360Ah C5*  <ul style="list-style-type: none"> • 1x00055-00087-GEL Battery box 24V 320Ah C5 GEL*  <ul style="list-style-type: none"> • 00056-00069 Battery charger 24V-60A 230V 50-60 Hz suggested for 360-320Ah battery models | | |
|  <ul style="list-style-type: none"> • 00080-04650 Main brush PPL Duotech 85 | <ul style="list-style-type: none"> • 00056-00069 Battery charger 24V-60A 230V 50-60 Hz suggested for 360-320Ah battery models | <ul style="list-style-type: none"> • 10001-10901 Automatic battery 240Ah topping up set • 10001-10902 Automatic battery 320/360Ah topping up set | <ul style="list-style-type: none"> • On Board Battery Charger 24V 20-35AH (on request) | <ul style="list-style-type: none"> • Front working light system (on request) |
| <ul style="list-style-type: none"> • 00072-00390 Seat belt | <ul style="list-style-type: none"> • Complete red Roll Bar model 85 (on request) | <ul style="list-style-type: none"> • Complete red Roll Bar with sheet metal shed model 85 (on request) | <ul style="list-style-type: none"> • 10001-10903 raised seat kit in conjunction with 00055-00086* or 00055-00087* | |



FMS

Fleet Management System

Lavor's **Fleet Management System** allows having your entire fleet of floor scrubbers and sweepers in a cloud on the Web or mobile. **FMS** shows the current status of your fleet by providing all useful, real-time data on the operator's driving status and machines' condition. A simple and intuitive dashboard shows all the information needed to measure machine efficiency and productivity:

Battery monitoring

You can view the progress of battery charging and discharging. In models equipped with a current sensor, the AH delivered power consumption can be displayed.



Work area: management of business areas

You can know the location, status and activities of the machines in real time while setting the work areas. The configuration of areas is totally customizable; in fact, a work area of any shape and size can be drawn on the map, outside of which the machine may reduce its functions.



Mobile app for real-time monitoring

A service (for consultation purposes only, for now) allows users to display the portal homepage, machine section, alarm section and map section. In addition, the **Fleet Management System** comes along with a primary appraisal that will certify the system for the purchaser, detailing the system itself.



THE TECHNOLOGIES INCLUDED OFFER MULTIPLE BENEFITS

- Increased productivity through shorter set-up times, reduced errors and downtime
- Improved quality of operation and maintenance
- Increased product competitiveness due to IOT-derived advanced features.

FLOOR SCRUBBER DRIERS FMS RANGE

| | |
|-------------|---|
| 37031-00103 | FREE EVO 50BT with batteries charger - FMS |
| on request | MOVING 55BT with batteries charger - FMS |
| 37010-00048 | COMFORT XXS 66 with batteries charger / with batteries - FMS |
| 37010-00046 | COMFORT XXS 66 UP Li with battery charger / with battery Li-ion - FMS |
| 37006-00098 | COMFORT XS-R1 75 UP with batteries charger - FMS |
| 37006-00101 | COMFORT XS-R1 85 UP with batteries charger - FMS |
| 37007-00031 | COMFORT S-R 100 UP - FMS |
| 37009-00034 | COMFORT M 102 - FMS |
| 37025-00008 | DUOTECH 85 CS - FMS |



Is it better a petrol engine driven or a battery powered model?

The use of a petrol engine implies the presence of exhaust gasses and therefore the machine must be used only in outside areas or in areas where the operator is not exposed at such risk. The battery models can be used also inside. From the technical and qualitative point of view the sweepers do exactly the same cleaning task, but the petrol engine machine can work nonstop (it is only necessary to fill up the tank with petrol), while the electric models, once the battery is empty, need to be re-charged (an average of 8-10 hours of charge, if battery is completely worn-out)

How should the brush be be?

In the sweepers, there are two types of bushes: the first one rotates with a perpendicular axle to the floor (this is the one called "side brush"), it is useful to move dirt into the collecting area and to reach dirt near borders or under edges; the second one rotates with a parallel axle to the floor (this is the one called "main brush"); it rotates counterclockwise (opposite) to the forward direction of machine and collects dirt into the collection tank. The brushes differ in the shape (round flat the "side brush" and cylindrical the "main brush"), in the type of bristles (the way bristles are arranged on the brush body), in the body material (that accordingly to options, provides resistance still in humid environment or competitive construction) and in the bristle material/diameter/shape. Generally, the stiffer and rougher the bristles are, the better they collect the heaviest dirt adherent to the floor (typically wet leaves). The more flexible and thinner the bristles are, the better they collect light and thin dirt. To have a better scraping action, it is necessary to add steel bristle to the PP ones. To collect very thin dirt, it is necessary to use only short round PP bristles. As a consequence of motorization (petrol engine or electric one) and so of indoor or outdoor use, the walk behind models have stiffer or softer bristles, to adapt in best way possible to the type of dirt typically found in the working area.

How long do battery charges last?

It is impossible to determine exactly how long a battery charge

lasts.

Battery autonomy changes depending on type of surface, dirt quantity, brush type and way in which traction system is used (speed and slope).

Battery life is made up of number of charge cycles (also incomplete), if use conditions, charge and service are perfectly observed.

Manufacturing technology diversifies numbers of cycles, service needed, use/charge conditions and performances.

Which kind of battery technology?

Batteries have different prices and so it is important to know their features in order to choose the best one as far as the operator's needs or habits are concerned.

They divide into two families according to the necessity of recurrent acid solution refilling.

Acid lead batteries (Pb-Acid), need refilling, because during the charge cycle a lot of gasses are generated (for this reason a specific and aired room is necessary for safe working) and the solution vaporizes: it is necessary to add

distilled water before the submerged

lead parts that are no more covered with water begin to oxidize (compromised efficiency).

VRLA batteries (Valve Regulated Lead Acid) are airtight, this means that gasses generated during the charge cycle are

rearranged inside the battery:

refilling is not necessary, it is possible to charge them

in any room and they can be carried without risk.

Acid lead batteries divide themselves into categories

depending on the thickness of plate they are built of: if the plate is plane, the resistance to discharge is lower and few charge cycles are necessary, if the plate is tubular (or armed, recognizable opening the battery cap and verifying that the plate is made up of a lot of cylinders side by side instead of a thin leaf sheet) there is a higher resistance to discharge and to charge cycles.

VRLA batteries divide themselves depending on the condition (liquid or gel) of the acid solution (that enables energy exchange) and on the way it is kept inside the





- **Belt drive**

The circular section grants a high resistance, stillness, reliability and it doesn't need service.



- **Side brush exclusion**

It is a system protecting bristles during machine stop or whenever it is not necessary to use it.



- **Dust vacuum system**

It can be found in the main brush area. Together with the mechanical action, it conveys waste and dust that are collected into the tank through the right filters supplied.



- **Front dust vacuum system**

As well as traditional vacuum system, a vacuum system can be found in the lateral brush/es collection area. Dust dispersion outside the machine is limited also before the main collection area is reached.



- **Flap raise system**

The main brush collection area is delimited by protections (flaps) touching the ground, better vacuum effect. When a big residual is possible to raise the flap collecting it rather than keep going pushing it on the floor.



- **Filter shaker**

It clears filter from dust without touching it or opening the sweeper; the vacuum efficiency is kept at max, granting the best comfort and output for the user.



- **Lithium batteries as standard**

They provide more power, longer life and much faster charging times.

They are not affected by the memory effect and are lighter in weight with lower maintenance costs.



- **Sanitize system**

Through the action of the nozzles, the sanitizing product is evenly distributed over the surface after the drying system has passed over by reducing the battery charge.

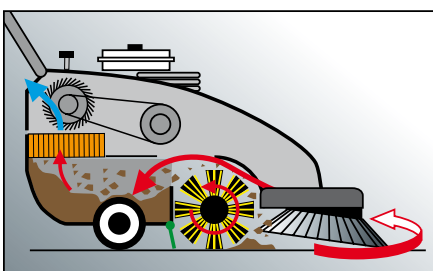

battery: if it is liquid and kept by a spongy and filamentous material, the battery is called AGM; if it is a gel solution inside a membrane, the battery is called GEL battery. On the market there are a lot of products completely different in features and value and it is very important to know the manufacturing details to couple the right battery charger (it is not sure that any battery charger is suited and get a better result than the ones in our range that are specific for our batteries) and to come up to the working expectations.

Nomenclature

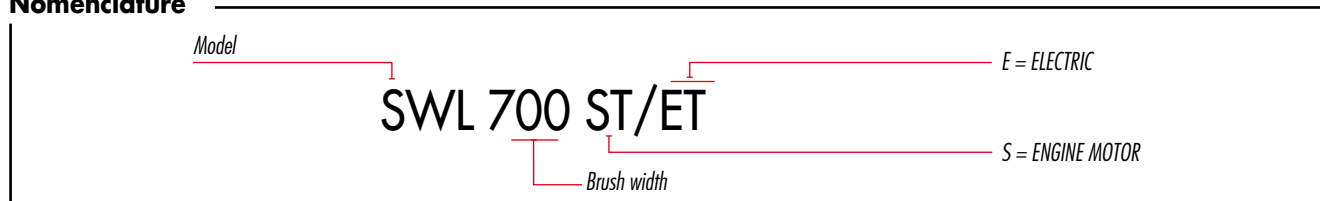

Technical information

| Code | Model | Page | Type | Traction | Main brush width | Main brush + 1 side brush | Main brush + 2 side brushes | Collector tank | Max working capacity | Packaging | Weight with packaging | Weight with packaging | Pcs x pallet |
|-------------|---------------|------|----------------|------------|------------------|---------------------------|-----------------------------|----------------|----------------------|-----------------------|-----------------------|-----------------------|--------------|
| | | | | | mm/inc | mm/inc | mm/inc | | | | | | |
| 39003-00001 | BSW 375 ET | 284 | electric | Manual | 350/13,78 | - | 375/14,76 | 2/0,52 | 1000/10764 | 30x36x11/11x13x4 | 2,8 | 6,16 | 48 |
| 39001-00029 | BSW 950 MF | 286 | manual | Manual | 480/18,89 | - | 950/37,40 | 45/11,8 | 3500/37673 | 120x80x168/47,2x31x66 | 131 | 288 | 4 |
| 39002-00069 | SWL 700 ET | 288 | electric | Mechanical | 510/20,08 | 680/26,77 | - | 45/11,89 | 2620/28201 | 126x63x85/50x25x34 | 78 | 172 | 1 |
| 39002-00070 | SWL 700 ST | 288 | gasoline motor | Mechanical | 510/20,08 | 680/26,77 | - | 45/11,89 | 2620/28201 | 126x63x85/50x25x34 | 77 | 169 | 1 |
| 39002-00071 | SWL 900 ET | 290 | electric | Mechanical | 710/27,95 | 880/34,64 | - | 55/14,52 | 3700/39826 | 126x83x85/50x33x34 | 89 | 196 | 1 |
| 39002-00072 | SWL 900 ST | 290 | gasoline motor | Mechanical | 710/27,95 | 880/34,64 | - | 55/14,52 | 3700/39826 | 126x83x85/50x33x34 | 97 | 213 | 1 |
| 39002-00067 | SWL R 950 ET | 292 | electric | Mechanical | 450/17,7 | 750/29,5 | 1050/41,3 | 50/13,2 | 6000/64583 | 148x86x120/58x33x47 | 225 | 240 | 1 |
| 39002-00064 | SWL R 990 ET | 294 | electric | hydraulic | 700/27,56 | 920/36,22 | 1140/44,8 | 62/16,38 | 6200/66735 | 143x91x114/56x36x45 | 260 | 572 | 1 |
| 39002-00065 | SWL R 990 ST | 294 | gasoline motor | hydraulic | 700/27,56 | 920/36,22 | 1140/44,8 | 62/16,38 | 6200/66735 | 143x91x114/56x36x45 | 300 | 660 | 1 |
| 39002-00074 | SWL R 1000 ET | 296 | electric | hydraulic | 700/27,56 | 920/36,22 | 1230/48,42 | 62/16,38 | 6200/66735 | 143x91x114/56x36x45 | 260 | 572 | 1 |
| 39002-00075 | SWL R 1000 ST | 296 | gasoline motor | hydraulic | 700/27,56 | 920/36,22 | 1230/48,42 | 62/16,38 | 6200/66735 | 143x91x114/56x36x45 | 300 | 660 | 1 |
| 39002-00036 | SWL R 1100 ET | 298 | electric | hydraulic | 800/31,50 | 1050/41,34 | 1300/51,18 | 115/30 | 9700/104409 | 160x101x130/65x43x52 | 375 | 825 | 1 |
| 39002-00033 | SWL R 1100 DT | 298 | Diesel motor | hydraulic | 800/31,50 | 1050/41,34 | 1300/51,18 | 115/30 | 9700/104409 | 160x101x130/65x43x52 | 434 | 955 | 1 |
| 39002-00044 | SWL R 1100 ST | 298 | gasoline motor | hydraulic | 800/31,50 | 1050/41,34 | 1300/51,18 | 115/30 | 9700/104409 | 160x101x130/65x43x52 | 434 | 955 | 1 |



| Code | Model | Page | Type | Traction | Main brush width | Main brush + 1 side brush | Main brush + 2 side brushes | Collector tank | Max working capacity | Packaging | Weight with packaging | Weight with packaging | Pcs x pallet |
|-------------|------------------------|------|----------------|-----------|------------------|---------------------------|-----------------------------|----------------|-----------------------------------|----------------------|-----------------------|-----------------------|--------------|
| | | | | | mm/inc | mm/inc | mm/inc | lt/gal | m ² /foot ² | L x l x H cm/inc | kg | lbs | n° |
| 39002-00043 | SWL R 1100 ET BINUP | 300 | electric | hydraulic | 800/31,50 | 1050/41,34 | 1300/51,18 | 115/30 | 9700/104409 | 160x101x130/65x43x52 | 375 | 825 | 1 |
| 39002-00041 | SWL R 1100 DT BINUP | 300 | Diesel motor | hydraulic | 800/31,50 | 1050/41,34 | 1300/51,18 | 115/30 | 9700/104409 | 160x101x130/65x43x52 | 434 | 955 | 1 |
| 39002-00045 | SWL R 1100 ST BINUP | 300 | gasoline motor | hydraulic | 800/31,50 | 1050/41,34 | 1300/51,18 | 115/30 | 9700/104409 | 160x101x130/65x43x52 | 434 | 955 | 1 |
| 39002-00113 | SWL R 1200 ET BINUP | 302 | electric | electric | 900/35,4 | 1150/45,2 | 1440/56,6 | 180/47,5 | 11500/37729 | 193x134x168/76x53x66 | 750 | 1653 | 1 |
| 39002-00114 | SWL R 1200 DT BINUP | 302 | Diesel motor | electric | 900/35,4 | 1150/45,2 | 1440/56,6 | 180/47,5 | 11500/37729 | 193x134x168/76x53x66 | 870 | 1918 | 1 |
| 39002-00066 | SWL R 1300 DT BINUP | 304 | Diesel motor | hydraulic | 1000/39,3 | 1485/58,4 | - | 490/129 | 19200/206667 | 225x145x154/88x57x60 | 1020 | 2245 | 1 |
| 39002-00128 | SWL R 1300 DT BINUP | 304 | Diesel motor | hydraulic | 1000/39,3 | 1485/58,4 | 1615/63,5 | 490/129 | 19200/206667 | 225x145x154/88x57x60 | 1020 | 2245 | 1 |
| 39002-00105 | SWL R 1300 DT BINUP | 306 | Diesel motor | hydraulic | 1000/39,3 | 1485/58,4 | - | 490/129 | 19200/206667 | 225x145x154/88x57x60 | 1020 | 2245 | 1 |
| on request | SWL R 1300 DT BINUP | 306 | Diesel motor | hydraulic | 1000/39,3 | 1485/58,4 | 1615/63,5 | 490/129 | 19200/206667 | 225x145x154/88x57x60 | 1020 | 2245 | 1 |
| on request | SWL R 1300 DT BINUP | 308 | Diesel motor | hydraulic | 1000/39,3 | 1485/58,4 | - | 490/129 | 19200/206667 | 225x145x154/88x57x60 | 1020 | 2245 | 1 |
| on request | SWL R 1300 DT BINUP | 308 | Diesel motor | hydraulic | 1000/39,3 | 1485/58,4 | 1615/63,5 | 490/129 | 19200/206667 | 225x145x154/88x57x60 | 1020 | 2245 | 1 |
| 39002-00111 | SWL R 1300 DT AC BINUP | 308 | Diesel motor | hydraulic | 1000/39,3 | 1485/58,4 | - | 490/129 | 19200/206667 | 225x145x154/88x57x60 | 1020 | 2245 | 1 |
| on request | SWL R 1300 DT AC BINUP | 308 | Diesel motor | hydraulic | 1000/39,3 | 1485/58,4 | 1615/63,5 | 490/129 | 19200/206667 | 225x145x154/88x57x60 | 1020 | 2245 | 1 |



BSW 375 ET

Space-saving storage position.

MORE INFO

**CHARACTERISTICS**

• Industrial battery-powered sweeper for the quick, quiet and cordless intermediate cleaning of all surfaces, indoor and outdoor. • Ideal for entryways of all kinds, hallways, staircases, driveways, warehouse and office areas, airports and train stations. • Equipped with two batteries, the operation time lengthens to 90 minutes. • The powerful Lithium-Ion battery (without memory effect) with 10.8 V and 1.5 Ah allows an operation time of approx. 45 minutes per battery. • Second battery can be directly stored and carried on the machine itself. • Quick-charging unit with a charging time of only 70 minutes is included with purchase. • Large foot pedal for activation without bending over. • Main cylinder brush and side brushes can be replaced without tools. • Aluminum telescopic handle for an optimum work position. • Traceless wheels. • Enormous waste collection tray with 2 liter capacity. • Changeable bristled rim on the underside of the housing. • Low noise volume, and therefore excellent for use during business hours. • Compact, light, and easy-to-handle for any user.

TECHNICAL DATA

| | BSW 375 ET |
|---------------------------------|---|
| code | 39003-00001 |
| main brush + 2 side brush width | 375mm/14,76 inc |
| collector tank | 2 lt/0,52 gal |
| max working capacity | 1000 m ² /h-10764 ft ² /h |
| operating voltage | 10,8V/1,5 Ah |
| max. power | 25 W |
| voltage (charging unit) | 230 V~50 Hz |
| dimension (cm)/weight | 30x36x70/2,8 kg |

PLUS



Main cylinder brush and side brushes can be replaced without tools. Traceless wheels.

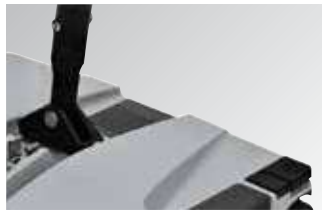

Enormous waste collection tray with 2 liter capacity. Easy to remove. Large foot pedal for activation without bending over.





Quick-charging unit with a charging time of only 70 minutes is included with purchase.



Equipped with two batteries, the operation time lengthens to 90 minutes. Second battery can be directly stored and carried on the machine itself.

STANDARD EQUIPMENT

| | | | | |
|--|---|---|--|--|
|  <ul style="list-style-type: none"> • 00080-04148 Cylinder brush |  <ul style="list-style-type: none"> • 2x 00080-04149 Side brush l/r |  <ul style="list-style-type: none"> • 2 x 00055-00129 10.8V Lithium-Ion battery |  <ul style="list-style-type: none"> • 00056-00096 Battery charger | |
|--|---|---|--|--|

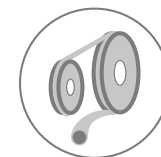
BSW 950 MF

MORE INFO

**CHARACTERISTICS**

- Ideal for small and medium surfaces • Easy handling • Wide collector tank with Filtering system • Rear collector tank with filter • Side brush lifting
- Main brush pressure regulation • Separate side brush • Adjustable working load on the brush • Tilting handle • 360° front wheel • Shock proof frame • Hourly efficiency (max) 3500 m²/h. • Working area (2 side brush) 480 (950) mm • Cartridge filter with fan for dust extraction

TECHNICAL DATA

| | BSW 950 MF |
|-----------------------------|---|
| code | 39001-00029 |
| main brush width | 480 mm / 18,90 inch |
| main brush + 2 side brushes | 950 mm / 37,40 inch |
| collector tank | 45 lt./ 11,88 gal |
| max working capacity | 3500 m ² /h / 37673 ft ² /h |
| traction | manual |
| brushes transmission | elastic belt |
| pressure on the brushes | adjustable |
| side brush | lifting arm system |
| dust-laying system | direct |
| filtering system | pleated figer |
| dimension (cm)/weight | 97x93x128 / 25kg |

PLUS



Main brush with pressure regulation. Side brush lifting with pressure regulation system.



Wide collector tank with pleated filtering system. Rear collector tank with cartridge filter with fan for dust extraction



360° front wheel and heavy-duty shock proof frame



Tilting handle with sturdy storage bag

STANDARD EQUIPMENT

| | | | | |
|--|--|---|---|--|
|  <ul style="list-style-type: none"> • 00080-04150 PP |  <ul style="list-style-type: none"> • 00080-04151 PP |  <ul style="list-style-type: none"> • 00070-00451 Tank filter |  <ul style="list-style-type: none"> • 10001-07853 Cartridge filter with fan for dust extraction standard | |
|--|--|---|---|--|

SWL 700**POWERED by HONDA™**

Only model 700 ST

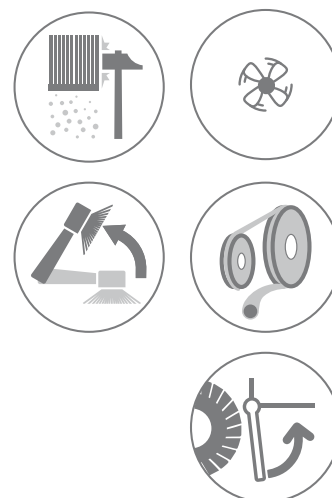

MORE INFO

**SWL 700 ST**

MORE INFO

**SWL 700 ET****CHARACTERISTICS**

- Ideal for medium and large surfaces
- Large filter surface with electric filter shaker (ET model)
- Manual filter shaker (ST model)
- Side brush raising control
- Suction switch off
- Flap raise system
- Panel filter in horizontal position
- Main brush pressure regulation
- Indirect back collection
- Quick main brush release
- Long life elastic belts
- Reclining handle
- Suction selection lever
- Traction lever
- Antistatic device
- Wide collector tank
- Heavy duty steel frame
- Side brush mechanical engagement
- Battery and battery charger not included.

TECHNICAL DATA

| | SWL 700 ET | SWL 700 ST |
|---------------------------------|---|---|
| code | 39002-00069 | 39002-00070 |
| main brush width | 510mm / 20,08 inc | 510mm / 20,08 inc |
| main brush + 1 side brush width | 680mm / 26,77 inc | 680mm / 26,77 inc |
| collector tank | 45 lt / 11,89 gal | 45 lt / 11,89 gal |
| max working capacity | 2620 m ² /h-28201 ft ² /h | 2620 m ² /h-28201 ft ² /h |
| traction | mechanical | mechanical |
| max speed | 4 km/h-2,49 mile/h | 4 km/h-2,49 mile/h |
| motor type / power | 12V / 400W | Honda 5,5 HP / 3,4 kW |
| filtering surface | 2 m ² / 21,53 ft ² | 2 m ² / 21,53 ft ² |
| pressure on the brushes | adjustable | adjustable |
| filter shaker | electric | manual |
| dimension (cm)/weight | 126x63x85 / 78kg | 126x63x85 / 86kg |

PLUS



Large filter surface with electric filter shaker (ET model), manual filter shaker (ST model)



Side brush raising control. Main brush pressure regulation and quick main brush release



Heavy duty steel frame with 360° front wheel and long life elastic belts

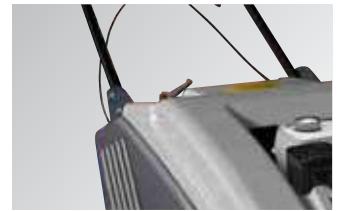

Control panel with: side brush raising control, suction switch off, flap raise system, battery level (ET model), on/ff key (ET model)

STANDARD EQUIPMENT

| | | | | |
|--|--|--|--|--|
|  <ul style="list-style-type: none"> • 00080-04127 PP SWL 700 ET • 00080-04130 PP-Mixed steel SWL 700 ST |  <ul style="list-style-type: none"> • 00080-04124 PP |  <ul style="list-style-type: none"> • 00070-00427 paper filter 14 µm | | |
|--|--|--|--|--|

OPTIONAL

| | | | | |
|---|---|---|--|---|
|  <ul style="list-style-type: none"> • 00039-01771 Side brush protection |  <ul style="list-style-type: none"> • 00070-00431 PE panel filter 5µm |  <ul style="list-style-type: none"> • 00070-00433 HEPA panel filter | <ul style="list-style-type: none"> • 10001-07818 Trolley for collector tank set | <ul style="list-style-type: none"> model ET: • 00055-00149 Tubular battery pb-acid - 12V 118Ah C5 |
| <ul style="list-style-type: none"> model ET: • 00055-00130 GEL Battery 12 MFP 105 - 12V 105Ah C5 | <ul style="list-style-type: none"> model ET: • 00056-00068 - 12V-13A 100-240V 50-60 Hz | | | |

SWL 900

POWERED by
HONDATM
Only model 900 ST



MORE INFO



SWL 900 ST

MORE INFO



SWL 900 ET

CHARACTERISTICS

• Ideal for medium and large surfaces • Large filter surface with electric filter shaker (ET model) • Manual filter shaker (ST model) • Side brush raising control • Suction switch off • Flap raise system • Panel filter in horizontal position • Main brush pressure regulation • Indirect back collection • Quick main brush release • Long life elastic belts • Reclining handle • Suction selection lever • Traction lever • Antistatic device • Wide collector tank • Heavy duty steel frame • Side brush mechanical engagement • Battery and battery charger not included.

TECHNICAL DATA

| | SWL 900 ET | SWL 900 ST |
|---------------------------------|--|--|
| code | 39002-00071 | 39002-00072 |
| main brush width | 710mm / 27,95 inc | 710mm / 27,95 inc |
| main brush + 1 side brush width | 880mm / 34,64 inc | 880mm / 34,64 inc |
| collector tank | 55 lt / 14,53 gal | 55 lt / 14,53 gal |
| max working capacity | 3700m ² /h-39826 ft ² /h | 3700m ² /h-39826 ft ² /h |
| traction | mechanical | mechanical |
| max speed | 4 km/h-2,49mile/h | 4 km/h-2,49mile/h |
| motor type / power | 12V / 400W | Honda 5,5 HP / 3,4 kW |
| filtering surface | 3,02 m ² / 32,50 ft ² | 3,02 m ² / 32,50 ft ² |
| pressure on the brushes | adjustable | adjustable |
| filter shaker | electric | manual |
| dimension (cm)/weight | 126x83x85 / 89 kg | 126x83x85 / 97 kg |

PLUS



Large filter surface with electric filter shaker (ET model), manual filter shaker (ST model)



Side brush raising control. Main brush pressure regulation and quick main brush release

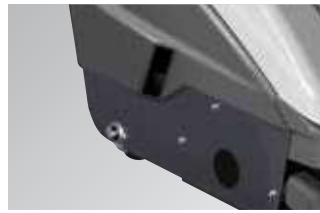

Heavy duty steel frame with 360° front wheel and long life elastic belts



Control panel with: side brush raising control, suction switch off, flap raise system, battery level (ET model), on/off key (ET model)

STANDARD EQUIPMENT

| | | | | |
|--|--|--|--|--|
|  <ul style="list-style-type: none"> • 00080-04128 PP SWL 900 ET • 00080-04131 PP-Mixed steel SWL 900 ST |  <ul style="list-style-type: none"> • 00080-04124 PP |  <ul style="list-style-type: none"> • 00070-00428 paper filter 14 µm | | |
|--|--|--|--|--|

OPTIONAL

| | | | | |
|---|---|---|--|---|
|  <ul style="list-style-type: none"> • 00039-01771 Side brush protection |  <ul style="list-style-type: none"> • 00070-00432 PE panel filter 5µm |  <ul style="list-style-type: none"> • 00070-00434 HEPA panel filter | <ul style="list-style-type: none"> • 10001-07818 Trolley for collector tank set | <ul style="list-style-type: none"> model ET: • 00055-00149 Tubular battery pb-acid - 12V 118Ah C5 |
| <ul style="list-style-type: none"> model ET: • 00055-00130 GEL Battery 12 MFP 105 - 12V 105Ah C5 | <ul style="list-style-type: none"> model ET: • 00056-00068 - 12V-13A 100-240V 50-60 Hz | | | |

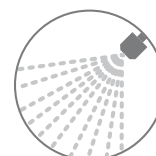
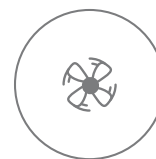
SWL R 950 ET

MORE INFO

**CHARACTERISTICS**

- Ideal for medium and large surfaces • Foot pedal brake • Parking brake • Brush electric control • Reverse lighting and acoustic warning • Water system for dust reduction with rear tank • Charge meter • Hour meter • Large filter surface with electric filter shaker • Horizontal cartridge filter • Main brush pressure adjustment • Rear indirect collection tank • Main brush quick release • Long life elastic belts • Heavy duty steel frame • Motorized side brushes • LED headlight • Battery and battery charger not included.

TECHNICAL DATA

| | SWL R 950 ET |
|---------------------------------|--|
| code | 39002-00067 |
| main brush width | 500mm / 16,4 inc |
| main brush + 1 side brush width | 750mm / 29,5 inc |
| main brush + 2 side brushes | 1050 mm / 41,3 inc |
| collector tank | 50 lt / 13,2 gal |
| max working capacity | 6000m ² /h-64583,3 ft ² /h |
| max speed/traction | 12 km/h-7,4mile/h / mechanical |
| motor type / power | 48V (4x12V)/800W |
| filtering surface | 1,5 m ² / 16,1 ft ² |
| pressure on the brushes | side 2x120 N/central 250 N |
| filter shaker | electric |
| dimension (cm)/weight | 80x135x110 /225 kg |

PLUS

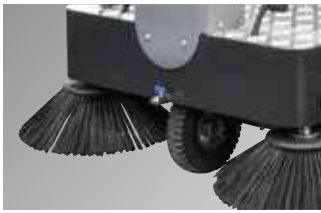

Front water system for dust reduction with 2lt rear tank



Front working LED light system



Heavy duty steel frame with main brush pressure adjustment and quick release



Reverse lighting and acoustic warning system

STANDARD EQUIPMENT

| | | | | |
|--|--|---|--|--|
|  <ul style="list-style-type: none"> • 00080-04153 PP brush |  <ul style="list-style-type: none"> • 00080-04152 2x PP side brush |  <ul style="list-style-type: none"> • 00070-00452 Cartridge filter 5 µm | | |
|--|--|---|--|--|

OPTIONAL

| | | | | |
|---|--|---|---|--|
|  <ul style="list-style-type: none"> • 00056-00071 Battery charger model 230V/50-60 Hz | <ul style="list-style-type: none"> • 4x 00055-00112 battery 12V 58 Ah C20 | <ul style="list-style-type: none"> • 36059-00085 battery charger model 110V/60Hz | <ul style="list-style-type: none"> • 00080-04755 1x mixed steel side brush | |
|---|--|---|---|--|

SWL R 990



POWERED by
HONDA[™]
 Only model 990 ST



MORE INFO



CHARACTERISTICS

- Ideal for medium surfaces • Large filter surface distributed on 6 cartridge filters fitted with electric filter shaker • Side brush raising control • **Complete right/left side brush** • Suction switch off • Main brush pressure regulation • Indirect back collection • Quick changing of the main brush and side brush • Long life elastic belts • Suction selection lever • Antistatic device • Battery level indicator (ET model) • Wide collector tank • Heavy duty steel frame • Perfectly balanced weight of the components, thus resulting in totally safe quick changes of direction • Battery and battery charger not included.

TECHNICAL DATA

| | SWL R 990 ET | SWL R 990 ST |
|-----------------------------|--|--|
| code | 39002-00064 | 39002-00065 |
| main brush width | 700mm / 27,5 inc | 700mm / 27,5 inc |
| main brush + 1 side brush | 920mm / 36,2 inc | 920mm / 36,2 inc |
| main brush + 2 side brushes | 1140 mm / 44,8 inc | 1140 mm / 44,8 inc |
| collector tank | 62 lt / 16,3 gal | 62 lt / 16,3 gal |
| max working capacity | 6200m ² /h-66736 ft ² /h | 7700m ² /h-82882 ft ² /h |
| traction/ limiting gradient | rear/12% | front/14% |
| max speed | 6,1 km/h-3,7mile/h | 7,6 km/h-4,7mile/h |
| motor type / power | 24V / 1150W | Honda 5,5 HP / 4,1 kW |
| filtering surface | 6 m ² / 64,5 ft ² | 6 m ² / 64,5 ft ² |
| filter shaker | electric | electric |
| dimension (cm)/weight | 143x91x114 / 256 kg | 143x91x114 / 288 kg |

PLUS



Complete right/left side brush with brush raising control system



Heavy duty steel frame and wide collector tank. Perfectly balanced weight of the components, thus resulting in totally safe quick changes of direction





Panel control with: suction switch off system, battery level indicator (ET model) and on/off key



Large filter surface distributed on 6 cartridge filters fitted with electric filter shaker

STANDARD EQUIPMENT

| | | | | |
|--|--|--|--|--|
|  <ul style="list-style-type: none"> • 00080-04142 PP SWL R 990 ET • 00080-04133 PP-Mixed steel SWL R 990 ST |  <ul style="list-style-type: none"> • 2 x 00080-04126 PP SWL R 990 ET • 2 x 00080-04136 PP-Mixed steel SWL R 990 ST |  <ul style="list-style-type: none"> • 6 x 00070-00430 paper filter 14 µm | | |
|--|--|--|--|--|

OPTIONAL

| | | | | |
|---|---|--|--|--|
| <ul style="list-style-type: none"> • 10001-07819 Anti-trace wheels | <ul style="list-style-type: none"> • 00070-00436 polyester filter • 00070-00437 Hepa filter | <ul style="list-style-type: none"> • 00054-01367 Steel collector tank | <ul style="list-style-type: none"> • 00039-01772 Right brush protection | <ul style="list-style-type: none"> • 00039-01769 Left brush protection |
| <ul style="list-style-type: none"> • 00072-00508 overhead guard | <ul style="list-style-type: none"> model ET: • 4 x 00055-00013 tubular battery pb-acid 6V180Ah C5 | <ul style="list-style-type: none"> model ET: • 4 x 00055-00142 GEL Battery 6 MFP 180-6V 180Ah C5 | <ul style="list-style-type: none"> model ET: • 4 x 00055-00120 Battery - 6V 250Ah C5 | <ul style="list-style-type: none"> model ET: • 00056-00067 Battery Charger 24V 30A 115-240/50-60 + Connection cable battery charger RB50-RB80: cod 10002-08044 + Connection cable battery charger RB80-RB175: cod 10002-07866 |

SWL R 1000



POWERED by
HONDA

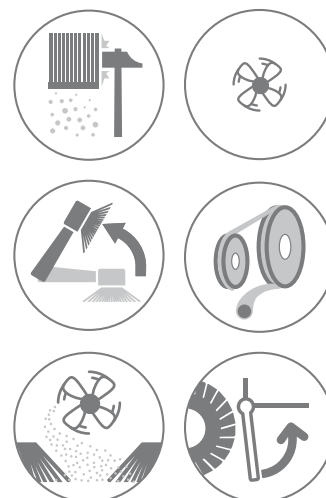

MORE INFO



CHARACTERISTICS

• Ideal for large surfaces • Large filter surface distributed on 6 cartridge filters fitted with electric filter shaker • Side brush raising control • **Complete right/left side brush** • Suction switch off • Flashing light • Main brush pressure regulation • Indirect back collection • Front dust vacuum system • Quick changing of the main brush and side brush without tools • Long life elastic belts • Suction selection lever • Antistatic device • Battery level indicator (ET model) • Wide collector tank • Heavy duty steel frame • Adjustable seat • Perfectly balanced weight of the components, thus resulting in totally safe quick changes of direction • Battery and battery charger not included. • Front light system (**optional on request**), standard for models code 39002-00030/39002-00039

TECHNICAL DATA

| | SWL R 1000 ET | SWL R 1000 ST | SWL R 1000 ET Light | SWL R 1000 ST Light |
|------------------------------|---|---|---|---|
| code | 39002-00074 | 39002-00075 | 39002-00030 | 39002-00039 |
| main brush width | 700 mm / 27,56 inc | 700 mm / 27,56 inc | 700 mm / 27,56 inc | 700 mm / 27,56 inc |
| main brush + 1 side brush | 920 mm / 36,22 inc | 920 mm / 36,22 inc | 920 mm / 36,22 inc | 920 mm / 36,22 inc |
| main brush + 2 side brushes | 1150 mm / 45,28 inc | 1150 mm / 45,28 inc | 1150 mm / 45,28 inc | 1150 mm / 45,28 inc |
| collector tank | 62 lt / 16,3 gal | 62 lt / 16,3 gal | 62 lt / 16,3 gal | 62 lt / 16,3 gal |
| max working capacity | 6200 m ² /h-66736 ft ² /h | 7700 m ² /h-82881 ft ² /h | 6200 m ² /h-66736 ft ² /h | 7700 m ² /h-82881 ft ² /h |
| traction / limiting gradient | rear wheels / 10% | front wheel / 17% | rear wheels / 10% | front wheel / 17% |
| max speed | 5,8 km/h-3,60 mile/h | 7,2 km/h-4,5 mile/h | 5,8 km/h-3,60 mile/h | 7,2 km/h-4,5 mile/h |
| motor type / power | 24V / 1150W | Honda 5,5 HP / 4,1kW | 24V / 1150W | Honda 5,5 HP / 4,1kW |
| filtering surface | 6 m ² / 64,6 ft ² | 6 m ² / 64,6 ft ² | 6 m ² / 64,6 ft ² | 6 m ² / 64,6 ft ² |
| filter shaker | electric | electric | electric | electric |
| dimension (cm)/weight | 143x91x114/260kg | 143x91x114/300kg | 143x91x114/260kg | 143x91x114/300kg |

PLUS



Complete right/left side brush with brush raising control system



Heavy duty steel frame and wide collector tank. Perfectly balanced weight of the components, thus resulting in totally safe quick changes of direction



Panel control with: suction switch off system, battery level indicator (ET model) and on/off key. Flashing light



Large filter surface distributed on 6 cartridge filters fitted with electric filter shaker

Available models with limiting gradient 20%

- SWL R 1000 ET cod. 39002-00049 • SWL R 1000 ET Light cod. 39002-00050
- SWL R 1000 ST cod. 39002-00051 • SWL R 1000 ST Light cod. 39002-00052

STANDARD EQUIPMENT

| | | | | |
|--|--|--|--|--|
|  <ul style="list-style-type: none"> • 00080-04142 PP SWL R 1000 ET • 00080-04133 PP-Mixed steel SWL R 1000 ST |  <ul style="list-style-type: none"> • 2 x 00080-04126 PP SWL R 1000 ET • 2 x 00080-04136 PP-Mixed steel SWL R 1000 ST |  <ul style="list-style-type: none"> • 6 x 00070-00430 paper filter 14 µm | | |
|--|--|--|--|--|

OPTIONAL

| | | | | |
|---|---|--|--|--|
| <ul style="list-style-type: none"> • 10001-07819 Anti-trace wheels | <ul style="list-style-type: none"> • 00070-00436 polyester filter • 00070-00437 Hepa filter | <ul style="list-style-type: none"> • 00054-01367 Steel collector tank | <ul style="list-style-type: none"> • 00039-01772 Right brush protection | <ul style="list-style-type: none"> • 00039-01769 Left brush protection |
| <ul style="list-style-type: none"> • 00072-00509 overhead guard | <ul style="list-style-type: none"> model ET: • 4 x 00055-00013 tubular battery pb-acid 6V180Ah C5 | <ul style="list-style-type: none"> model ET: • 4 x 00055-00142 GEL Battery 6 MFP 180-6V 180Ah C5 | <ul style="list-style-type: none"> model ET: • 4 x 00055-00107 Battery - 6V 250Ah C5 | <ul style="list-style-type: none"> model ET: • 00056-00067 Battery Charger 24V 30A 115-240/50-60 + Connection cable battery charger RB50-RB80: cod 10002-08044 + Connection cable battery charger RB80-RB175: cod 10002-07866 |

SWL R 1100



POWERED by
HONDA



MORE INFO



CHARACTERISTICS

- Large filter surface distributed on 8 cartridge filters fitted with electric filter shaker.
- Side brush raising control.
- On request DSA unload device for tank emptying into dust containers up to 145 cm height.
- **Complete right/left side brush.**
- Suction switch off.
- Flashing light.
- Main brush pressure regulation.
- Service and parking brake.
- Hour meter and klaxon.
- Front dust vacuum system.
- Quick changing of the main brush and side brush without tools.
- Long life elastic belts.
- Suction selection lever.
- Antistatic device.
- Battery level indicator (mod.ET).
- 115 lt wide collector tank.
- Heavy duty steel frame.
- Adjustable seat.
- Battery and battery charger not included.
- 24V - 1200W AC three-phase traction motor
- **Front working light system.**

TECHNICAL DATA

| | SWL R 1100 ET | SWL R 1100 DT | SWL R 1100 ST |
|------------------------------|--|--|--|
| code | 39002-00036 | 39002-00033 | 39002-00044 |
| main brush width | 800mm / 31,50 inc | 800mm / 31,50 inc | 800mm / 31,50 inc |
| main brush + 1 side brush | 1050mm / 41,34 inc | 1050mm / 41,34 inc | 1050mm / 41,34 inc |
| main brush + 2 side brushes | 1300mm / 51,19 inc | 1300mm / 51,19 inc | 1300mm / 51,19 inc |
| collector tank | 115 lt / 30,3 gal | 115 lt / 30,3 gal | 115 lt / 30,3 gal |
| max working capacity | 9700 m ² /h-104409 ft ² /h | 9700 m ² /h-104409 ft ² /h | 9700 m ² /h-104409 ft ² /h |
| traction / limiting gradient | front wheels / 20% | front wheel / 10% | front wheel / 10% |
| max speed | 7,5 km/h-4,66 mile/h | 7,5 km/h-4,66 mile/h | 7,5 km/h-4,66 mile/h |
| motor type / power | 24V/2,67 kW | Diesel Yanmar 6,7 Hp/4,92 kW | Honda 6,5 Hp/4,88 kW |
| filtering surface | 6,4 m ² / 68,89 ft ² | 6,4 m ² / 68,89 ft ² | 6,4 m ² / 68,89 ft ² |
| filter shaker | electric | electric | electric |
| dimension (cm)/weight | 160x101x130/375 kg | 160x101x130/434 kg | 160x101x130/434 kg |

PLUS



Complete right/left side brush with brush raising control system



Heavy duty steel frame and wide collector tank. Perfectly balanced weight of the components, thus resulting in totally safe quick changes of direction



Panel control with: suction switch off system, battery level indicator (ET model), on/off key, hour meter and horn. Flashing light and front working light system



Large filter surface distributed on 8 cartridge filters fitted with electric filter shaker

Available models with limiting gradient 20%

- SWL R 1100 DT cod. 39002-00056
- SWL R 1100 ST cod. 39002-00058

On request model with overhead guard

STANDARD EQUIPMENT

| | | | | |
|--|--|--|--|--|
|  <ul style="list-style-type: none"> • 00080-04137 PP SWL R 1100 ET • 00080-04139 PP-Mixed steel SWL R 1100 DT/ST/GT |  <ul style="list-style-type: none"> • 2 x 00080-04138 PP SWL R 1100 ET • 2 x 00080-04140 PP-Mixed steel SWL R 1100 DT/ST/GT |  <ul style="list-style-type: none"> • 8 x 00070-00435 paper filter 20 µm | | |
|--|--|--|--|--|

OPTIONAL

| | | | | |
|--|---|---|--|--|
| <ul style="list-style-type: none"> • 00070-00435 polyester filter | <ul style="list-style-type: none"> • 00070-00438 Hepa filter | <p>model ET:</p> <ul style="list-style-type: none"> • 4 x 00055-00157 tubular battery pb-acid - 6V 320 Ah C5 <ul style="list-style-type: none"> • 1x 10002-07866 • 1x 10002-08044 | <p>model ET:</p> <ul style="list-style-type: none"> • 00056-00069 - battery charger 24V-60A 230V 50-60 Hz | |
|--|---|---|--|--|

SWL R 1100 Bin-Up



POWERED by
HONDA

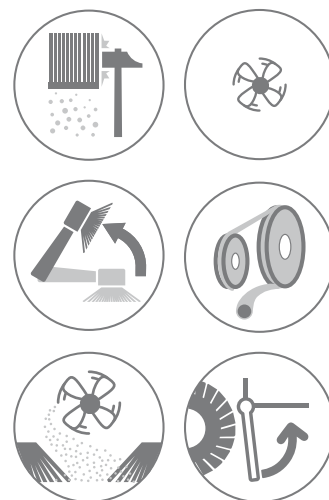

MORE INFO



CHARACTERISTICS

- Large filter surface distributed on 8 cartridge filters fitted with electric filter shaker. • Side brush raising control. • **Complete right/left side brush.** • Anti-trace wheels (mod.ET). • 2 m steering angle and lift flap pedal. • Main brush pressure regulation. • Service and parking brake. • Hour meter and klaxon and flashing light. • Indirect back collection. • Front dust vacuum system. • Quick changing of the main brush and side brush without tools. • Long life elastic belts. • Suction selection lever. • Antistatic device. • Battery level indicator (mod.ET). • 115 lt wide collector tank. • Dumping height, hydraulic lift 1450 mm • Heavy duty steel frame. • Adjustable seat. • Battery and battery charger not included. • 24V - 1200W AC three-phase traction motor • **Front working light system.**

TECHNICAL DATA

| | SWL R 1100 ET BIN-UP | SWL R 1100 DT BIN-UP | SWL R 1100 ST BIN-UP |
|------------------------------|--|--|--|
| code | 39002-00043 | 39002-00041 | 39002-00045 |
| main brush width | 800mm / 31,50 inc | 800mm / 31,50 inc | 800mm / 31,50 inc |
| main brush + 1 side brush | 1050mm / 41,34 inc | 1050mm / 41,34 inc | 1050mm / 41,34 inc |
| main brush + 2 side brushes | 1300mm / 51,19 inc | 1300mm / 51,19 inc | 1300mm / 51,19 inc |
| collector tank | 115 lt / 30,3 gal | 115 lt / 30,3 gal | 115 lt / 30,3 gal |
| max working capacity | 9700 m ² /h-104409 ft ² /h | 9700 m ² /h-104409 ft ² /h | 9700 m ² /h-104409 ft ² /h |
| traction / limiting gradient | front wheels / 20% | front wheel / 10% | front wheel / 10% |
| max speed | 7,5 km/h-4,66 mile/h | 7,5 km/h-4,66 mile/h | 7,5 km/h-4,66 mile/h |
| motor type / power | 24V/3,47 kW | Diesel Yanmar 6,7 Hp/4,92 kW | Honda 6,5 Hp/4,88 kW |
| filtering surface | 6,4 m ² / 68,89 ft ² | 6,4 m ² / 68,89 ft ² | 6,4 m ² / 68,89 ft ² |
| filter shaker | electric | electric | electric |
| dimension (cm)/weight | 160x101x130/448 kg | 160x101x130/454 kg | 160x101x130/434 kg |

PLUS



Complete right/left side brush with brush raising control system



Heavy duty steel frame and wide collector tank. Perfectly balanced weight of the components, thus resulting in totally safe quick changes of direction



Panel control with: suction switch off system, battery level indicator (ET model), on/off key, hour meter and horn. Flashing light and front working light system



DSA system: unload device for tank emptying into dust containers up to 145 cm height.

Available models with limiting gradient 20%

- SWL R 1100 DT BIN-UP cod. 39002-00057
- SWL R 1100 ST BIN-UP cod. 39002-00059

On request model with overhead guard

STANDARD EQUIPMENT

| | | | | |
|--|--|--|--|--|
|  <ul style="list-style-type: none"> • 00080-04137 PP SWL R 1100 ET • 00080-04139 PP-Mixed steel SWL R 1100 DT/ST/GT |  <ul style="list-style-type: none"> • 2 x 00080-04138 PP SWL R 1100 ET • 2 x 00080-04140 PP-Mixed steel SWL R 1100 DT/ST/GT |  <ul style="list-style-type: none"> • 8 x 00070-00435 paper filter 20 µm | | |
|--|--|--|--|--|

OPTIONAL

| | | | | |
|--|---|---|--|--|
| <ul style="list-style-type: none"> • 00070-00435 polyester filter | <ul style="list-style-type: none"> • 00070-00438 Hepa filter | <p>model ET:</p> <ul style="list-style-type: none"> • 4 x 00055-00157 tubular battery pb-acid - 6V 320 Ah C5 <ul style="list-style-type: none"> • 1x 10002-07866 • 1x 10002-08044 | <p>model ET:</p> <ul style="list-style-type: none"> • 00056-00069 - battery charger 24V-60A 230V 50-60 Hz | |
|--|---|---|--|--|

SWL R 1200 Bin-Up

NEW



MORE INFO



CHARACTERISTICS

- Hydraulic traction on the front wheel (DT model) • Electronic traction on the 2 rear wheels (ET model) • Suction filter with 11 m² bags of filtering surface
- Double electric filter vibrator (DT model) • Electric filter vibrator (ET model) • 2 Intake fans • Hydraulic service brake (DT model) • Service brake and drum parking on the rear wheels (ET model) • Drum parking brake (DT model) • Maximum surmountable slope: 18% (DT model) • Maximum climbable slope: 20% (ET model) • Intake closure • Front fender wheels • Strobe flash on bonnet • Right and left side brush Ø 500 mm with speed regulator (DT model), with independent motors (ET model) • Electric controls side brush (DT model) • Central brush 880 mm x Ø 350 mm in ppl/steel (DT model), ppl only (ET model) • Flap pedal • Super elastic rubber wheels Ø 330 • Hydraulic drainage height collection drawer: From 400 to 1430 mm • Actual collection drawer capacity: 180 l • Hour meter and horn • Fuel reserve indicator light (DT model) • Front working lights system

TECHNICAL DATA

| | SWL R 1200 ET BIN-UP | SWL R 1200 DT BIN-UP |
|------------------------------|-------------------------|-----------------------------|
| code | 39002-00113 | 39002-00114 |
| main brush width | 900 mm | 900 mm |
| main brush + 1 side brush | 1150 mm | 1150 mm |
| main brush + 2 side brushes | 1440 mm | 1440 mm |
| collector tank | 180 lt | 180 lt |
| max working capacity | 11500 m ² /h | 11500 m ² /h |
| traction / limiting gradient | rear electronics/20% | front hydraulic system/18% |
| max speed | 2.20 m/s | 2.20 m/s |
| motor type / power | 24V/2.98 W | Kubota Z 602/16.8 Hp Diesel |
| filtering surface | 11 m ² | 11 m ² |
| filter shaker | electric | electric |
| dimension (cm)/weight | 190x130x153/750 kg | 190x130x153/870 kg |

PLUS



Right and left side brush Ø 500 mm with speed regulator (DT model), with independent motors (ET model). Electric controls side brush (DT model). Hydraulic traction on the front wheel (DT model). Electronic traction on the 2 rear wheels (ET model).



Heavy duty steel frame and wide collector tank. Actual collection drawer capacity 180 litres.



Suction filter with 11 mq bags of filtering surface. Double electric filter vibrator (DT model). Electric filter vibrator (ET model)



DSA system: hydraulic drainage height collection drawer, from 400 to 143 cm

STANDARD EQUIPMENT

| | | | | |
|---|---|--|--|--|
|  <ul style="list-style-type: none"> • 00080-05107 PP Brush SWL R 1200 ET • 00080-05108 Mixed steel brush SWL R 1200 DT |  <ul style="list-style-type: none"> • 2 x 00080-05109 PP Side Brush SWL R 1200 ET • 2 x 00080-05110 Side brush mixed steel SWL R 1200 DT |  <ul style="list-style-type: none"> • 00070-00756 class M bag filter | | |
|---|---|--|--|--|

OPTIONAL

| | | | | |
|--|---|---|--|--|
|  <ul style="list-style-type: none"> • 00070-00757 Scalar bags filter w/T452novates class M separator • 00070-00758 Scalar bags filter w/class M bia separator | <p>model ET:</p> <ul style="list-style-type: none"> • 4 x 00055-00157 tubular battery pb-acid - 6V 320 Ah C5 + 3 x 10002-07046 cad. + 1x 10002-08086 | <p>model ET:</p> <ul style="list-style-type: none"> • 00055-00164 Battery 24V 400Ah Pb | <p>model ET:</p> <ul style="list-style-type: none"> • 00056-00069 - battery charger 24V-60A 230V 50-60 Hz | |
|--|---|---|--|--|

SWL R 1300 DT Bin-Up

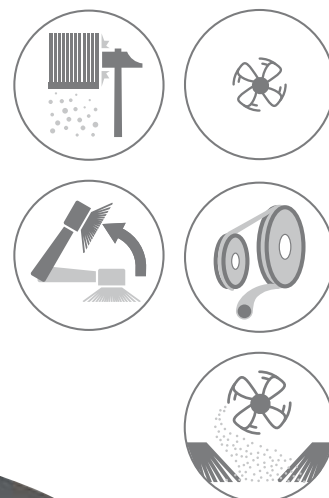

MORE INFO



CHARACTERISTICS

- Compact, handy, sturdy and resistant, easy to use
- High performance in terms of (m²/h), both in terms of cleaning and dust control
- Large tank size, brushes, motor power
- Cleaning of large surfaces starting from 19.000 m²/h
- Central brushes
- Right side floating brush
- Dust control through filtering system
- Polyester bag filter
- Electric filter shaker
- Closed circuit hydraulic drive
- Steering with power steering on the rear wheel
- Waste discharge directly in the designated areas
- Traction control with electric motor or alternating current A/C 48V
- Optional: green water-repellent filter (guarantees high filtration up to 1 micron)

TECHNICAL DATA

| | SWL R 1300 DT BIN-UP 1 brush | SWL R 1300 DT BIN-UP 2 brushes |
|------------------------------|---|---|
| code | 39002-00066 | 39002-00128 |
| main brush width | 1000mm / 40 inc | 1000mm / 40 inc |
| main brush + 1 side brush | 1485mm / 58,4 inc | 1485mm / 58,4 inc |
| main brush + 2 side brushes | - | 1615mm / 63,5 inc |
| collector tank | 490 lt / 129,4 gal | 490 lt / 129,4 gal |
| max working capacity | 19200 m ² /h-206667 ft ² /h | 19200 m ² /h-206667 ft ² /h |
| traction / limiting gradient | Hydrostatic / 18% | Hydrostatic / 18% |
| max speed | 12 km/h-7,4 mile/h | 12 km/h-7,4 mile/h |
| motor type / power | Kubota/diesel | Kubota/diesel |
| filtering surface | 8 m ² / 86,1 ft ² | 8 m ² / 86,1 ft ² |
| filter shaker | electric | electric |
| dimension (cm)/weight | 225x145x154/950 kg | 225x145x154/950 kg |

PLUS

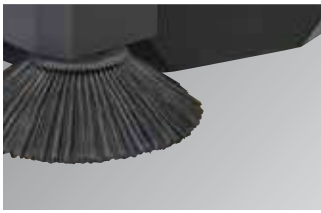

Compact, handy, sturdy and resistant, easy to use. Large tank size, brushes, motor power. Right side floating brush



Large central brushes size



Polyester bag filter with electric filter shaker. Dust control through filtering system



Steering with power steering on the rear wheel

STANDARD EQUIPMENT

| | | | | |
|--|--|---|--|--|
|  <ul style="list-style-type: none"> • 00080-05193 Main mixed steel brush |  <ul style="list-style-type: none"> • 00080-05192 Mixed steel side brush |  <ul style="list-style-type: none"> • 00070-00781 Pocket filter | | |
|--|--|---|--|--|

SWL R 1300 DT Bin-Up with overhead guard

NEW

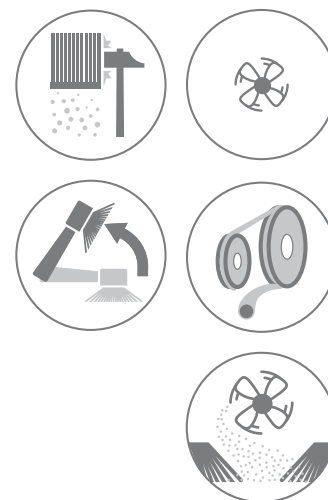

MORE INFO



CHARACTERISTICS

- Compact, handy, sturdy and resistant, easy to use
- High performance in terms of (m²/h), both in terms of cleaning and dust control
- Large tank size, brushes, motor power
- Cleaning of large surfaces starting from 19.000 m²/h
- Central brushes
- Right side floating brush
- Dust control through filtering system
- Polyester bag filter
- Electric filter shaker
- Closed circuit hydraulic drive
- Steering with power steering on the rear wheel
- Waste discharge directly in the designated areas
- Traction control with electric motor or alternating current A/C 48V
- Roll-bar open cabin
- Overhead guard
- Optional: green water-repellent filter (guarantees high filtration up to 1 micron)

TECHNICAL DATA

| | SWL R 1300 DT BIN-UP 1 brush | SWL R 1300 DT BIN-UP 2 brushes |
|------------------------------|---|---|
| code | 39002-00105 | on request |
| main brush width | 1000mm / 40 inc | 1000mm / 40 inc |
| main brush + 1 side brush | 1485mm / 58,4 inc | 1485mm / 58,4 inc |
| main brush + 2 side brushes | - | 1615mm / 63,5 inc |
| collector tank | 490 lt / 129,4 gal | 490 lt / 129,4 gal |
| max working capacity | 19200 m ² /h-206667 ft ² /h | 19200 m ² /h-206667 ft ² /h |
| traction / limiting gradient | Hydrostatic / 18% | Hydrostatic / 18% |
| max speed | 12 km/h-7,4 mile/h | 12 km/h-7,4 mile/h |
| motor type / power | Kubota/diesel | Kubota/diesel |
| filtering surface | 8 m ² / 86,1 ft ² | 8 m ² / 86,1 ft ² |
| filter shaker | electric | electric |
| dimension (cm)/weight | 225x145x154/950 kg | 225x145x154/950 kg |

PLUS



Compact, handy, sturdy and resistant, easy to use. Large tank size, brushes, motor power. Right side floating brush



Heavy duty overhead guard



Polyester bag filter with electric filter shaker. Dust control through filtering system



Large central brushes size. Steering with power steering on the rear wheel

STANDARD EQUIPMENT

| | | | | |
|--|--|---|--|--|
|  <ul style="list-style-type: none"> • 00080-05193 Main mixed steel brush |  <ul style="list-style-type: none"> • 00080-05192 Mixed steel side brush |  <ul style="list-style-type: none"> • 00070-00781 Pocket filter | | |
|--|--|---|--|--|

SWL R 1300 DT Bin-Up with glass cabin

NEW

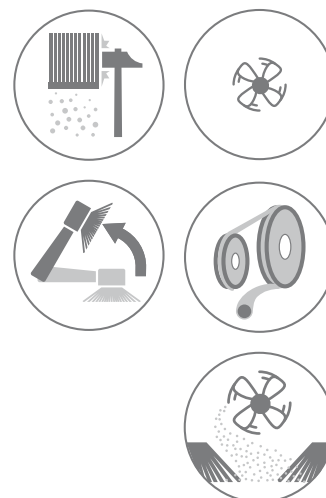

MORE INFO



CHARACTERISTICS

- Compact, handy, sturdy and resistant, easy to use
- High performance in terms of (m²/h), both in terms of cleaning and dust control
- Large tank size, brushes, motor power
- Cleaning of large surfaces starting from 19.000 m²/h
- Central brushes
- Right side floating brush
- Dust control through filtering system
- Polyester bag filter
- Electric filter shaker
- Closed circuit hydraulic drive
- Steering with power steering on the rear wheel
- Waste discharge directly in the designated areas
- Traction control with electric motor or alternating current A/C 48V (cod. 39002-00106)
- Glass cabin with air conditioner system cod.39002-00111
- Optional: green water-repellent filter (guarantees high filtration up to 1 micron)

TECHNICAL DATA

| | SWL R 1300 DT BIN-UP 1 brush | SWL R 1300 DT AC BIN-UP 1 brush | SWL R 1300 DT BIN-UP 2 brushes | SWL R 1300 DT AC BIN-UP 2 brush |
|------------------------------|---|---|---|---|
| code | 39002-00106 | 39002-00111 | on request | on request |
| main brush width | 1000mm / 40 inc | 1000mm / 40 inc | 1000mm / 40 inc | 1000mm / 40 inc |
| main brush + 1 side brush | 1485mm / 58,4 inc | 1485mm / 58,4 inc | 1485mm / 58,4 inc | 1485mm / 58,4 inc |
| main brush + 2 side brushes | - | - | 1615mm / 63,5 inc | 1615mm / 63,5 inc |
| collector tank | 490 lt / 129,4 gal | 490 lt / 129,4 gal | 490 lt / 129,4 gal | 490 lt / 129,4 gal |
| max working capacity | 19200 m ² /h-206667 ft ² /h | 19200 m ² /h-206667 ft ² /h | 19200 m ² /h-206667 ft ² /h | 19200 m ² /h-206667 ft ² /h |
| traction / limiting gradient | Hydrostatic / 18% | Hydrostatic / 18% | Hydrostatic / 18% | Hydrostatic / 18% |
| max speed | 12 km/h-7,4 mile/h | 12 km/h-7,4 mile/h | 12 km/h-7,4 mile/h | 12 km/h-7,4 mile/h |
| motor type / power | Kubota/diesel | Kubota/diesel | Kubota/diesel | Kubota/diesel |
| filtering surface | 8 m ² / 86,1 ft ² | 8 m ² / 86,1 ft ² | 8 m ² / 86,1 ft ² | 8 m ² / 86,1 ft ² |
| filter shaker | electric | electric | electric | electric |
| dimension (cm)/weight | 225x145x154/950 kg | 225x145x154/950 kg | 225x145x154/950 kg | 225x145x154/950 kg |

PLUS

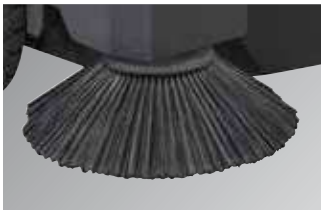

Compact, handy, sturdy and resistant, easy to use. Large tank size, brushes, motor power. Right side floating brush



Heavy duty glass cabin (code 39002-00106). Heavy duty glass cabin with air conditioner system (code 39002-00111)





Polyester bag filter with electric filter shaker. Dust control through filtering system



Large central brushes size. Steering with power steering on the rear wheel

STANDARD EQUIPMENT

| | | | | |
|--|--|---|--|--|
|  <ul style="list-style-type: none"> • 00080-05193 Main mixed steel brush |  <ul style="list-style-type: none"> • 00080-05192 Mixed steel side brush |  <ul style="list-style-type: none"> • 00070-00781 Pocket filter | | |
|--|--|---|--|--|



FMS

Fleet Management System

Lavor's **Fleet Management System** allows having your entire fleet of floor scrubbers and sweepers in a cloud on the Web or mobile. **FMS** shows the current status of your fleet by providing all useful, real-time data on the operator's driving status and machines' condition. A simple and intuitive dashboard shows all the information needed to measure machine efficiency and productivity:

Battery monitoring

You can view the progress of battery charging and discharging. In models equipped with a current sensor, the AH delivered power consumption can be displayed.



Work area: management of business areas

You can know the location, status and activities of the machines in real time while setting the work areas. The configuration of areas is totally customizable; in fact, a work area of any shape and size can be drawn on the map, outside of which the machine may reduce its functions.



Mobile app for real-time monitoring

A service (for consultation purposes only, for now) allows users to display the portal homepage, machine section, alarm section and map section. In addition, the **Fleet Management System** comes along with a primary appraisal that will certify the system for the purchaser, detailing the system itself.



THE TECHNOLOGIES INCLUDED OFFER MULTIPLE BENEFITS

- Increased productivity through shorter set-up times, reduced errors and downtime
- Improved quality of operation and maintenance
- Increased product competitiveness due to IOT-derived advanced features.

SWEEPERS FMS RANGE

| | |
|-------------|---------------------------|
| 39002-00091 | SWL R950 ET - FMS |
| 39002-00092 | SWL R990 ET - FMS |
| 39002-00088 | SWL R1100 ET BIN-UP - FMS |
| 39002-00090 | SWL R1300 DT - FMS |



GV series is suitable to degrease and sanitize any object or surface in an easy, ecological and definitive way.

GV range is made up of electric generators, vacuum steam generators, vacuum steam generators with foam system.

Ideal for food and baking industry, for private and institutional use, for pharmaceutical and mechanical industry, for dairy factories, for building sectors and so on.

Performances: temperature, steam production and pressure

The same remarks about pressure and delivery rate made for high-pressure cleaners, have to be taken into consideration also for steam generators; in this case, the important difference is the physical relationship (and so not subjective or debatable) that exists between steam pressure and its temperature: to a fixed pressure values correspond right and univocal temperature.

Knowing these values it is easy to identify the ones (like us) who show the right double relation between pressure and temperature. Outlet steam temperature (not boiler temperature, that is higher) is important because there are natural limits (about 140°C) under which it is not possible to talk about sanitification and so the purpose that led to the machine purchase (clearly wrong) could be unattended.

Is it better a steam generator or a hot water high-pressure cleaner?

As far as the choice is concerned, the aspects to be considered are the analysis of the task that must be done and all the elements that make up the cost of the operation, i.e. working speed (labour cost) and (more and more important) waste treatment (waste disposal cost).

As far as the working speed is considered, it is important the whole cleaning procedure and not only the effective washing time: with the high-pressure cleaner it is not possible an indoor washing, unless there is a filled in collection system, instead it is necessary to move the washing phase outside; with the steam generator it is not necessary to move outside, it is possible to wash the part exactly where it is, because the water generated can be easily dried.

Steam at 180°C allow to degrease dirt also without the use of heavy chemical products. If they are necessary to speed up the washing task, it is very important to consider the cost of draining away dirty water. The danger of chemical products used is generally proportional to the effectiveness against



increasing dirt tenacity.

If we wash with the high-pressure cleaner we produce from 10 to 21 litres of polluted water, that must be collected and drained following the current regulation: in a single wash of a couple of hours 2,5 tons of dirty water is produced!

If we wash with a steam generator, the most powerful machine produces 37 litres per hour, with the most part of the liquid that evaporates, with a two hour wash the remaining dampness and disinfecting product is very low!

Analyzing all these subjects it is clear that in particular circumstances (lack of purification plant for water treatment), the steam generator is more advantageous of a high-pressure cleaner. On the other side, rinsing speed is the consequence to the delivery rate that hits dirt, so if only the washing phase is considered, high-pressure cleaner is faster.

Steam can be considered water with a related dampness very, very low (superheated steam is just hot air and it doesn't have a significant mechanical action...), with an outlet temperature much higher (180°C) than a high-pressure cleaner: this means that the mechanical power is lower than the one of water, but the degreasing power of steam is much higher.

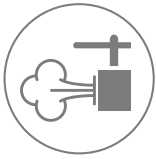

- **Discharge valve**

Allows a complete discharge of the boiler (not possible even through gun use). In this way it is possible to remove water and limestone residual inside the boiler and from the coil surface. This valve maybe opened only when the boiler is not hot, and it is recommended to accomplish regularly.



- **Unlimited autonomy**

The boiler is refilled by a water pump that gets water from an external water tank. This system allows an unlimited autonomy, because it is not necessary to turn off the steam generator and wait a lower temperature to refill with water. An automatic control recharges the boiler when necessary. In some models there is an acoustic signal advising about low water level inside the water tank.



- **Integrated vacuum**

Dirt is vacuumed inside a tank integrated in the machine



- **Multipurpose washable filter**

It combines all the advantages of the cartridge filter but with the plus that it can vacuum both dry and wet at the same time. It can be washed with tap water.

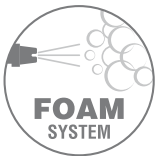

- **Foam system**

the machine is equipped with connection for compressed air and pressure gauge for foam cleaning. Using the lance with the hose a thick foam can be produced that will stay on the dirty components, giving more effectiveness to the detergent.



- **Temperature regulator**

It is possible to adjust the hot water outlet temperature. In this way, different temperatures can be selected depending on the dirt to be removed.



- **Integrated battery charger**

Some models are equipped with integrated battery charger, other ones have the predisposition only. It is possible to charge batteries in different rooms, without coming back to the same place.



- **Integrated battery**

Standard integrated battery is built with a maintenance free technology and it does not require restrictions about the place for battery charging. The non stop research allow to use always up-to-date batteries that combined with appropriate battery charger grant machine top performances.

Technical information

| Code | Model | Page | Absorbed power | Suction motor | Max. pressure | Steam production | Max. temperature | Heating and activation time required | Water tank capacity | Detergent tank capacity | Packaging dimensions | Packaging weight | Packaging weight | Pieces for pallet |
|-------------|----------------------|------|----------------|---------------|---------------|------------------|------------------|--------------------------------------|---------------------|-------------------------|----------------------|------------------|------------------|-------------------|
| | | | W | W | bar | Kg/h | °C | min | l | l | mm L x l x h | kg | lbs | n° |
| 45001-00005 | GV KONE | 316 | 2300 | - | 4 | 2,6 | 143 | 10 | 1,6 | - | 470x330x350 | 8 | 17,64 | 25 |
| 45002-00003 | GV Egon VAC 4.1 Plus | 318 | 1900 | 1200 | 5 | 2,3 | 152 | 2 | 1,2 | - | 550x400x500 | 14 | 30,86 | 12 |
| 45004-00033 | GV ETNA-R 5.1 | 320 | 3000 | 1100 | 7 | 3,25 | 165 | 4 | 5 | 5 | 750x600x1030 | 42,5 | 93,69 | 4 |
| 45004-00037 | GV ETNA-R 5.1 FR | 320 | 3000 | 1100 | 7 | 3,25 | 165 | 4 | 5 | 5 | 750x600x1030 | 42,5 | 93,69 | 4 |
| 45004-00036 | GV ETNA-R 5.1 FOAM | 322 | 3000 | 1100 | 7 | 3,25 | 165 | 4 | 5 | 5 | 750x600x1030 | 42,5 | 93,69 | 4 |
| 45006-00001 | GV KATLA | 324 | 3300 | - | 9 | 4,62 | 175 | 7 | 5 | 5 | 750x600x700 | 31 | 91,27 | 4 |
| 45003-00038 | GV 3 M PLUS | 326 | 3000 | - | 9 | 4,2 | 175 | 8 | 5 | 5 | 595x435x650 | 37 | 81,57 | 8 |
| 45003-00010 | GV 3.3 M PLUS | 326 | 3300 | - | 9 | 4,62 | 175 | 7 | 5 | 5 | 595x435x650 | 37 | 81,57 | 8 |
| 45010-00006 | GV 5 T PLUS | 328 | 5000 | - | 9 | 8 | 175 | 7 | 10 | 5 | 595x435x650 | 40 | 88,18 | 8 |
| 45010-00001 | GV 8 T PLUS | 328 | 8000 | - | 9 | 13,50 | 175 | 6 | 10 | 5 | 595x435x650 | 40 | 88,18 | 8 |
| 45012-00003 | GV 3.0 VAC | 330 | 3000 | 1100 | 8 | 4,2 | 170 | - | 5 | 5 | 460x820x940 | - | - | - |



| Code | Model | Page | Absorbed power | Suction motor | Max pressure | Steam production | Max temperature | Heating and activation time required | Water tank capacity | Detergent tank capacity | Packaging dimensions | Packaging weight | Packaging weight | Pieces for pallet |
|-------------|---------------------|------|----------------|---------------|--------------|------------------|-----------------|--------------------------------------|---------------------|-------------------------|----------------------|------------------|------------------|-------------------|
| | | | W | W | bar | Kg/h | °C | min | l | l | mm L x l x h | kg | lbs | n° |
| 45005-00010 | GV VESUVIO 10 | 332 | 10000 | - | 10 | 14,8 | 180 | 9 | 25 | 5 | 1300x780x1080 | 134 | 295,41 | 1 |
| 45005-00029 | GV VESUVIO 15 | 332 | 30000 | - | 10 | 22,2 | 180 | 8 | 25 | 5 | 1300x780x1080 | 134 | 295,41 | 1 |
| 45005-00002 | GV VESUVIO 18 | 332 | 18000 | - | 10 | 26,50 | 180 | 7 | 25 | 5 | 1300x780x1080 | 134 | 295,41 | 1 |
| 45005-00030 | GV VESUVIO 21 | 332 | 21000 | - | 10 | 31 | 180 | 7 | 25 | 5 | 1300x780x1080 | 134 | 295,41 | 1 |
| 45005-00001 | GV VESUVIO 30 | 332 | 30000 | - | 10 | 44,50 | 180 | 6 | 25 | 5 | 1300x780x1080 | 134 | 295,41 | 1 |
| 45009-00001 | GV METIS | 334 | 350 | - | 8,5 | 50/90 | 178 | 5 | 18 | - | 1130x710x1110 | 110 | 286,60 | 1 |
| 45013-00001 | GV KOLUMBO | 336 | 350 | - | 8,5 | 50/90 | 178 | 5 | 25 | 2,5 | 1300x780x1080 | 140 | 308,64 | 1 |
| 45013-00020 | GV KOLUMBO cordless | 336 | 350 | - | 8,5 | 50/90 | 178 | 5 | 25 | 2,5 | 1300x780x1080 | 140 | 308,64 | 1 |
| 45013-00012 | GV KOLUMBO 2 Ways | 336 | 350 | - | 8,5 | 50/90 | 178 | 5 | 25 | 2,5 | 1300x780x1080 | 140 | 308,64 | 1 |
| 45013-00022 | GRAFFITI WASTER | 338 | 350 | - | 8,5 | 50/90 | 178 | 5 | 25 | 2,5 | 1500x1300x780 | 182 | 401 | 1 |



GV Kone



MORE INFO



CHARACTERISTICS

- Saturated steam at 4 bar at a temperature of 143°C • Boiler 2,3 kW • Heating and activation time required: 10 min • Pressure switch
- Double thermostat • Cap with protection against anti-unscrewing and safety valve • Handy accessory compartment with electric cable holder • Control panel with lamps • Impact resistant covers • Steam regulation • Thermometer • Power cable 6 m.

TECHNICAL DATA

| | GV Kone |
|--------------------------------|---------------------------|
| code | 45001-00005 |
| max steam pressure/temperature | 4 bar/143° C |
| boiler absorbed power | 2300 W/220-240V ~ 50/60Hz |
| steam production | 2,6 kg/h max |
| boiler type/volume | Alluminium/2,4 l |
| dimension (cm)/weight | 46x32x32/7,5 kg |

PLUS



Lavor steam cleaner GV Kone sanitizes and sterilizes every surface with steam power, without using detergents or disinfectants. GV Kone is environmental friendly.



Steam regulation allows washing adjusting considering the surface to be treated: in this way every kind of surface has the right treatment.



The machine is user friendly and has a wide range of accessories: GV Kone is a comfortable and safe daily working tool.



Steam cleaning function is perfect in shops, premises, offices as well as in household application and removes the toughest and hidden dirt while eliminating mites, germs and bacteria.

STANDARD EQUIPMENT

| | | | | |
|---|--|---|---|---|
|  <ul style="list-style-type: none"> • Hose 2,8 m |  <ul style="list-style-type: none"> • 2x 00080-02896 |  <ul style="list-style-type: none"> • 00080-02874 |  <ul style="list-style-type: none"> • 00080-04371 |  <ul style="list-style-type: none"> • 00080-02875 |
|  <ul style="list-style-type: none"> • 00080-04372 |  <ul style="list-style-type: none"> • 00080-02926 |  <ul style="list-style-type: none"> • 00080-03753 |  <ul style="list-style-type: none"> • 00054-01389 |  <ul style="list-style-type: none"> • 00032-00339 |
|  <ul style="list-style-type: none"> • 00080-04692 |  <ul style="list-style-type: none"> • 10001-10731 | | | |

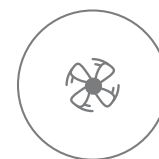
GV Egon VAC 4.1 Plus

MORE INFO

**CHARACTERISTICS**

• ABS body • Ready steam warning lamp • Boiler 1,9 kW Stainless steel AISI 304 • Low level water lamp indicator • Boiler is refilled continuously • Flex hose 2 m • Wheels suitable for use in food processing area • ON/OFF main switch with indicator lamp • ON/OFF boiler switch with indicator lamp • Steam regulation • Recovery tank capacity 8 l. • Washable filter • HEPA filtering system H14 cod. 00070-00605 • Pressure gauge. • Suction speed control (4 level) on handle

TECHNICAL DATA

| | GV Egon VAC 4.1 Plus |
|--------------------------------|----------------------------------|
| code | 45002-00003 |
| max steam pressure/temperature | 5 bar/152° C |
| boiler absorbed power | 1900 W/220-240V ~ 50/60Hz (Ph 1) |
| vacuum motor absorbed power | 1200 (max 1400) W |
| column depression/air flow | 24 kPa/220 m ³ /h |
| recovery tank capacity | 8 l |
| dimension (cm)/weight | 55x40x35/14,3 kg |

PLUS



User friendly control panel with ON/OFF main switch and steam ready light. Equipped with stainless steel boiler with unlimited autonomy, ready in a few minutes



Egon Vac 4.1 is equipped with an HEPA H14 filter which remove the 99.995% of the air contaminants preventing the spread of bacterial and viral organism present in the air.











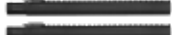











Steam regulation directly from the gun



Fully removable recovery tank for easy emptying and perfect tank cleaning

STANDARD EQUIPMENT

| | | | | |
|--|--|--|--|--|
|  • 10002-06232 |  • 2 X 00080-01883 |  • 00080-02052 |  • 00071-02658 |  • 00071-02659 |
|  • 00071-02660 |  • 00080-03750 PEK |  • 00080-03752 Stainless steel |  • 00080-03751 Brass |  • 00080-02911 |
|  • 00080-02061 |  • 00071-02668 |  • 00071-02669 |  • 00080-01912 |  • 10001-08349 |
|  • 00080-01980 |  • 00080-04382 |  • 00080-02077 |  • 10001-10694 |  • 00080-02076 |
|  • 00009-02541 |  • 00080-03121 | | | |

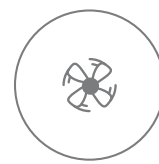
GV Etna-R 5.1

MORE INFO

**CHARACTERISTICS**

• Stainless steel body AISI 304 • Ready steam warning lamp • Boiler 3 kW Stainless steel AISI 304 - Thickness 25/10 • Low level water lamp indicator • Boiler is refilled continuously • Switch for using chemicals and detergents mixed with steam • Device for cleaning hot water mixed with steam • Washable filter • Flex hose 4 m • Recovery tank capacity 64 l • Drain hose system • Steam regulation • Wheels suitable for use in food processing area • ON/OFF main switch with indicator lamp • ON/OFF boiler switch with indicator lamp • Boiler volume 4,3 l • Suction control on handle (model GV etna-R 5.1) with low tension control.

TECHNICAL DATA

| | GV Etna-R 5.1 | GV Etna-R 5.1 FR |
|--|----------------------------------|----------------------------------|
| code | 45004-00033 | 45004-00037 |
| max steam pressure/temperature/ steam production | 7 bar/165° C/3,25 kg/h | 7 bar/165° C/3,25 kg/h |
| boiler absorbed power | 3000 W/220-240V ~ 50/60Hz (Ph 1) | 3000 W/220-240V ~ 50/60Hz (Ph 1) |
| vacuum motor absorbed power | 1100 W | 1100 W |
| column depression/air flow | 22 kPa/220 m ³ /h | 22 kPa/220 m ³ /h |
| water tank/detergent tank capacity | 5 l/5 l | 5 l/5 l |
| dimension (cm)/weight | 75x60x103/32 kg | 75x60x103/35 kg |

PLUS



Simple and intuitive control panel, quick-coupling steam gun, main ON/OFF switch with lamp, boiler ON/OFF switch with lamp, steam/detergent regulator/selector, steam flow rate regulator, steam ready warning lamp, low level water indicator lamp with buzzer, steam pressure gauge.



Unlimited autonomy thanks to the continuous power supply of the boiler, which enables water top-ups in the tank without having to stop the machine or interrupt work. Discharge pipe to quickly drain dirty water collected without removing the head.



Two electronic alarms, standby inactivity after 30 min. Maximum safety thanks to the 2 safety thermostats, 1 pressure switch and 1 mechanical maximum pressure valve.



Recommended for hospitality, community & healthcare like buildings cleaning, spa & sport, education & community, healthcare or industry, transportation, car washers, car dealers.

STANDARD EQUIPMENT

| | | | | |
|---|---|---|---|---|
|  <ul style="list-style-type: none"> • 10002-06216 Hose 4 m (mod. GV Etna 5.1) • 10002-06204 Hose 4 m (mod. GV Etna 5.1 FR) |  <ul style="list-style-type: none"> • 2 x 00080-01894 |  <ul style="list-style-type: none"> • 00009-02540 |  <ul style="list-style-type: none"> • 00080-01912 |  <ul style="list-style-type: none"> • 00080-02020 |
|  <ul style="list-style-type: none"> • 00071-02658 |  <ul style="list-style-type: none"> • 00071-02659 |  <ul style="list-style-type: none"> • 00071-02660 |  <ul style="list-style-type: none"> • 10001-09774 |  <ul style="list-style-type: none"> • 00080-02022 |
|  <ul style="list-style-type: none"> • 00080-02034 |  <ul style="list-style-type: none"> • 00071-02665 |  <ul style="list-style-type: none"> • 00071-02666 |  <ul style="list-style-type: none"> • 00080-02027 |  <ul style="list-style-type: none"> • 00080-02055 |
|  <ul style="list-style-type: none"> • 00080-02061 |  <ul style="list-style-type: none"> • 10001-08263 | <ul style="list-style-type: none"> • 00005-02174 Sponge accessory | | |

GV Etna-R 5.1 Foam

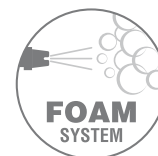
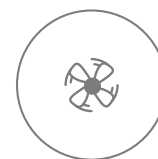

MORE INFO



CHARACTERISTICS

- Stainless steel body AISI 304
- Ready steam warning lamp
- Boiler 3 kW stainless steel AISI 304 - Thickness 25/10
- Low level water lamp indicator
- Boiler is refilled continuously
- Switch for using chemicals and detergents mixed with steam
- Device for cleaning hot water mixed with steam
- Washable filter
- Flex hose 4 m
- Recovery tank capacity 64 l
- Drain hose system
- Steam regulation
- Wheels suitable for use in food processing area
- ON/OFF main switch with indicator lamp
- ON/OFF boiler switch with indicator lamp
- Boiler volume 4,3 l
- Suction control on handle with low tension control.

TECHNICAL DATA

| | GV Etna-R 5.1 Foam |
|--|----------------------------------|
| code | 45004-00036 |
| max steam pressure/temperature/ steam production | 7 bar/165° C/3,25 kg/h |
| boiler absorbed power | 3000 W/220-240V ~ 50/60Hz (Ph 1) |
| vacuum motor absorbed power | 1100 W |
| column depression/air flow | 22 kPa/220 m³/h |
| water tank/detergent tank capacity | 5 l/5 l |
| dimension (cm)/weight | 75x60x103/36 kg |

PLUS



New simple and intuitive control panel, quick-coupling steam gun, steam function/compressed air function selector, water/detergent selector, steam flow rate regulator, steam ready indicator lamp, low water level indicator lamp with buzzer, steam pressure gauge, and air pressure gauge.



Multipurpose machine: cleaning with detergent, steam, steam with detergent, foam and hot water. Equipped with a compressed air connection and pressure gauges for air and steam. Unlimited autonomy of steam thanks to the electronically controlled power supply of the boiler.



Recommended for hospitality, community & healthcare like buildings cleaning, spa & sport, education & community, healthcare or industry, transportation, car washers, car dealers.



Recommended for car dealers, car washers, garages, car body shops, and every other place where a source of compressed air is already available

STANDARD EQUIPMENT

| | | | | |
|---|--|--|--|--|
|  <ul style="list-style-type: none"> • 10002-06216 Hose 4 m |  <ul style="list-style-type: none"> • 2 x 00080-01894 |  <ul style="list-style-type: none"> • 00009-02540 |  <ul style="list-style-type: none"> • 00080-01912 |  <ul style="list-style-type: none"> • 00080-03096 |
|  <ul style="list-style-type: none"> • 00080-03748 |  <ul style="list-style-type: none"> • 10001-09774 |  <ul style="list-style-type: none"> • 00080-02022 |  <ul style="list-style-type: none"> • 00080-02034 |  <ul style="list-style-type: none"> • 00071-02665 |
|  <ul style="list-style-type: none"> • 00071-02666 |  <ul style="list-style-type: none"> • 00080-02027 |  <ul style="list-style-type: none"> • 00080-02055 |  <ul style="list-style-type: none"> • 00080-02061 |  <ul style="list-style-type: none"> • 10001-08263 |
| <ul style="list-style-type: none"> • 00005-02174 Sponge accessory | <ul style="list-style-type: none"> • 00073-00142 1l. LC prefoam | | | |

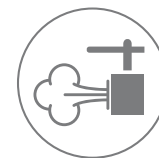
GV Katla

MORE INFO

**CHARACTERISTICS**

- Saturated steam at 9 bar at a temperature of 175°C • Steam gun with low tension control • Stainless steel body AISI 304 • Boiler 3,3 kW Stainless steel AISI 304. Thickness 25/10 • Low level water lamp indicator • Device for using chemicals and detergents mixed with steam
- Heating and activation time required: 7 min. • Steam regulation • Discharge valve • Pressure gauge • The boiler can be refilled from the tank provided (continuous duty) • Wheels suitable for food and processing areas • Storage basket.

TECHNICAL DATA

| | GV Katla |
|------------------------------------|----------------------------------|
| code | 45006-00001 |
| max steam pressure/temperature | 9 bar/175° C |
| boiler absorbed power | 3300 W/220-240V ~ 50/60Hz (Ph 1) |
| steam production | 4,62 kg/h |
| boiler type/volume | Inox AISI 304/4,6 l |
| water tank/detergent tank capacity | 5 l/5 l |
| dimension (cm)/weight | 43x62x91/27 kg |

PLUS



Simple and intuitive control panel, quick-coupling steam gun, water/detergent selector, steam flow rate regulator, steam ready indicator lamp, low water level indicator lamp with buzzer, steam pressure gauge. Steam gun with integrated steam/detergent function activation key and quick coupling of accessories.



Unlimited autonomy thanks to the continuous power supply of the boiler, which enables water top-ups in the tank without having to stop the machine or interrupt work, with major time saving in the operating phase. Boiler with saturated steam at 9 bar at a temperature of 175°C. Equipped with 3 pumps: boiler, detergent and water.



Discharge valve for complete discharge of the boiler; it eliminates water residues and formation of lime scale, thus lengthening the lifespan of the boiler. A 5-litre water and detergent double tank. A rich and complete range of accessories is supplied.



Recommended for hospitality, community & healthcare like buildings cleaning, spa & sport, education & community, healthcare or industry, transportation, car washers, car dealers.

STANDARD EQUIPMENT

| | | | | |
|---|--|--|--|--|
|  • 10002-06391 Hose 3 m |  • 2 x 00080-01873 |  • 00080-04317 |  • 00080-04318 |  • 00080-02040 |
|  • 00080-02049 |  • 00080-02039 |  • 10001-09769 |  • 00080-04382 |  • 00080-04322 |
|  • 00080-02911 |  • 00080-04692 | | | |

OPTIONAL

| | | | | |
|--|--------------------------------|--|--|--|
| • 10002-06389 Steam gun with hose (10 m) | • 00080-02065 Long steam lance | | | |
|--|--------------------------------|--|--|--|

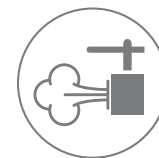
GV 3 M Plus/GV 3,3 M Plus

MORE INFO

**CHARACTERISTICS**

• Saturated steam at 9 bar at a temperature of 175°C • Steam gun with low tension control • Made of AISI 304 stainless steel • Boiler stainless steel AISI 304. Thickness 25/10 • Heating and activation time required: 7 min. (model GV 3,3 M Plus) • Steam regulation • Discharge valve • Pressure gauge • Device for using chemicals and detergents mixed with steam • The boiler can be refilled from the tank provided (continuous duty) • Pivoting wheels with brakes, suitable for use in food processing areas.

TECHNICAL DATA

| | GV 3 M PLUS | GV 3,3 M PLUS |
|------------------------------------|----------------------------------|----------------------------------|
| code | 45003-00038 | 45003-00010 |
| max steam pressure/temperature | 9 bar/175° C | 9 bar/175° C |
| boiler absorbed power | 3000 W/220-240V ~ 50/60Hz (Ph 1) | 3300 W/220-240V ~ 50/60Hz (Ph 1) |
| steam production | 4.2 kg/h | 4.62 kg/h |
| boiler type/volume | Inox AISI 304/4,6 l | Inox AISI 304/4,6 l |
| water tank/detergent tank capacity | 5 l/5 l | 5 l/5 l |
| dimension (cm)/weight | 62x40x86/26,5 kg | 62x40x86/26,5 kg |

PLUS



Simple and intuitive control panel, quick-coupling steam gun, main ON/OFF switch with lamp, boiler resistance activation lamp, steam flow rate regulator, steam ready indicator lamp, steam pressure gauge.



Unlimited autonomy thanks to the continuous power supply of the boiler, which enables water top-ups in the tank without having to stop the machine or interrupt work, with major time saving in the operating phase. Boiler with saturated steam at 9 bar at a temperature of 175°C. Equipped with 2 pumps: boiler and detergent.



Maximum safety thanks to the 1 safety thermostat, 1 pressure switch and 1 mechanical maximum pressure valve. Discharge valve for complete discharge of the boiler; it eliminates water residues and formation of lime scale, thus lengthening the lifespan of the boiler.



Equipped with 4 pivoting wheels suitable for food environments.

STANDARD EQUIPMENT

| | | | | |
|---|--|--|--|--|
|  • 10002-06391 Hose 3 m |  • 2 x 00080-01873 |  • 00080-04317 |  • 00080-04318 |  • 00080-02040 |
|  • 00080-02049 |  • 00080-02039 |  • 10001-09769 |  • 00080-04382 |  • 00080-04322 |
|  • 00080-02911 |  • 00080-04692 | | | |

OPTIONAL

| | | | | |
|--|--------------------------------|--|--|--|
| • 10002-06389 Steam gun with hose (10 m) | • 00080-02065 Long steam lance | | | |
|--|--------------------------------|--|--|--|

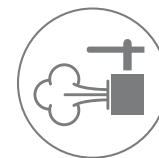
GV 5 T Plus/GV 8 T Plus

MORE INFO

**CHARACTERISTICS**

• Built-in AISI 304 stainless steel • Pivoting wheels with brakes, suitable for use in food processing areas • The boiler can be refilled from the tank provided (continuous duty) • Discharge valve • Pressure gauge • Device for using chemicals and detergents mixed with steam • Heating and activation time required: 6 min. • Control with low tension controls • Control panel: ON-OFF main switch, indicator lamp, • Saturated steam at 9 bar at a temperature of 175°C.

TECHNICAL DATA

| | GV 5 T PLUS | GV 8 T PLUS |
|------------------------------------|----------------------------------|----------------------------------|
| code | 45010-00006 | 45010-00001 |
| max steam pressure/temperature | 9 bar/175° C | 9 bar/175° C |
| boiler absorbed power | 5000 W/380-400V ~ 50/60Hz (Ph 3) | 8000 W/380-400V ~ 50/60Hz (Ph 3) |
| steam production | 8 kg/h | 13,50 kg/h |
| boiler type/volume | Inox AISI 304/4,6 l | Inox AISI 304/4,6 l |
| water tank/detergent tank capacity | 10 l/5 l | 10 l/5 l |
| dimension (cm)/weight | 62,5x37,5x86/32 kg | 62,5x37,5x86/32 kg |

PLUS



Simple and intuitive control panel, quick-coupling steam gun, main ON/OFF switch with lamp, boiler resistance activation lamp, steam flow rate regulator, steam ready indicator lamp, steam pressure gauge.



Unlimited autonomy thanks to the continuous power supply of the boiler, which enables water top-ups in the tank without having to stop the machine or interrupt work, with major time saving in the operating phase. Boiler with saturated steam at 9 bar at a temperature of 175°C. Equipped with 2 pumps: boiler and detergent.









Maximum safety thanks to the 1 safety thermostat, 1 pressure switch and 1 mechanical maximum pressure valve. Discharge valve for complete discharge of the boiler; it eliminates water residues and formation of lime scale, thus lengthening the lifespan of the boiler.



Equipped with 4 pivoting wheels suitable for food environments.

STANDARD EQUIPMENT

| | | | | |
|---|--|--|---|--|
|  • 00080-02898 Hose 3,5 m |  • 00080-02900 |  • 00080-02899 |  • 00080-02901 |  • 10001-09741 |
|  • 00080-02883 |  • 00080-02893 | • 00080-03601 Steam nozzle | | |

OPTIONAL

| | | | | |
|---|--|--|--------------------------------|--------------------------------------|
| • 00080-02904 Steam gun with hose (6 m) | • 00080-02903 Steam gun with hose (10 m) | • 00080-02908 Straight lance mm 750 without nozzle | • 00080-02910 Extension 650 mm | • 00080-02912 Lance with flat nozzle |
| • 00080-04383 Brass bristles brush Ø 80 | • 00080-02922 Lance for barrel | | | |

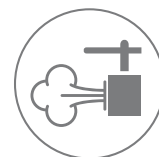
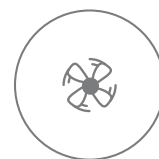
GV 3.0 Vac

MORE INFO

**CHARACTERISTICS**

- Saturated steam at 8 bar at a temperature of 170°C • Steam gun with low tension control • Made of AISI 304 stainless steel • Boiler 3,0 kW stainless steel AISI 304. Thickness 25/10 • Complete warm-up and activation phase: 7/8 min • Vacuum system • Steam regulation
- Pressure gauge • Washing device with hot water mixed with steam • The boiler can be refilled from the tank provided (continuous duty)
- Pivoting wheels with brakes (suitable for use in food processing areas.)

TECHNICAL DATA

| | GV 3.0 Vac |
|------------------------------------|----------------------------------|
| code | 45012-00003 |
| max steam pressure/temperature | 8 bar/170° C |
| boiler absorbed power | 3000 W/220-240V ~ 50/60Hz (Ph 1) |
| vacuum motor absorbed power | 1100W |
| column depression/air flow | 22 kPa/2200 mmH ₂ O |
| steam production | 4.2 kg/h |
| boiler type/volume | Inox AISI 304/4,6 l |
| water tank/detergent tank capacity | 5 l/5 l |
| dimension (cm)/weight | 86x39,6x101,1/35 kg |

PLUS



Practical accessory compartment with integrated water and detergent tank system



New control panel with ON/OFF main switch, boiler ON/OFF switch, detergent selector, hot water selector, "NO WATER" light, "STEAM READY" light, steam adjustment, steam pressure gauge



Integrated suction system with stainless steel tank, tank capacity 20 litres, vacuum motor power 1100W, air flow 22 kPa



Sturdy tubular varnished steel, shock proof trolley with pivoting front wheels for easy movement

STANDARD EQUIPMENT

| | | | | |
|--|--|--|--|--|
|  • 10002-06251 Steam/vacuum hose 4 m |  • 00080-01894 |  • 00009-02540 |  • 00080-01912 |  • 00080-02020 |
|  • 00080-03751 |  • 00080-03750 |  • 00080-03752 |  • 00071-02659 |  • 00071-02658 |
|  • 00071-02660 |  • 00080-02022 |  • 00080-02034 |  • 00071-02665 |  • 00071-02666 |
|  • 00080-02027 |  • 00080-02055 |  • 00080-02061 |  • 00070-00606 | |

OPTIONAL

| | | | | |
|---|--------------------------------|--|--|--|
| • 10002-06389 Steam gun with hose 10 m (only steam) | • 00080-02065 Long steam lance | | | |
|---|--------------------------------|--|--|--|

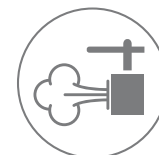
GV Vesuvio

MORE INFO

**CHARACTERISTICS**

• Built-in AISI 304 stainless steel • Pivoting wheels with brakes, suitable for use in food processing areas • The boiler can be refilled from the tank provided (continuous duty) • Temperature regulator, discharge valve and pressure gauge • Device for using chemicals and detergents mixed with steam • Control with low tension controls • Control panel: ON-OFF main switch, indicator lamp, thermoregulator, boiler activating key, gun activating key • Timer cycle.

TECHNICAL DATA

| | GV Vesuvio 10 | GV Vesuvio 15 | GV Vesuvio 18 | GV Vesuvio 21 | GV Vesuvio 30 |
|------------------------------------|-----------------------------|-----------------------------|-----------------------------|-----------------------------|-----------------------------|
| code | 45005-00010 | 45005-00029 | 45005-00002 | 45005-00030 | 45005-00001 |
| max steam pressure/temperature | 10 bar/180° C | 10 bar/180° C | 10 bar/180° C | 10 bar/180° C | 10 bar/180° C |
| boiler absorbed power | 10000 W/400V~50/60Hz (Ph 3) | 15000 W/400V~50/60Hz (Ph 3) | 18000 W/400V~50/60Hz (Ph 3) | 21000 W/400V~50/60Hz (Ph 3) | 30000 W/400V~50/60Hz (Ph 3) |
| steam production | 14,8 kg/h | 22,2 kg/h | 26.5 kg/h | 31 kg/h | 44.5 kg/h |
| boiler type/volume | Inox AISI 304/18 l | Inox AISI 304/18 l | Inox AISI 304/18 l | Inox AISI 304/18 l | Inox AISI 304/18 l |
| water tank/detergent tank capacity | 25 l/5 l | 25 l/5 l | 25 l/5 l | 25 l/5 l | 25 l/5 l |
| dimension (cm)/weight | 114x52,5x91,5/103 kg | 114x52,5x91,5/103 kg | 114x52,5x91,5/103 kg | 114x52,5x91,5/103 kg | 114x52,5x91,5/103 kg |

PLUS



Simple and intuitive control panel, quick-coupling steam gun, main ON/OFF switch, activation lamp, electronic regulator of the temperature with digital display, low water level display with buzzer, boiler activation key, gun activation key, steam pressure gauge, steam selector and detergent selector. Steam gun with integrated steam/detergent function activation key and quick coupling of accessories. Timer cycle.



Unlimited autonomy thanks to the continuous power supply of the boiler, which enables water top-ups in the tank without having to stop the machine or interrupt work, with major time saving in the operating phase. Boiler with saturated steam at 10 bar at a temperature of 180°C. Equipped with 2 pumps: detergent and water. Maximum safety thanks to the 2 level controls, 2 thermostat, 1 pressure switch and 1 mechanical pressure valve.









Discharge valve for complete discharge of the boiler; it eliminates water residues and formation of lime scale, thus lengthening the lifespan of the boiler.



Double tank: 25 litres for water and 5 litres for detergent. Equipped with 2 pivoting wheels and appropriate brake to use in food environments + 2 fixed wheels. A rich and complete range of accessories is supplied with practical accessory holders.

STANDARD EQUIPMENT

| | | | | |
|---|--|--|--|--|
|  • 00080-02898 Hose 3,5 m |  • 00080-02900 |  • 00080-02899 |  • 00080-02901 |  • 10001-09741 |
|  • 00080-02883 |  • 00080-02893 | • 00080-03601 Steam nozzle (GV Vesuvio 10) • 00080-03602 Steam nozzle (GV Vesuvio 15) | • 00080-03603 Steam nozzle (GV Vesuvio 18/GV Vesuvio 21) • 00080-03605 Steam nozzle (GV Vesuvio 30) | |

OPTIONAL

| | | | | |
|--|--|--|--|---------------------------------------|
| • 00080-02904 Steam gun with hose (6 m) | • 00080-02903 Steam gun with hose (10 m) | • 00080-02908 Straight lance mm 750 without nozzle | • 00080-02907 Steam gun with hose (20 m) | • 10001-10374 Coupling for tanks Ø 40 |
| • 00080-02909 Steam gun with hose (15 m) | • 00080-02910 Extension 650 mm | • 00080-02912 Lance with flat nozzle | • 00080-04383 Brass bristles brush Ø 80 | • 00080-02922 Lance for barrel |

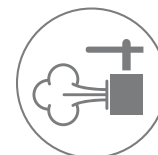
Metis

MORE INFO

**CHARACTERISTICS**

• Vertical burner with high thermal efficiency steel coil • Auxiliary motor for burner • Discharge valve: allows a complete discharge of the boiler • Temperature regulator: the temperature is set-up by an electronic regulator • Steam pressure gauge • Low fuel indicator • Double pipe gasoil pump • User-friendly control panel • Unit can be continually refilled • Provided with 2 outputs for simultaneous work of two different operators.

TECHNICAL DATA

| | Metis |
|--------------------------------|-----------------------------------|
| code | 45009-00001 |
| max steam pressure/temperature | 10 bar / 178° C |
| absorbed power | 350 W / 220/240V ~ 50/60Hz (Ph 1) |
| steam production dry/wet | 50/90 kg/h |
| burner type/fuel consumption | Diesel / 2,83 l/h |
| water tank/fuel tank capacity | 18 l / 18 l |
| dimension (cm)/weight | 94x65x90/87,5 kg |

PLUS



Metis is a portable steam generator with a diesel fuel boiler. Unlimited autonomy thanks to no-stop water tank refilling. It does not leave any residues after cleaning. Metis water saving (over 90%) compared to normal high-pressure systems. Allows sanitisation tasks thanks to the combined use of steam and pressure. The operator does not require special protective overalls and protective masks.



Ideal for maintenance cleaning and makes the bodywork of your car or motorbike shine without the risk of damaging it with the mechanical action of the high-pressure water. Ideal for eliminating stubborn grease and dirt, leaving surfaces clean and shining. Cleaning is easy, all you need to do is use the cleaning and degreasing action of the steam at high temperature and collect residues with a microfibre cloth.







Provided with 2 outputs for simultaneous work of two different operators. Portability: it does not need to be connected neither to the water supply because it is equipped with a water tank. It is easy to move around, easy to use, and ready to use. The advantages compared to normal high-pressure washing



Ecological: It consumes very little water (90% less than normal high-pressure cleaners) and does not require connection to the water supply. Glass and delicate surfaces. Car interiors and for the most difficult parts to reach. Quick, thorough cleaning and sanitisation of mats without wetting them. It does not require a collection tank to dispose of water reflux. Thanks to the high temperature that degreases and dissolves

STANDARD EQUIPMENT

| | | | | |
|---|---|---|--|--|
|  <ul style="list-style-type: none"> • 00080-02915 Hose 10 m |  <ul style="list-style-type: none"> • 00080-02900 |  <ul style="list-style-type: none"> • 10001-09741 |  <ul style="list-style-type: none"> • 00080-03605 Steam nozzle | |
|---|---|---|--|--|

OPTIONAL

| | | | | |
|---|--|---|---|---|
| <ul style="list-style-type: none"> • 00080-02916 Steam gun with hose (15 m) | <ul style="list-style-type: none"> • 00080-02917 Steam gun with hose (20 m) | <ul style="list-style-type: none"> • 00080-02908 Lance mm 750 without nozzle | <ul style="list-style-type: none"> • 00080-02899 Lance mm 175 without nozzle | <ul style="list-style-type: none"> • 00080-02901 Lance mm 425 without nozzle |
| <ul style="list-style-type: none"> • 00080-02883 Black plastic scraper l. 50 | <ul style="list-style-type: none"> • 00080-02893 Glass wiper | <ul style="list-style-type: none"> • 00080-02910 Extension 650 mm | <ul style="list-style-type: none"> • 00080-02912 Lance with flat nozzle | <ul style="list-style-type: none"> • 00080-04383 Brass bristles brush Ø 80 |
| <ul style="list-style-type: none"> • 00080-02922 Lance for barrel | | | | |

Kolumbo

Kolumbo 2way
With double guns
for two operators

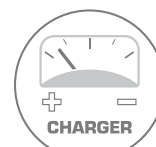
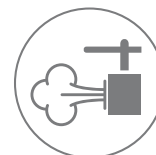

Model:
Cordless



Model:
Cordless

MORE INFO



CHARACTERISTICS

- Vertical burner with high thermal efficiency steel coil • Auxiliary motor for burner • Discharge valve: allows a complete discharge of the boiler
- Temperature regulator: the temperature is set-up by an electronic regulator • Steam pressure gauge, temperature regulator and low fuel lamp
- Integrated detergent tank with detergent delivery controller by the gun • Double pipe gasoil pump • User-friendly control panel • Unit can be continually refilled • Standard with double guns for 2 operators model Kolumbo 2Way code 45013-00012 • Battery version: Kolumbo Cordless code 45013-00020 (Battery charger 220/240V - 50/60Hz included).

TECHNICAL DATA

| | Kolumbo | Kolumbo cordless | Kolumbo 2way |
|--------------------------------|-----------------------------------|----------------------------|-----------------------------------|
| code | 45013-00001 | 45013-00020 | 45013-00012 |
| max steam pressure/temperature | 10 bar / 178° C | 10 bar / 178° C | 10 bar / 178° C |
| absorbed power | 350 W / 220/240V ~ 50/60Hz (Ph 1) | 350 W / 1 x 12 DC 75 Ah C5 | 350 W / 220/240V ~ 50/60Hz (Ph 1) |
| steam production dry/wet | 50/90 kg/h | 50/90 kg/h | 50/90 kg/h |
| burner type/fuel consumption | Diesel / 2,83 l/h | Diesel / 2,83 l/h | Diesel / 2,83 l/h |
| water tank/fuel tank capacity | 25 l / 25 l | 25 l / 25 l | 25 l / 25 l |
| dimension (cm)/weight | 125x69x87/120 kg | 125x69x87/150 kg | 125x69x87/140 kg |

PLUS



Kolumbo is a portable steam generator with a diesel fuel boiler. Unlimited autonomy thanks to no-stop water tank refilling. It does not leave any residues after cleaning. Water saving (over 90%) compared to normal high-pressure systems. Allows sanitisation tasks thanks to the combined use of steam and pressure.



It does not need to be connected to the water supply because it is equipped with a water tank. It is easy to move around, easy to use, and ready to use.

Ecological: It consumes very little water (90% less than normal high-pressure cleaners) and does not require connection to the water supply. • It does not require a collection tank to dispose of water reflux. • Easy to use where required, it does not require connection to the water supply, the operator does not require special work clothing, excess water is not wasted. • Ideal for maintenance cleaning and makes the bodywork of your car or motorbike shine without the risk of damaging it with the mechanical action of the high-pressure water.

It is ideal for: eliminating stubborn grease and dirt, leaving surfaces clean and shining. Cleaning is easy, all you need to do is use the cleaning and degreasing action of the steam at high temperature and collect residues with a microfibre cloth perfect for glass and delicate surfaces, car interiors and for the most difficult parts to reach.

Available: version with hose 20 m. cod. 45013-00034

STANDARD EQUIPMENT

| | | | | |
|---|---|---|---|--|
|  <ul style="list-style-type: none"> • 00080-02903 Hose 10 m (Kolumbo 2way - Two pieces) |  <ul style="list-style-type: none"> • 00080-02900 (Kolumbo 2way - Two pieces) |  <ul style="list-style-type: none"> • 10001-09741 (Kolumbo 2way - Two pieces) | <ul style="list-style-type: none"> • 00080-03605 Steam nozzle (Kolumbo/Kolumbo cordless) | <ul style="list-style-type: none"> • 00080-03603 Steam nozzle (Kolumbo 2 way) |
|---|---|---|---|--|

OPTIONAL

| | | | | |
|---|---|---|--|---|
| <ul style="list-style-type: none"> • 00080-02898 Steam gun with hose (3,5 m) | <ul style="list-style-type: none"> • 00080-02904 Steam gun with hose (6 m) | <ul style="list-style-type: none"> • 00080-02909 Steam gun with hose (15 m) | <ul style="list-style-type: none"> • 00080-02907 Steam gun with hose (20 m) | <ul style="list-style-type: none"> • 00080-02908 Lance mm 750 without nozzle |
| <ul style="list-style-type: none"> • 00080-02899 Lance mm 175 without nozzle | <ul style="list-style-type: none"> • 00080-02901 Lance mm 425 without nozzle | <ul style="list-style-type: none"> • 00080-02883 Black plastic scraper l. 50 | <ul style="list-style-type: none"> • 00080-02893 Glass wiper | <ul style="list-style-type: none"> • 00080-02910 Extension 650 mm |
| <ul style="list-style-type: none"> • 00080-02912 Lance with flat nozzle | <ul style="list-style-type: none"> • 00080-04383 Brass bristles brush Ø 80 | <ul style="list-style-type: none"> • 00080-02922 Lance for barrel | | |

Graffiti Waster

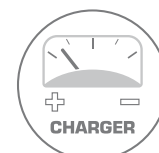
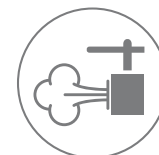

MORE INFO



CHARACTERISTICS

- Vertical burner with high thermal efficiency steel coil • Auxiliary motor for burner • Discharge valve: allows a complete discharge of the boiler
- Temperature regulator: the temperature is set-up by an electronic regulator • Steam pressure gauge, temperature regulator and Low fuel lamp
- Integrated detergent tank with detergent delivery controller by the gun • Double pipe gasoil pump • User-friendly control panel • Unit can be continually refilled • Battery and battery charger included (Battery charger 220/240V - 50/60Hz).

TECHNICAL DATA

| | Graffiti Waster |
|--------------------------------|----------------------------|
| code | 45013-00022 |
| max steam pressure/temperature | 10 bar / 178° C |
| absorbed power | 350 W / 1 x 12 DC 75 Ah C5 |
| steam production wet/dry | 50/90 kg/h |
| burner type/fuel consumption | Diesel / 2,83 l/h |
| water tank/fuel tank capacity | 25 l / 25 l |
| dimension (cm)/weight | 140x69x87/140 kg |

PLUS



Graffiti Waster is a portable steam generator, equipped with diesel fuel boiler, allowing graffiti and dirt removal in general, thanks to the revolutionary system using steam/sand and steam/detergent mashed together. To remove all types of graffiti away from walls, buildings, floors. To restore and clean statues/monuments. Sandblasting walls and railings.



Clean and sand blasting terracotta tiles, roofing tiles and wood. Pickle machineries and surfaces thanks to a combined use of detergents. Unlimited autonomy: thanks to no-stop water tank refilling.











Main plus in comparison to traditional sand blasting systems using air or water:

- It doesn't leave residuals at the end of cleaning task.
- No water waste.
- Noiseless.
- Allows sanitization tasks thanks to the combined use of steam and detergents.
- The operator doesn't need protective overalls and protective masks with filters.
- Lack of hazardous dust that are pulled down by steam.



It doesn't need to be connected nor to water supply, because it is equipped with water tank, not to the electrical supply, because it has a diesel fuel boiler. Easy to use and always ready to use. Easy to move.

STANDARD EQUIPMENT

| | | | | |
|--|--|--|---|--|
|  <p>• 00080-02903 Hose 10 m</p> |  <p>• 00080-02900</p> |  <p>• 00080-02910</p> |  <p>• 10001-09741</p> |  <p>• 00080-02883</p> |
|  <p>• 00080-02913</p> |  <p>• 00014-01358</p> |  <p>• 00014-01500</p> |  <p>• 00080-03605 Steam nozzle</p> | |

OPTIONAL

| | | | | |
|--|--|---|---|---------------------------------------|
| <p>• 00080-02898 Steam gun with hose (3,5 m)</p> | <p>• 00080-02909 Steam gun with hose (15 m)</p> | <p>• 00080-02907 Steam gun with hose (20 m)</p> | <p>• 00075-00005 Calibrated sand (5 kg)</p> | <p>• 00080-02922 Lance for barrel</p> |
| <p>• 00080-02899 Lance mm 175 without nozzle</p> | <p>• 00080-02901 Lance mm 425 without nozzle</p> | | | |

In order to complete the chemical products supply and to allow a better applicability and effectiveness, the sprayers are the perfect solution when supply wideness, use versatility and dosage saving are taken into consideration.

They are split into two different categories: pneumatic charge and continuous pneumatic charge.



Pneumatic charge sprayers need to be connected to an air compressor to charge the tank and allow the product vaporization without the connection to the air compressor. They work at high-pressures and so they use capacious steel or stainless steel tanks to allow a greater working autonomy.

Continuous pneumatic foam sprayers need a permanent connection to an air compressor; in this way air mixes with the chemical product producing a soft and voluminous foam that persists on surfaces: with a little chemical product, it is possible to treat wider areas or tough dirt (also on ceilings, inclined and/or slippery walls).

They work at high-pressure and so they use capacious steel or stainless steel tanks to allow a greater working autonomy.



The chemical product spraying is a finishing phase of cleaning task with other machines. The choice of the right product considering the kind of cleaning task grants the best result, complying with the environment and the machine that sprays the chemical product. Our chemical products range has been conceived complying with the strictest rules protecting the environment and avoiding the indiscriminating use of products damaging the environment. The right measuring and respect of the instructions we suggest are the best balance of the economical and technical needs of each up-to-date and aware cleaning task.

| Code | Model | Page | Product | Capacity | Recharging | Working pressure | Category | Single packaging weight | Single packaging weight | Single packaging dimensions | Pieces for pallet | Pallet dimensions |
|-------------|--------------|------|--------------|----------|---------------|------------------|----------|-------------------------|-------------------------|-----------------------------|-------------------|-------------------|
| | | | | liters | | bar | | kg | lbs | cm L x l x H | N° | cm L x l x H |
| 10001-10260 | FOAM BOX | 341 | Foam sprayer | - | Air operating | 4 | Box | 5 kg | 11 | 40x40x30 | - | - |
| 41002-00007 | SPRAY NV24 | 342 | Sprayer | 24 | Pneumatic | 6 | Trolley | 17 kg | 38 | 34x34x82 | 18 | 102x102x215 |
| 41002-00008 | SPRAY NV50 | 342 | Sprayer | 50 | Pneumatic | 6 | Trolley | 27 kg | 60 | 47x47x107 | 12 | 141x107x205 |
| 41002-00009 | FOAMJET SV24 | 343 | Foam sprayer | 24 | Air operating | 6 | Trolley | 17 kg | 38 | 34x34x82 | 18 | 102x102x215 |
| 41002-00011 | FOAMJET SX24 | 343 | Foam sprayer | 24 | Air operating | 6 | Trolley | 13 kg | 29 | 34x34x82 | 18 | 102x102x215 |
| 41002-00010 | FOAMJET SV50 | 343 | Foam sprayer | 50 | Air operating | 6 | Trolley | 27 kg | 60 | 47x47x107 | 12 | 141x107x205 |
| 41002-00012 | FOAMJET SX50 | 343 | Foam sprayer | 50 | Air operating | 6 | Trolley | 20 kg | 44 | 47x47x107 | 12 | 141x107x205 |

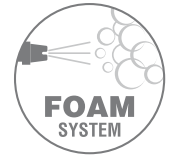
Foam box



STANDARD EQUIPMENT

| | | | | |
|--|--|--|--|--|
|  • 00080-02919 |  • 8m hose 00014-01114 | | | |
|--|--|--|--|--|

OPTIONAL

| | | | | |
|---|--|--|---|--|
| • 00073-00129 4x5 kg foaming cleanser for commercial vehicles | • 00073-00127 4x5 Kg alkaline foaming cleanser for food industry | • 00073-00128 4x5 Kg foaming cleanser for hygiene facilities | • 00073-00126 4x5 kg foaming cleanser for cloth and carpets | |
|---|--|--|---|--|

CHARACTERISTICS

- Device for dense foam production and spreading. Easy to install, it requires only compressed air connection and power supply.
- Ideal for cleaning: car body, car interiors, bathrooms, kitchens, slaughterhouses, food processing areas, health care settings, cellars.

TECHNICAL DATA

| | Foam box |
|-------------------------|-------------------|
| code | 10001-10260 |
| voltage | 220-240V ~ 50Hz |
| pumps no. - power | 2 - 100W |
| air pressure | 4 bar |
| delivery rate | 1 l/m |
| detergent concentration | 4% |
| dimension/weight | 44 x 13 h 25/3 Kg |

Spray

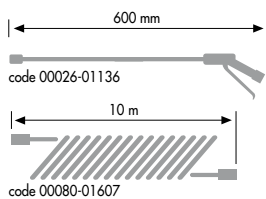

Spray 24

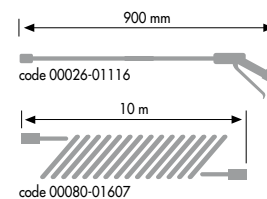

Spray 50

MORE INFO



STANDARD EQUIPMENT

| | | | | |
|---------------------|----------------------|--------------------------------------|---------------------------------|--|
| • Professional gun. | • Lance with nozzle. | • Integrated inlet and outlet quick. | • Chemical use hose and gasket. | |
|---------------------|----------------------|--------------------------------------|---------------------------------|--|

OPTIONAL

| | | | | |
|---|--|--|---|--|
| • 00073-00129 4x5 kg foaming cleanser for commercial vehicles | • 00073-00127 4x5 Kg alkaline foaming cleanser for food industry | • 00073-00128 4x5 Kg foaming cleanser for hygiene facilities | • 00073-00126 4x5 kg foaming cleanser for cloth and carpets | |
|---|--|--|---|--|

CHARACTERISTICS

• **Spray:** Pneumatic charge sprayers need to be connected to an air compressor to charge the tank and allow the product vaporization without the connection to the air compressor. They work at high-pressures and so they use capacious steel or stainless steel tanks to allow a greater working autonomy.

TECHNICAL DATA

| | Spray NV24 | Spray NV50 |
|--------------------|-------------------------------|--------------------------------|
| code | 41002-00007 | 41002-00008 |
| capacity/model | 24 l/painted | 50 l/painted |
| working pressure | 6 bar | 6 bar |
| safety valve | max 8 bar | max 8 bar |
| pressure indicator | pressure gauge | pressure gauge |
| level indicator | external column | external column |
| recharging | pneumatic | pneumatic |
| pressure regulator | manual | manual |
| gun connection | 1/4" G-F | 1/4" G-F |
| hose type | rilsan | rilsan |
| hose/lance lenght | 10 mt/600 mm | 10 mt/900 mm |
| dimension/weight | 28x32x75 cm/15 kg - 33,06 lbs | 45x42x100 cm/25 kg - 55,11 lbs |

Foamjet

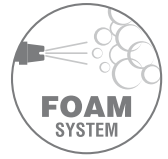

Foamjet 24

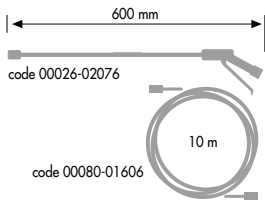

Foamjet 50

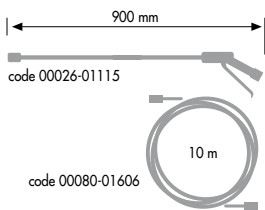

STANDARD EQUIPMENT

| | | | | |
|---------------------|----------------------|--------------------------------------|---------------------------------|--|
| • Professional gun. | • Lance with nozzle. | • Integrated inlet and outlet quick. | • Chemical use hose and gasket. | |
|---------------------|----------------------|--------------------------------------|---------------------------------|--|

CHARACTERISTICS

- Continuous pneumatic foam sprayers need a permanent connection to an air compressor; in this way air mixes with the chemical product producing a soft and voluminous foam that persists on surfaces: with a little chemical product, it is possible to treat wider areas or tough dirt (also on ceilings, inclined and/or slippery walls).
- They work at high-pressure and so they use capacious steel or stainless steel tanks to allow a greater working autonomy.

TECHNICAL DATA

| | Foamjet SV24 | Foamjet SX24 | Foamjet SV50 | Foamjet SX50 |
|--------------------|-------------------------------|-------------------------------|--------------------------------|--------------------------------|
| code | 41002-00009 | 41002-00011 | 41002-00010 | 41002-00012 |
| capacity/model | 24 l/painted | 24 l/Stainless steel | 50 l/painted | 50 l/Stainless steel |
| working pressure | 6 bar | 6 bar | 6 bar | 6 bar |
| safety valve | max 8 bar | max 8 bar | max 8 bar | max 8 bar |
| pressure indicator | pressure gauge | pressure gauge | pressure gauge | pressure gauge |
| level indicator | external column | external column | external column | external column |
| recharging | air operating | air operating | air operating | air operating |
| pressure regulator | manual | manual | manual | manual |
| gun connection | 1/4" G-F | 1/4" G-F | 1/4" G-F | 1/4" G-F |
| hose type | rilsan | rilsan | rilsan | rilsan |
| hose/lance lenght | 10 mt/600 mm | 10 mt/600 mm | 10 mt/900 mm | 10 mt/900 mm |
| dimension/weight | 28x32x75 cm/15 kg - 33,06 lbs | 28x32x75 cm/11 kg - 24,25 lbs | 45x42x100 cm/25 kg - 55,11 lbs | 45x42x102 cm/18 kg - 39,68 lbs |

Technology

T1 manual cleaning T2 sprayer and wheelbarrows T3 carpet cleaner T4 high-pressure cleaner T5 steam cleaner T6 single disc machine T7 floor scrubber-drier

Fields

S1 vehicles S2 mechanical industry S3 food industry S4 building

| MODEL | DESCRIPTION | FIELDS | PROPERTIES | USE: |
|---|-------------------------------------|----------------|--|---|
| LCN-800F code 00073-00096 | FRAGRANCE-FREE SANITISING DETERGENT | S1 S3 S4 | Destroys unpleasant odours, fights the proliferation of bacteria, harmful micro-organisms, fungi and moulds. Contains quaternary ammonium salts. | On all types of hard surface, dilute from 1 to 3%. In the case of tenacious contaminations and aggressive unpleasant odours, dilute up to 6%. |
| Ph 7.8 - 8.2 1,000 g/ml | 5000 ml x 4 pz. | | T1 T2 T3 T5 T7 | |

| MODEL | DESCRIPTION | FIELDS | PROPERTIES | USE: |
|--|--------------------------------|----------------|--|---|
| LCN-800 code 00073-00097 | FRAGRANCE SANITISING DETERGENT | S1 S3 S4 | Destroys unpleasant odours, fights the proliferation of bacteria, harmful micro-organisms, fungi and moulds. Contains quaternary ammonium salts. Leaves a fresh and long-lasting fragrance in the environment. | On all types of hard surface, dilute from 1 to 3%. In the case of tenacious contaminations and aggressive unpleasant odours, dilute up to 6%. |
| Ph 7.8 - 8.2 1,000 g/ml | 5000 ml x 4 pz. | | T1 T2 T3 T5 T7 | |

| MODEL | DESCRIPTION | FIELDS | PROPERTIES | USE: |
|--|---------------------------------|--------|---|--|
| LCN-680AL code 00073-00098 | ALCOHOLIC MAINTENANCE DETERGENT | S4 | Quick-drying universal neutral detergent. Anti-dust effect for 4-5 days. Leaves a pleasant fragrance in the environment. Does not leave residues. | On all types of washable shiny or hard surface such as glass, stone or ceramic, dilute with water from 0.5% to 1%. |
| Ph 6,6 - 7,0 1,000 g/ml | 5000 ml x 4 pz. | | T1 T3 T5 T7 | |

| MODEL | DESCRIPTION | FIELDS | PROPERTIES | USE: |
|--|-------------------------------------|--------|--|---|
| LCN-650 code 00073-00099 | NON ALCOHOLIC MAINTENANCE DETERGENT | S4 | Universal neutral detergent, does not corrode polymers, natural or synthetic waxes. Leaves a pleasant fragrance in the environment. Does not leave residues. | On all types of washable hard surfaces, even if protected by wax and/or sealants, dilute in water to 0.5%-1%. |
| Ph 6,3 - 6,7 1,000 g/ml | 5000 ml x 4 pz. | | T1 T3 T7 | |

| MODEL | DESCRIPTION | FIELDS | PROPERTIES | USE: |
|--|------------------------------------|--------|--|--|
| LCN-640WM code 00073-00100 | NON STRATIFYING WAX WASH DETERGENT | S4 | Cleans and shines surfaces. Regenerates protective and wax treatments. Non filmogenous and leaves a pleasant fragrance in the environment. | On all types of washable hard surfaces, including floors protected by wax and/or sealants, dilute in water to 0.5%-1%. |
| Ph 8,8 - 9,2 1,000 g/ml | 5000 ml x 4 pz. | | T1 T2 T3 T5 T7 | |

Technology

T1 manual cleaning
 T2 sprayer and wheelbarrows
 T3 carpet cleaner
 T4 high-pressure cleaner
 T5 steam cleaner
 T6 single disc machine
 T7 floor scrubber-drier

Fields

S1 vehicles
 S2 mechanical industry
 S3 food industry
 S4 building

| MODEL | DESCRIPTION | FIELDS | PROPERTIES | USE: |
|---|---------------------------------------|--|--|--|
| LCB-900WR code 00073-00103 | FRAGRANCE-FREE WAX REMOVING DETERGENT | S1 S3 S4 | Removes any type of wax or polymer (even if old or stratified). | According to the degree of dirt and the thickness of the film, dilute in water from 1% to 10%. In extreme situations, dilute in water up to 20%. |
| Ph 8,8 - 9,2 1,000 g/ml | 5000 ml x 4 pz. | | T1 T6 T7 | |
| LCB-740F code 00073-00104 | ALKALINE MULTIPURPOSE DETERGENT | S1 S2 S3 S4 | Dissolves and detaches organic and inorganic dirt. | On all types of hard washable surfaces, ceramic or enamelled surfaces, windows and doors, equipment and industrial machine tools. Dilute in water from 1% to 2%. |
| Ph (sol. 1%) 6.9 - 7.9 1,000 g/ml | 5000 ml x 4 pz. | | T1 T2 T4 T7 | |
| LCN-600SVF code 00073-00105 | SOLVENT DETERGENT OF VEGETABLE ORIGIN | S1 S2 S3 S4 | Eliminates tar, rubber, glue and adhesive residues. Removes even stratified (acrylic or polymer) wax films. Disintegrates persistent dirt of animal or mineral origin. | According to the degree of dirt and thickness of the film, dilute in water from 0.5% to 2%. |
| Ph 5,8 - 6,2 0,950 g/ml | 5000 ml x 4 pz. | | T1 T2 T5 T6 T7 | |
| LC 113 GV code 00073-00138 | CARPET AND TEXTILE WASH DETERGENT | S1 | Removes dirt, regenerates and protects fibres. Does not leave residues and releases a pleasant fragrance. | Dilute in water from 2% to 5%. |
| Ph 6.8 - 7.2 1,010 g/ml | 5000 ml x 4 pz. | | T3 T5 | |

Technology

- T2  sprayer T3  carpet cleaner T4  high-pressure cleaner T5  steam cleaner

Fields

- S1  vehicles S3  food industry



CHEMICAL PRODUCTS FOR DENSE FOAM PRODUCTION

LC 104F

- S1  T2  T3  T4  T5 



00073-00129 4x5 kg



Foaming detergent for commercial vehicles

Monocomponent and alkaline detergent based on selected surfactants with a penetrating and softening action against both organic and inorganic dirt. It acts quickly and permanently, leaves no residue, is easy to rinse, does not alter painted parts made of plastic or rubber. Thanks to its high content of sequestrants, it maintains its detergent power even in the presence of hard water. Suitable for self-service high pressure washing plants, it can also be used in washing systems with nebulizer.

LC 102F

- S3  T2  T3  T4  T5 



00073-00127 4x5 kg



Alkaline foaming cleanser for food industry

Alkaline chloroactive fast-acting product, it cleans and sanitizes the surfaces and the equipment which are treated without leaving any residue. Used with a foaming nebulizer, it produces dense foam which sticks on the walls, enhancing its sanitizing action. Also suitable for floors, workbenches, equipment, etc..., it is used in dairy farms, slaughterhouses, salami factories, oil mills.

LC 103F

- S3  T2  T3  T4  T5 



00073-00128 4x5 kg



Foaming cleanser for hygiene facilities

Concentrated liquid detergent with acid pH. Ideal for cleansing stainless steel surfaces, it is used for cleaning and descaling all the acid-resistant surfaces. It effectively removes scale deposits, ferrous oxides and greasy surface dirt making the surfaces clean and without stains.

LC 101F

- S1  T3  T5 



00073-00126 4x5 kg



Foaming cleanser for cloth and carpets

Product indicated for cleaning car interiors made of fabric and of carpet. Formulated with special suspending additives that have the characteristic of breaking the physical-chemical bonds existing between fiber and dirt, attracting the latter to the surface. These substances also avoid the redeposit of dirt guaranteeing excellent cleaning results. Highly foaming, it has to be used with special extraction vacuum cleaners. It brightens the colors and leaves a pleasant perfume.

GENERAL TERMS OF SALE Goods travel at buyer's risk.
Images and technical specifications of products and accessories
are not binding and can be modified without notice.

Follow us on



Lavorwash S.p.A. J.F.Kennedy, 12 - 46020 Pegognaga (MN) Italy
Tel. +39 0376 55431 | info@lavor.com | www.lavor.com

